



مركز البراغي والعدد  
**BTCO**  
BOLTS & TOOLS CENTER



# HANDTOOL CATALOGUE

DURABILITY, INNOVATION & QUALITY

N° 6/2015



# POLAR® TOOL INDEX



## ROLLER CABINETS, ASSORTMENTS AND STORAGE 20-83

**PAGE**

### ROLLER CABINETS 20

- EASY 22-23
- X-LARGE 24-25
- CARGO 26-27
- MINI 28-29, 82

### ROLLER CABINETS WITH TOOLS 38-49

- EASY 38-40
- X-LARGE 42-49
- CARGO 27
- MINI 83

### TOOL ASSORTMENTS 36-77

- SINGLE ASSORTMENTS 50-66
- TOOL TRAY SYSTEM 36-37
- TRIPLE ASSORTMENTS 50, 51, 52, 59, 61, 63
- TOOLSET, 66 PCS. 72
- TOOLSET, 163 PCS. 73
- TOOLSET, 350 PCS. 67
- TOOLSET, 425 PCS. 68
- TOOLSET, 447 PCS. 77
- TOOLSET, 470 PCS. 70-71
- TOOLSET, 473 PCS. 74-75

### STORAGE

- DRAWER CHESTS 30, 81
- SERVICE CART 82
- SIDE CABINETS 31
- TOOL BOX 30, 83
- TOOL HOLDERS/HOOKS 79-80
- TOOL PANELS 78, 81
- WORKBENCH 81

### ACCESSORIES 32

- DIVIDERS 33
- HOLDERS 32
- SIDETABLE 32
- SPAREPARTS 34-35
- WASTEBASKET 32

## SOCKET WRENCH SETS AND TOOL SETS 6-19

**PAGE**

### SOCKET SETS 8-16

- 1/4" 8-12
- 3/8" 13-14
- 1/2" 15
- 3/4 16

### TOOL SETS 17-19, 83

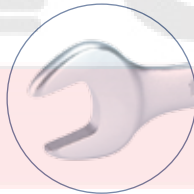

## WRENCHES 84-97

**PAGE**

- ADJUSTABLE 92
- COMBINATION 85-86
- DOUBLE SOCKET RATCHET 88
- FLARE NUT 90
- OFFSET 89
- OPEN END 87
- REVERSIBLE GEAR COMBINATION 87
- RING END 89
- SETS 85-92
- SWIVEL GEAR COMBINATION 91

## AIR TOOLS 148-161

**PAGE**

- ACCESSORIES 158-160
- DRILLS 157
- GRINDERS 154-155
- HAMMERS 156
- IMPACT WRENCHES 150-152
- NEEDLE SCALERS 157
- POLISHERS 156
- RATCHETS 153
- SANDERS 156

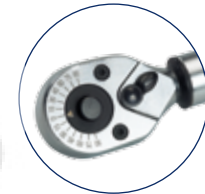

## TORQUE WRENCHES 93-99

**PAGE**

- ANGLE AND TORQUE ADAPTERS 97
- ANGLE METER 98
- BICYCLE TORQUE KITS 96
- BOX END INSERTS 98
- CLICK-TYPE TORQUE WRENCHES 94
- DIGITAL TORQUE MINI WRENCHES 95
- DIGITAL TORQUE WRENCHES 94-95
- DIGITAL TORQUE SCREWDRIVERS 97
- OPEN END INSERTS 98-99
- RATCHET INSERTS 99





# POLAR® TOOL INDEX



## PLIERS 100-109

PAGE

### PLIERS 100-108

- CIRCLIP 106
- COMBINATION 101
- DIAGONAL 101
- ELECTRONIC 102
- LOCKING 107-108
- NOSE 101
- SETS 102, 106
- WATER PUMP 102
- WIRE STRIPPER 101

### PLIERS, INSULATED 104-105

- CABLE CUTTERS 105
- COMBINATION 104
- DIAGONAL 104
- NOSE 104
- SETS 105
- WIRE STRIPPER 104

### MORE...

- ELECTRICIANS SCISSOR 108
- FILES 109
- METAL CUTTING SHEARS 108



## MISCELLANEOUS PRODUCTS 168-175

PAGE

- BENCH VISES 169
- CABLE TIES 174
- MAGNETIC PICK-UP TOOL 169
- KNIVES 170
- LEVELS 173
- SAWS (HAND- AND HACK SAW) 171
- TAPE RULES 172-173
- UNIVERSAL PULLER 169
- VERNIER CALIPER 172
- WORK LAMP (LED) 175



## SCREWDRIVERS AND BITS 110-131

PAGE

### BITS AND ACCESSORIES 124-131

- 1/4" BITS 124-129
- 1/4" ADAPTERS 130
- 5/16" BITS 130-131
- BITS SETS 126-129, 131
- SCREWDRIVER BIT SOCKETS 130-131

### L-SHAPED KEYS 121-123

- HEXAGON KEYS 121-122
- TORX® 122
- SETS 122-123

### SCREWDRIVERS 112-120

- DISPLAY SET 178
- FLEX 116
- GO-THROUGH 112-115
- HEX HEAD 116
- PHILLIPS® 112
- POZIDRIV® 113
- RATCHET SCREWDRIVER 119
- SETS 113-116
- SLOTTED 112
- TAMPER RESISTANT® 116
- TORX® 115

### SCREWDRIVERS, INSULATED 117-118

- PHILLIPS® 117
- POZIDRIV® 117
- SETS 118
- SLOTTED 117
- VOLTAGE TESTER 117

### SCREWDRIVERS, PRECISION 119-120

- PHILLIPS® 119
- SETS 120
- SLOTTED 119
- TAMPER RESISTANT® 119
- TORX® 119



## SOCKETS AND ACCESSORIES 132-147

PAGE

### 1/4" MANUAL 134-137

### 3/8" MANUAL 138-139

### 1/2" MANUAL 140-146

### 1/2" IMPACT 158-161

### 3/4" MANUAL 147



## STRIKING TOOLS 162-167

PAGE

- CHISELS 166-167
- HAMMERS 163-164
- PUNCHES 165-166
- SETS 165-167



## DISPLAYS & COLLECTION 176-181

PAGE

- DISPLAY STAND 176
- DISPLAYS FOR TOOL SETS 177
- POLAR COLLECTION 179-181
- SALES DISPLAYS 177-178

# POLAR TOOLS

## WE ARE PROUD TO PRESENT OUR **NEW POLAR® CATALOGUE.**

**POLAR TOOLS A/S** is a Scandinavian manufacturer and supplier of professional quality tools. The company was established in 2006 with focus on global sales, creating strong and individual solutions to our global customers within various sectors – from the Army to the Pharmaceutical Industry, Offshore to Airlines, from Denmark to all over the world.

We have one single definition; to produce, sell and supply quality tools. **POLAR®** is good and solid handtools, which are characterized by reliability and design. **POLAR®** handtools follow the strict demands for quality and utility, though **POLAR®** handtools are sold at competitive prices.

At **POLAR®** we focus on offering an assortment which matches the present marked demands and expectations to a serious supplier of handtools. For this reason, all **POLAR®** handtools are carefully selected, examined and tested by professional users at our test centers.

Experience the wide range of products from **POLAR®**, which counts for more than 1,600 quality tools and still more to come.





POLAR®



# POLARTOOLS.COM

Visit our up-to-date website for the latest product news and activities, and find all necessary technical information related to our products.

If you want to be sure not to miss important news, then sign up for our newsletter or join us on Facebook.

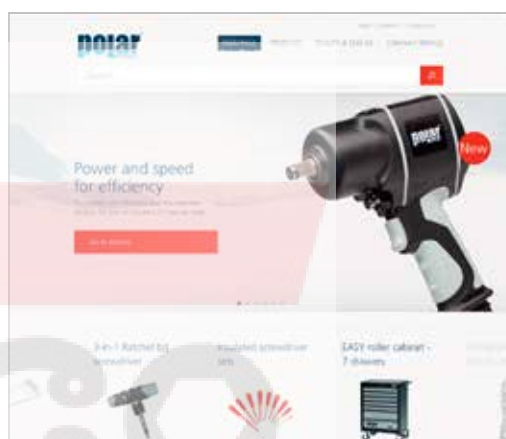

Products, News, Catalogues, Manuals and more.



Clearly sorted by range and size.



Product details, technical information and related products.

## POLAR® SOCKET WRENCH SETS AND TOOL SETS

# SOCKET WRENCH SETS &

*POLAR® offers a wide selection of different tool sets in sturdy water-resistant plastic cases and strong metal boxes.*

*Our plastic cases include a variety of features:*

- Metal hinges
- Lockable with padlock
- Rubber gasket for water resistance
- Durable construction

*Our metal boxes include following features:*

- ABS trays
- Firm handle
- Strong metal hinges
- 1.2 mm strong steel casing
- Durable construction



# TOOL SETS



# POLAR® SOCKET WRENCH SETS AND TOOL SETS

## SOCKET WRENCH SET

### 5090 HC 1/4" METRIC SOCKET WRENCH SET

ITEM NO. 5090-1423

- Socket wrench set supplied in compact plastic box with 6-point sockets from 4 to 13 mm, bits and accessories.
- The set is supplied with a reversible 72-teeth ratchet with locking system.
- 23 tools.

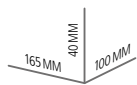

0,49 KG

5704196 014906

1

1/4"

1/4"

**CONTENT:**

QTY.	DESCRIPTION	SIZE
12	6-point sockets	5014 1/4" 4 - 4.5 - 5 - 5.5 - 6 - 7 - 8 - 9 - 10 - 11 - 12 - 13 mm
2	Bits for Phillips® screws	4514 1/4" PH 1 - 2
2	Bits for Pozidriv® screws	4514 1/4" PZ 1 - 2
4	Bits for Torx® screws	4514 1/4" TX T15 - T20 - T25 - T30
1	Screwdriver bit socket	4714 1/4" x 1/4"
1	Wobble extension	5214 1/4" EXW 100 mm
1	Ratchet, 72 teeth	5314 C 1/4"







**POLAR®**

## SOCKET WRENCH SETS AND TOOL SETS



### 5090 H 1/4" METRIC SOCKET WRENCH SET

ITEM NO. 5090-1418

- Socket wrench set in watertight plastic case with 6-point sockets from 4 to 14 mm and accessories.
- The set is supplied with a reversible 60-teeth ratchet with locking system.
- 18 tools.

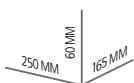

0,8 KG

5704196 000572

1

1/4"

18  
TOOLS



**CONTENT:**

QTY.	DESCRIPTION	SIZE
13	6-point sockets	5014 1/4" 4 - 4.5 - 5 - 5.5 - 6 - 7 - 8 - 9 - 10 - 11 - 12 - 13 - 14 mm
1	Ratchet, 60 teeth	5314 A 1/4"
2	Extensions	5214 1/4" EX 50 - 100 mm
1	Sliding T-handle	5414 1/4" TH
1	Universal joint	5814 1/4" U



# POLAR® SOCKET WRENCH SETS AND TOOL SETS

## 5090 HB 1/4" METRIC SOCKET WRENCH SET

ITEM NO. 5090-1441

- Socket wrench set in watertight plastic case with 6-point sockets from 4 to 14 mm, socket drivers and accessories.
- The set is supplied with a reversible 60-teeth ratchet with locking system.
- 41 tools.

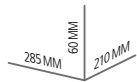

1,4 KG

5704196 000589

1

1/4"



**CONTENT:**

QTY.	DESCRIPTION	SIZE	QTY.	DESCRIPTION	SIZE
12	6-point sockets	5014 1/4" 4 - 5 - 5.5 - 6 - 7 - 8 - 9 - 10 - 11 - 12 - 13 - 14 mm	3	Socket drivers for Phillips® screws	5114 1/4" PH 1 - 2 - 3
1	Ratchet, 60 teeth	5314 A 1/4"	3	Socket drivers for Pozidriv® screws	5114 1/4" PZ 1 - 2 - 3
2	Extensions	5214 1/4" EX 50 - 100 mm	8	Socket drivers for Tamper Resistant® Torx® screws	5114 1/4" STX T8 - T10 - T15 - T20 - T25 - T27 - T30 - T40
1	Sliding T-handle	5414 1/4" TH	6	Socket drivers for hex head screws	5114 1/4" H 3 - 4 - 5 - 6 - 8 - 10 mm
1	Universal joint	5814 1/4" U			
1	Plastic handle driver	5514 1/4" HD			
3	Socket drivers for slotted head screws	5114 1/4" 4 - 5.5 - 7 mm			

**POLAR®**  
SOCKET WRENCH SETS AND TOOL SETS



**5090 HL 1/4" METRIC SOCKET WRENCH SET**

**ITEM NO. 5090-1459**

- Socket wrench set in watertight plastic case with short and long 6-point sockets from 4 to 13 mm, bits and accessories.
- The set is supplied with a reversible 60-teeth ratchet with locking system.
- 59 tools.

**59 TOOLS**

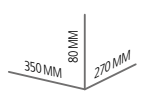

- 1,9 KG
- 5704196 000596
- 1
- 1/4"
- 1/4"



**CONTENT:**

QTY.	DESCRIPTION	SIZE	QTY.	DESCRIPTION	SIZE
11	6-point sockets	5014 1/4" 4 - 5 - 5.5 - 6 - 7 - 8 - 9 - 10 - 11 - 12 - 13 mm	1	Quick-Release screwdriver bit socket	4714 1/4" QR
10	Long 6-point sockets	5014 1/4" L 4 - 5 - 6 - 7 - 8 - 9 - 10 - 11 - 12 - 13 mm	5	Bits for slotted head screws	4514 1/4" 3.5 - 4.5 - 5.5 - 6.5 - 8 mm
1	Ratchet, 60 teeth	5314 A 1/4"	3	Bits for Phillips® screws	4514 1/4" PH 1 - 2 - 3
2	Extensions	5214 1/4" EX 50 - 100 mm	3	Bits for Pozidriv® screws	4514 1/4" PZ 1 - 2 - 3
1	Sliding T-handle	5414 1/4" TH	10	Bits for Tamper Resistant® Torx® screws	4514 1/4" STX T7 - T8 - T9 - T10 - T15 - T20 - T25 - T27 - T30 - T40
1	Universal joint	5814 1/4" U	7	Bits for hex head screws	4514 1/4" H 2 - 3 - 4 - 5 - 6 - 7 - 8 mm
1	Plastic handle driver	5514 1/4" HD	2	Bits for square head screws	4514 1/4" SQ 1 - 2
1	Screwdriver bit socket	4714 1/4" x 1/4"			

# POLAR® SOCKET WRENCH SETS AND TOOL SETS

## 5090 HIB 1/4" METRIC AND INCH SOCKET WRENCH SET

ITEM NO. 5090-1460

- Socket wrench set in watertight plastic case with 6-point sockets from 4 to 14 mm, 3/16" to 1/2", bits and accessories.
- The set is supplied with a reversible 60-teeth ratchet with locking system.
- 60 tools.

60  
TOOLS

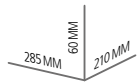

- 2,6 KG
- 5704196 000602
- 1
- 1/4"
- 1/4"



**CONTENT:**

QTY.	DESCRIPTION	SIZE	QTY.	DESCRIPTION	SIZE
12	6-point sockets	5014 1/4" 4 - 5 - 5.5 - 6 - 7 - 8 - 9 - 10 - 11 - 12 - 13 - 14 mm	1	Quick-Release screwdriver bit socket	4714 1/4" QR
9	6-point sockets	5014 1/4" 3/16 - 7/32 - 1/4 - 9/32 - 5/16 - 11/32 - 3/8 - 7/16 - 1/2"	5	Bits for slotted head screws	4514 1/4" 3.5 - 4.5 - 5.5 - 6.5 - 8 mm
1	Ratchet, 60 teeth	5314 A 1/4"	3	Bits for Phillips® screws	4514 1/4" PH 1 - 2 - 3
2	Extensions	5214 1/4" EX 50 - 100 mm	3	Bits for Pozidriv® screws	4514 1/4" PZ 1 - 2 - 3
1	Flexible extension	5214 1/4" F	10	Bits for Tamper Resistant® Torx® screws	4514 1/4" STX T7 - T8 - T9 - T10 - T15 - T20 - T25 - T27 - T30 - T40
1	Sliding T-handle	5414 1/4" TH	7	Bits for hex head screws	4514 1/4" H 2 - 3 - 4 - 5 - 6 - 7 - 8 mm
1	Universal joint	5814 1/4" U	2	Bits for square head screws	4514 1/4" SQ 1 - 2
1	Plastic handle driver	5514 1/4" HD			
1	Screwdriver bit socket	4714 1/4" x 1/4"			



5090 H **5090 3/8" METRIC SOCKET WRENCH SET**

ITEM NO. 5090-3812

- Socket wrench set in metal box with 6-point sockets from 7 to 19 mm and accessories.
- The set is supplied with a reversible 72-teeth ratchet with locking system.
- 12 tools.

**12 TOOLS**

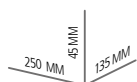

1,7 KG

5704196 018485

1

3/8"



CONTENT:

QTY.	DESCRIPTION	SIZE
9	6-point sockets	5038 3/8" 6 - 7 - 8 - 9 - 10 - 11 - 12 - 13 - 14 - 15 - 16 mm
1	Ratchet, 72 teeth	5338 3/8"
1	Extension	5238 3/8" EX 150 mm
1	Sliding T-handle	5438 3/8" TH



# POLAR® SOCKET WRENCH SETS AND TOOL SETS

## 5090 HL 3/8" METRIC SOCKET WRENCH SET

ITEM NO. 5090-3836

- Socket wrench set in watertight plastic case with 6-point sockets from 6 to 22 mm, long sockets from 8 to 22 mm and accessories.
- The set is supplied with a reversible 72-teeth ratchet with locking system.
- 36 tools.

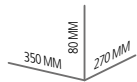

- 3,4 KG
- 5704196 000619
- 1
- 3/8"
- 3/8"



**CONTENT:**

QTY.	DESCRIPTION	SIZE
17	6-point sockets	5038 3/8" 6 - 7 - 8 - 9 - 10 - 11 - 12 - 13 - 14 - 15 - 16 - 17 - 18 - 19 - 20 - 21 - 22 mm
12	Long 6-point sockets	5038 3/8" L 8 - 9 - 10 - 11 - 12 - 13 - 14 - 15 - 17 - 19 - 20 - 22 mm
1	Ratchet, 72 teeth	5338 3/8"
1	Extension	5238 3/8" EX 150 mm
1	Sliding T-handle	5438 3/8" TH
1	Universal joint	5838 3/8" U
3	Spark plug sockets	5038 3/8" SP 16 - 18 - 21 mm

# POLAR® SOCKET WRENCH SETS AND TOOL SETS



## 5090 H 1/2" METRIC SOCKET WRENCH SET

ITEM NO. 5090-1223

- Socket wrench set in watertight plastic case with 6-point sockets from 10 to 32 mm and accessories.
- The set is supplied with a reversible 72-teeth ratchet with locking system.
- 23 tools.

23  
TOOLS

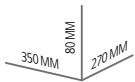

4,1 KG

5704196 000626

1

1/2"



**CONTENT:**

QTY.	DESCRIPTION	SIZE
18	6-point sockets	5012 1/2" 10 - 11 - 12 - 13 - 14 - 15 - 16 - 17 - 18 - 19 - 20 - 21 - 22 - 23 - 24 - 27 - 30 - 32 mm
1	Ratchet, 72-teeth	5312 1/2"
2	Extensions	5212 1/2" EX 125, 250 mm
1	Sliding T-handle	5412 1/2" TH
1	Universal joint	5812 1/2" U



# POLAR® SOCKET WRENCH SETS AND TOOL SETS

## 5090 H 3/4" METRIC SOCKET WRENCH SET

ITEM NO. 5090-3415

- Socket wrench set in plastic case with 6-point sockets from 22 to 50 mm and accessories.
- The set is supplied with a reversible 40-teeth ratchet.
- 14 tools.

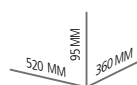

13 KG

5704196 000633

1

3/4"

14  
TOOLS



**CONTENT:**

QTY.	DESCRIPTION	SIZE
10	6-point sockets	5034 3/4" 22 - 24 - 27 - 30 - 32 - 36 - 38 - 41 - 46 - 50 mm
1	Ratchet, 40 teeth	5334 3/4"
2	Extensions	5234 3/4" EX 100 - 200 mm
1	Sliding T-handle	5434 3/4" TH







## POLAR® SOCKET WRENCH SETS AND TOOL SETS



### 5191 A 1/4" AND 3/8" METRIC TOOL SET

ITEM NO. 5191-1098

- Socket wrench set in watertight plastic case with short and long 6-point sockets, bits, combination wrenches, screwdrivers, adjustable wrench, pliers, hammer and accessories.
- The set is supplied with reversible ratchets with locking system.
- 98 tools.

98  
TOOLS

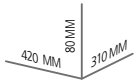

6,0 KG

5704196 000664

1

1/4" 3/8"

1/4"



#### CONTENT:

QTY.	DESCRIPTION	SIZE	QTY.	DESCRIPTION	SIZE
12	6-point sockets	5014 1/4" 4 - 4.5 - 5 - 5.5 - 6 - 7 - 8 - 9 - 10 - 11 - 12 - 13 mm	5	Bits for slotted head screws	4514 1/4" 3.5 - 4.5 - 5.5 - 6.5 - 8 mm
10	Long 6-point sockets	5014 1/4" L 4 - 5 - 6 - 7 - 8 - 9 - 10 - 11 - 12 - 13 mm	3	Bits for Phillips® screws	4514 1/4" PH 1 - 2 - 3
12	6-point sockets	5038 3/8" 10 - 11 - 12 - 13 - 14 - 15 - 16 - 17 - 18 - 19 - 20 - 22 mm	3	Bits for Pozidriv® screws	4514 1/4" PZ 1 - 2 - 3
2	Spark plug sockets	5038 3/8" SP 18 - 21 mm	10	Bits for Tamper Resistant® Torx® screws	4514 1/4" STX T7 - T8 - T9 - T10 - T15 - T20 - T25 - T27 - T30 - T40
1	Ratchet, 60 teeth	5314 A 1/4"	7	Bits for hex head screws	4514 1/4" H 2 - 3 - 4 - 5 - 6 - 7 - 8 mm
1	Ratchet, 72 teeth	5338 3/8"	2	Bits for square head screws	4514 1/4" SQ 1 - 2
2	Extensions	5214 1/4" EX 50 - 100 mm	1	Screwdriver for slotted head screws	4000 5,5 x 125 mm
2	Extensions	5238 3/8" EX 150 - 250 mm	1	Screwdriver for Phillips® screws	4010 PH 2
1	Sliding T-handle	5414 1/4" TH	1	Screwdriver for Pozidriv® screws	4020 PZ 2
1	Universal joint	5814 1/4" U	13	Combination wrenches	2000 7 - 8 - 9 - 10 - 11 - 12 - 13 - 14 - 15 - 16 - 17 - 18 - 19 mm
1	Universal joint	5838 3/8" U	1	Adjustable wrench	2605 150 mm / 8"
1	Plastic handle driver	5514 1/4" HD	1	Combination plier	3001 180 mm
1	Screwdriver bit socket	4714 1/4" x 1/4"	1	Waterpump plier	3020 250 mm
1	Quick-Release screwdriver bit socket	4714 1/4" QR	1	Engineers hammer	8030 300 g

## POLAR® SOCKET WRENCH SETS AND TOOL SETS

### 5191 B 1/4" AND 1/2" METRIC TOOL SET

ITEM NO. 5191-0098

- Socket wrench set in watertight plastic case with short and long 6-point sockets, bits, combination wrenches, double swivel end socket wrenches and accessories.
- The set is supplied with reversible ratchets with locking system.
- 98 tools.

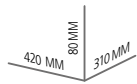

7,2 KG

5704196 000640

1

1/4" 1/2"

1/4" 5/16"



#### CONTENT:

QTY.	DESCRIPTION	SIZE	QTY.	DESCRIPTION	SIZE
12	6-point sockets	5014 1/4" 4 - 4.5 - 5 - 5.5 - 6 - 7 - 8 - 9 - 10 - 11 - 12 - 13 mm	1	Quick-Release screwdriver bit socket	4714 1/4" QR
10	Long 6-point sockets	5014 1/4" L 4 - 5 - 6 - 7 - 8 - 9 - 10 - 11 - 12 - 13 mm	1	Socket adaptor	4714 1/4" SQ 25 mm
13	6-point sockets	5012 1/2" 10 - 11 - 12 - 13 - 14 - 15 - 17 - 19 - 22 - 24 - 27 - 30 - 32 mm	5	Bits for slotted head screws	4514 1/4" 3.5 - 4.5 - 5.5 - 6.5 - 8 mm
1	Ratchet, 60 teeth	5314 A 1/4"	3	Bits for Phillips® screws	4514 1/4" PH 1 - 2 - 3
1	Ratchet, 72 teeth	5312 1/2"	3	Bits for Pozidriv® screws	4514 1/4" PZ 1 - 2 - 3
2	Extensions	5214 1/4" EX 50 - 100 mm	10	Bits for Tamper Resistant® Torx® screws	4514 1/4" STX T7 - T8 - T9 - T10 - T15 - T20 - T25 - T27 - T30 - T40
2	Extensions	5212 1/2" EX 125 - 250 mm	4	Bits for Torx® screws	4516 5/16" TX T40 - T45 - T50 - T55
1	Flexible handle	5912 1/2" FH 410 mm	7	Bits for hex head screws	4514 1/4" H 2 - 3 - 4 - 5 - 6 - 7 - 8 mm
1	Sliding T-handle	5414 1/4" TH	2	Bits for square head screws	4514 1/4" SQ 1 - 2
1	Sliding T-handle	5412 1/2" TH	6	Combination wrenches	2000 8 - 10 - 12 - 13 - 14 - 17 mm
1	Universal joint	5814 1/4" U	4	Double swivel end socket wrenches	2400 8x9 - 10x11 - 12x13 - 14x15 mm
1	Universal joint	5812 1/2" U	3	Hexagon keys	4100 1.5 - 2 - 2.5 mm
1	Plastic handle driver	5514 1/4" HD			
1	Screwdriver bit socket	4714 1/4" x 1/4"			
1	Screwdriver bit socket	4712 1/2" x 5/16"			



# POLAR® SOCKET WRENCH SETS AND TOOL SETS



## 5191 C 1/4", 3/8" AND 1/2" METRIC TOOLSET

ITEM NO. 5191-0147

- Socket wrench set in watertight plastic case with short and long 6-point sockets, bits, combination wrenches, adjustable wrench, double swivel end socket wrenches, pliers, hammer and accessories.
- Supplied with reversible ratchets with locking system.
- 147 tools.

147  
TOOLS

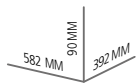

12,6 KG

5704196 000657

1

1/4" 3/8" 1/2"

1/4" 5/16"



### CONTENT:

QTY.	DESCRIPTION	SIZE	QTY.	DESCRIPTION	SIZE
13	6-point sockets	5014 1/4" 4 - 4.5 - 5 - 5.5 - 6 - 7 - 8 - 9 - 10 - 11 - 12 - 13 - 14 mm	1	Screwdriver bit socket	4714 1/4" x 1/4"
10	Long 6-point sockets	5014 1/4" L4 - 5 - 6 - 7 - 8 - 9 - 10 - 11 - 12 - 13 mm	1	Screwdriver bit socket	4712 1/2" x 5/16"
6	6-point sockets	5038 3/8" 10 - 13 - 16 - 17 - 18 - 19 mm	1	Socket adaptor	4714 1/4" SQ 25 mm
13	6-point sockets	5012 1/2" 10 - 11 - 12 - 13 - 14 - 15 - 17 - 19 - 22 - 24 - 27 - 30 - 32 mm	1	Socket adaptor	4716 3/8" SQ 25 mm
4	Sockets for Torx® screws	5014 1/4" NTX E4 - E5 - E6 - E7	1	Quick-Release screwdriver bit socket	4714 1/4" QR
7	Sockets for Torx® screws	5038 3/8" NTX E8 - E10 - E11 - E12 - E14 - E16 - E18	5	Bits for slotted head screws	4514 1/4" 3.5 - 4.5 - 5.5 - 6.5 - 8 mm
3	Spark plug sockets	5038 3/8" SP 16 - 18 - 21 mm	2	Bits for slotted head screws	4516 5/16" 10 - 12 mm
3	Long thinwalled 6-point sockets	6012 1/2" LT 17 - 19 - 21 mm	3	Bits for Phillips® screws	4514 1/4" PH 1 - 2 - 3
1	Ratchet, 60 teeth	5314 A 1/4"	1	Bits for Phillips® screws	4516 5/16" PH 4
1	Ratchet, 72 teeth	5338 3/8"	3	Bits for Pozidriv® screws	4514 1/4" PZ 1 - 2 - 3
1	Ratchet, 72 teeth	5312 1/2"	1	Bits for Pozidriv® screws	4516 5/16" PZ 4
2	Extensions	5214 1/4" EX 50 - 100 mm	10	Bits for Tamper Resistant® Torx® screws	4514 1/4" STX T7 - T8 - T9 - T10 - T15 - T20 - T25 - T27 - T30 - T40
1	Extension	5238 3/8" EX 125 mm	4	Bits for Torx® screws	4516 5/16" TX T40 - T45 - T50 - T55
2	Extensions	5212 1/2" EX 125 - 250 mm	7	Bits for hex head screws	4514 1/4" H 2 - 3 - 4 - 5 - 6 - 7 - 8 mm
1	Flexible extension	5214 1/4" F	2	Bits for hex head screws	4516 5/16" H 10 - 12 mm
1	Flexible handle	5912 1/2" FH 410 mm	2	Bits for square head screws	4514 1/4" SQ 1 - 2
1	Sliding T-handle	5414 1/4" TH	13	Combination wrenches	2000 7 - 8 - 9 - 10 - 11 - 12 - 13 - 14 - 15 - 16 - 17 - 18 - 19 mm
1	Sliding T-handle	5438 3/8" TH	4	Double swivel end socket wrenches	2400 8x9 - 10x11 - 12x13 - 14x15 mm
1	Sliding T-handle	5412 1/2" TH	3	Metric hexagon keys	4100 1.5 - 2 - 2.5 mm
1	Universal joint	5814 1/4" U	1	Adjustable wrench	2605 250 mm / 10"
1	Universal joint	5838 3/8" U	1	Combination plier	3001 180 mm
1	Universal joint	5812 1/2" U	1	Waterpump plier	3020 250 mm
1	Plastic handle driver	5514 1/4" HD	1	Engineers hammer	8030 300 g
1	Adaptor	5738 3/8" A			
1	Adaptor	5712 1/2" A			

**polar**  
handtools

**polar**  
handtools

## POLAR® ROLLER CABINETS, ASSORTMENTS AND STORAGE

# ROLLER CABINETS

*POLAR® Roller cabinets have been developed and built to exceed the highest standards. The construction of our tool storage units are performed without compromise, to ensure the strength and durability you need.*

*All our Roller cabinets includes the following standard features:*

- Quick lock system
- Centralized locking
- Drawer with steel handles
- Double wall construction
- Reinforced corner gussets
- 1.2 mm strong sheet steel casing
- Worktop in chemical resistant hard PVC material
- Oil-proof rubber mats in all drawers
- Large oil-proof rubber casters

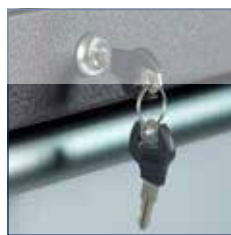



**polar**  
handtools

**polar**  
handtools

## POLAR® ROLLER CABINETS, ASSORTMENTS AND STORAGE

### ROLLER CABINETS

# EASY

*POLAR® EASY is our most popular roller cabinet, which gives you reliability and space, to store your tools and equipment. A large program of side cabinets and accessories makes this roller cabinet very versatile.*

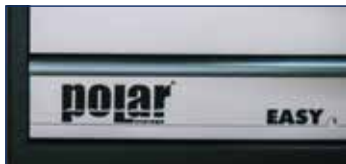
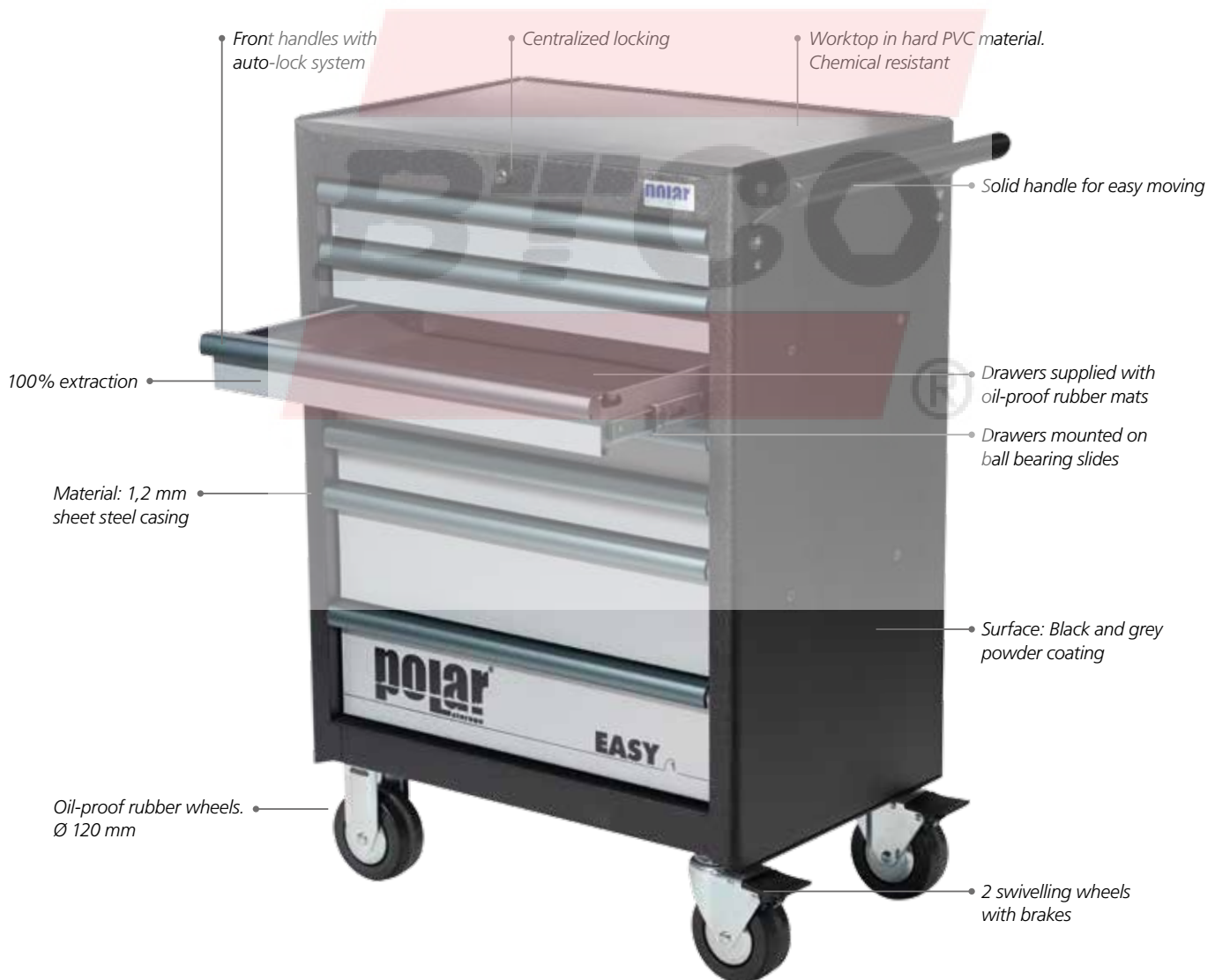

# POLAR® ROLLER CABINETS, ASSORTMENTS AND STORAGE



### TROLLEY DIMENSIONS

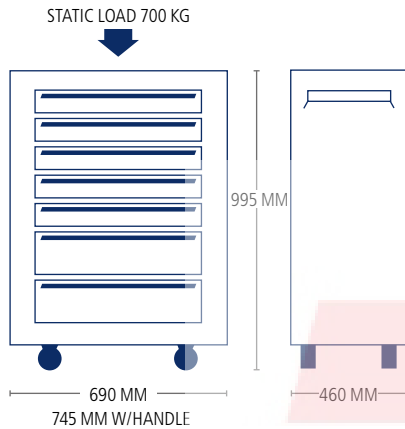

### DRAWER DIMENSIONS

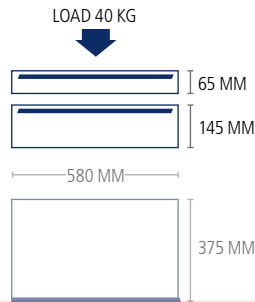

### EASY TOOLSETS

163 tools - page 38  
350 tools - page 39  
425 tools - page 40

### EASY ACCESSORIES

Page 32-33

### EASY SPAREPARTS

Page 34-35



## 1000 7D EASY ROLLER CABINET (EMPTY)

ITEM NO. 1000-0007



- Empty trolley with 7 drawers.
- 5 drawers: H 65 x W 580 x D 375 mm
- 2 drawers: H 145 x W 580 x D 375 mm
- Heavy-duty construction: 700 kg static load.
- Drawer loading capacity: 40 kg

## 1090 EASY ROLLER CABINET WITH TWO CABINETS AND TOP CHEST (EMPTY)

ITEM NO. 1090-0004



- Supplied with sidecabinets models 1010 A and B (page 31) and tool chest model 1005 4D (page 30).

**polar**  
handtools

**polar**  
handtools

## POLAR® ROLLER CABINETS, ASSORTMENTS AND STORAGE

# X-LARGE

POLAR® X-LARGE gives you 50 % more storage capacity for your tools and equipment. The large worktop makes it a good workstation, whenever mobility is needed. The roller cabinet is available with 7 and 8 drawers.





# POLAR® ROLLER CABINETS, ASSORTMENTS AND STORAGE



## TROLLEY DIMENSIONS



## DRAWER DIMENSIONS

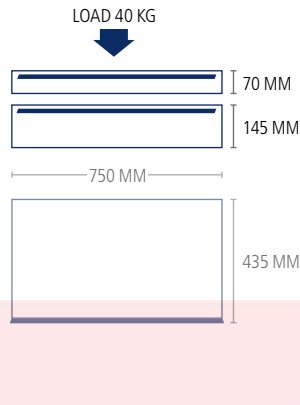

## X-LARGE TOOLSETS

350 tools - page 42-43  
447 tools - page 44-45  
470 tools - page 46-47  
473 tools - page 48-49

## X-LARGE ACCESSORIES

Page 32-33

## X-LARGE SPAREPARTS

Page 34-35

### 1000 7D X-LARGE ROLLER CABINET (EMPTY)

ITEM NO. 1000-1007

84,5 KG 5704196 013510



### 1000 8D X-LARGE ROLLER CABINET (EMPTY)

ITEM NO. 1000-1008

85 KG 5704196 015668

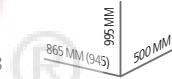

- Empty trolley with 7 drawers.
- 5 drawers: H 70 x W 750 x D 435 mm.
- 2 drawers: H 145 x W 750 x D 435 mm
- Heavy-duty construction: 750 kg static load.
- Drawer loading capacity: 40 kg

- Empty trolley with 8 drawers.
- 7 drawers: H 70 x W 750 x D 435 mm.
- 1 drawer: H 145 x W 750 x D 435 mm
- Heavy-duty construction: 750 kg static load.
- Drawer loading capacity: 40 kg

**polar**  
handtools

**polar**  
handtools

## POLAR® ROLLER CABINETS, ASSORTMENTS AND STORAGE

# CARGO

*POLAR® CARGO is our largest roller cabinet and preferable when storage space and mobility is the key word. Adding side cabinets and accessories, will make this roller cabinet very versatile and a true workstation.*



**POLAR®**  
ROLLER CABINETS, ASSORTMENTS AND STORAGE



**TROLLEY DIMENSIONS**

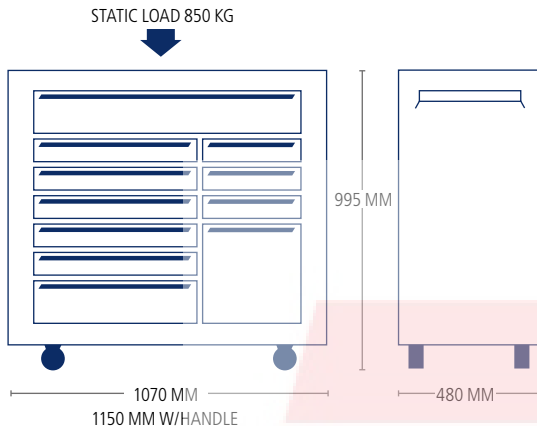

**DRAWER DIMENSIONS**

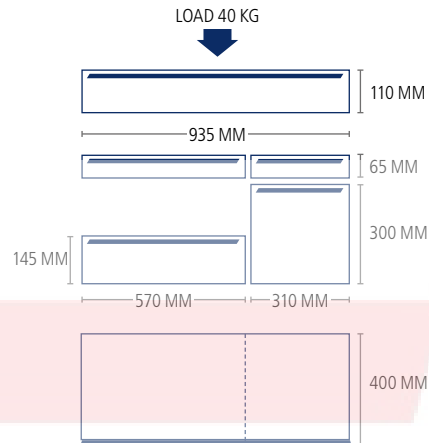

**CARGO TOOLSETS**

163 tools - page 73  
350 tools - page 67

**CARGO ACCESSORIES**

Page 32-33

**CARGO SPAREPARTS**

Page 34-35

**1000 11D CARGO ROLLER CABINET (EMPTY)**

ITEM NO. 1000-2011

127 KG 5704196 013527

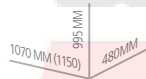

- Empty trolley with 11 drawers mounted on ball bearing slides.
- 1 drawer: H 110 x W 935 x D 400 mm
- 5 drawers: H 65 x W 570 x D 400 mm
- 1 drawer: H 145 x W 570 x D 400 mm
- 3 drawers: H 65 x W 310 x D 400 mm
- 1 drawer: H 300 x W 310 x D 400 mm
- Heavy-duty construction: 850 kg static load.
- Drawer loading capacity: 40 kg

## POLAR® ROLLER CABINETS, ASSORTMENTS AND STORAGE

# MINI

POLAR® MINI trolley is our small and compact trolley, but with same technical features as the standard trolleys. It has been designed to fit underneath our workbench, taking up a minimum of floor space.



### TROLLEY DIMENSIONS

STATIC LOAD 200 KG

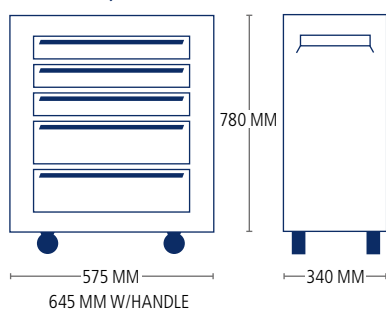

### DRAWER DIMENSIONS

LOAD 30 KG

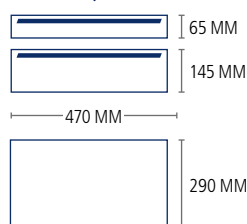

### MINI TOOLSETS

66 tools - page 83

### MINI ACCESSORIES

Page 32-33

### MINI SPAREPARTS

Page 34-35



## 1000 5D MINI CABINET (EMPTY)

ITEM NO. 1000-3005

 35 KG

 5704196 016863

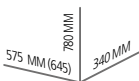

- Empty trolley with 5 drawers.
- 3 drawers: H 65 x W 470 x D 290 mm.  
2 drawers: H 145 x W 470 x D 290 mm
- Construction: 200 kg static load.
- Drawer loading capacity: 30 kg





*The MINI roller cabinet can be stored under the workbench.*

## POLAR® ROLLER CABINETS, ASSORTMENTS AND STORAGE

### DRAWER CHESTS

#### 1050 2D TOOL BOX

ITEM NO. 1050-0002

 5704196 016887 **HxWxD** 240 x 495 x 225 mm  7,7 KG  1



- 2 drawers mounted on ball bearing slides.
- All drawers are supplied with oil-proof rubber mats.
- Centralized locking. Handles on both sides.
- Drawer loading capacity: 15 kg
- Upper compartment: H 55 x W 440 x D 210 mm
- 2 drawers: H 75 x W 465 x D 195 mm
- Surface: Black and grey powder coating.
- Material: 1,2 mm sheet steel casing.

#### 1005 4D DRAWER CHEST

ITEM NO. 1005-0004



 5704196 015675 **HxWxD** 490 x 660 x 405 mm  33 KG  1



- 4 drawers mounted on ball bearing slides.
- Front handles with auto-lock system.
- Supplied with tool tray
- All drawers are supplied with oil-proof rubber mats.
- Centralized locking. Handles on both sides.
- Possible to combine with roller cabinets EASY and X-LARGE.
- Drawer loading capacity: 30 kg
- Upper compartment: H 70 x W 650 x D 390 mm
- 4 drawers: H 75 x W 580 x D 375 mm
- 1 tray: H 43 x W 440 x D 180 mm
- Surface: Black and grey powder coating.
- Material: 1,2 mm sheet steel casing.

#### 1005 3D DRAWER CHEST

ITEM NO. 1005-0003

 5704196 016870 **HxWxD** 340 x 690 x 460 mm  28 KG  1



- 3 drawers mounted on ball bearing slides.
- Front handles with auto-lock system.
- All drawers are supplied with oil-proof rubber mats.
- Centralized locking. Handles on both sides.
- Possible to combine with roller cabinets EASY and X-LARGE.
- Drawer loading capacity: 30 kg
- 3 drawers: H 65 x W 580 x D 375 mm
- Surface: Black and grey powder coating.
- Material: 1,2 mm sheet steel casing.



# POLAR® ROLLER CABINETS, ASSORTMENTS AND STORAGE



## SIDECABINETS

### 1010 A SIDECABINET WITH 2 SHELVES

ITEM NO. 1010-0001

5704196 013534 HxWxD 860 x 380 x 460 mm 20 KG 1

- Possible to combine with roller cabinets EASY, X-LARGE and CARGO.
- Shelf loading capacity: 30 kg
- 2 shelves: W 350 x D 420 mm
- Surface: Black and grey powder coating.
- Material: 1,2 mm sheet steel casing.



### 1010 C SIDECABINET WITH PANEL

ITEM NO. 1010-0003

5704196 013558 HxWxD 860 x 310 x 460 mm 28 KG 1

- Possible to combine with roller cabinets EASY, X-LARGE and CARGO.
- 1 panel with 30 hooks: H 630 x W 415 mm
- 1 upper compartment: H 65 x W 190 x D 410 mm
- Surface: Black and grey powder coating.
- Material: 1,2 mm sheet steel casing.



### 1010 B SIDECABINET WITH DRAWERS

ITEM NO. 1010-0002

5704196 013541 HxWxD 860 x 380 x 460 mm 41 KG 1

- 7 drawers mounted on ball bearing slides.
- All drawers are supplied with oil-proof rubber mats.
- Centralized locking.
- Possible to combine with roller cabinets EASY, X-LARGE and CARGO.
- Drawer loading capacity: 40 kg
- 5 drawers: H 70 x W 265 x D 400 mm
- 2 drawers: H 150 x W 265 x D 400 mm
- Surface: Black and grey powder coating.
- Material: 1,2 mm sheet steel casing.



#### SUITABLE FOR

EASY - page 22  
X-LARGE - page 24  
CARGO - page 26



## POLAR® ROLLER CABINETS, ASSORTMENTS AND STORAGE

### ACCESSORIES

#### 1011 A HOLDER FOR SPRAYCANS

ITEM NO. 1011-0001

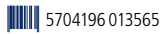

5704196 013565

HxWxD 90 x 90 x 430 mm

1,25 KG



- Possible to mount on roller cabinets EASY, X-LARGE and CARGO.
- Surface: Black and grey powder coating.
- Material: 1,2 mm sheet steel casing.

#### 1011 C PAPER HOLDER

ITEM NO. 1011-0003

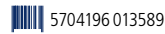

5704196 013589

HxWxD 100 x 375 x 220 mm

1,25 KG



- Possible to mount on roller cabinets EASY, X-LARGE and CARGO.
- Paperroll: Max. width 365 mm, max. Ø 380 mm
- Surface: Black and grey powder coating.
- Material: 2 mm sheet steel casing.

#### 1011 B SIDETABLE

ITEM NO. 1011-0002

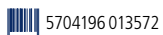

5704196 013572

HxWxD 178 x 405 x 434 mm

4 KG



- Possible to mount on roller cabinets EASY, X-LARGE and CARGO.
- Workarea: 434 x 405 mm
- Surface: Black powder coating.
- Material: 1,2 mm sheet steel casing.

#### 1011 D WASTEBASKET

ITEM NO. 1011-0004



5704196 016511

HxWxD 450 x 365 x 260 mm

1,4 KG



- 25-liter plastic bin (including bracket).
- Can be used together with roller cabinets MINI, EASY, X-LARGE and CARGO.





# POLAR® ROLLER CABINETS, ASSORTMENTS AND STORAGE

## 1011 FB EXTERNAL DIVIDERS

▪ To be placed in the front and back of the drawer.



ITEM NO.	5704196+	USABLE FOR TROLLEYS	L MM	H MM	KG	
1011-0100	016757	EASY	552	50	0,264	1
1011-0120	016771	X-LARGE	578	50	0,343	1

## 1011 SQ HORIZONTAL DIVIDERS



ITEM NO.	5704196+	TYPE	L MM	H MM	KG	
1011-0140	016825	0	80	50	0,048	1
1011-0141	016818	1	117	50	0,071	1
1011-0142	016801	2	155	50	0,098	1
1011-0143	016795	3	193	50	0,119	1

## 1011 ST VERTICAL DIVIDERS

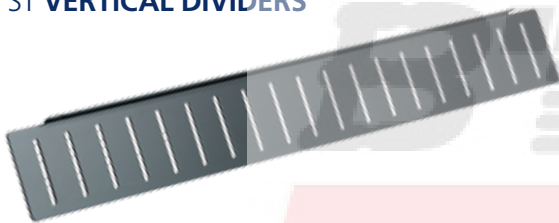

ITEM NO.	5704196+	USABLE FOR TROLLEYS	L MM	H MM	KG	
1011-0105	016764	EASY	372	50	0,232	1
1011-0125	016788	X-LARGE	434	50	0,273	1

## 1011 S/17 SET OF 17 DIVIDERS

ITEM NO. 1011-0150

5704196 016856

1,3 KG

1

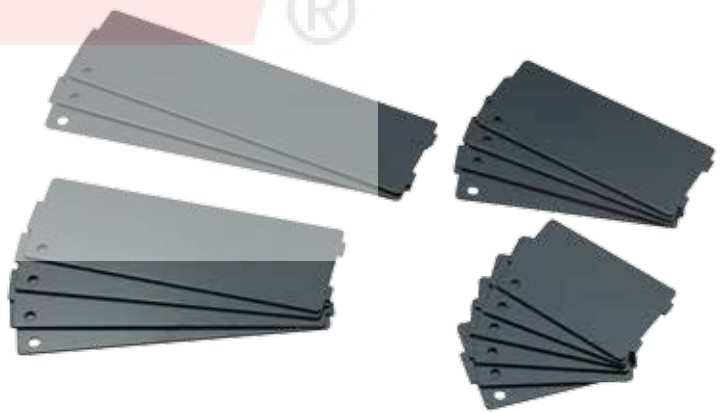

## 1011 S/6 SET OF DIVIDERS

▪ Set with two external dividers and four vertical dividers.



▪ The set contains 6 dividers type 0 - 4 dividers type 1 - 4 dividers type 2 and 3 dividers type 3.

ITEM NO.	5704196+	USABLE FOR TROLLEYS	KG	
1011-0110	016832	EASY	1,4	1
1011-0130	016849	X-LARGE	1,8	1



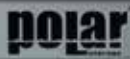

# POLAR® ROLLER CABINETS, ASSORTMENTS AND STORAGE

## SPAREPARTS

### LOCK WITH 2 KEYS FOR ROLLER CABINETS

■ For all POLAR® STORAGE products.



ITEM NO. 5704196+  
P1000-0000-00 016528

G 1  
67

### TOPPLATE

■ For EASY, X-LARGE and CARGO.



ITEM NO.	5704196+	TYPE	HxWxD MM	G	
P1000-0000-05	027104	EASY	13 x 675 x 450	5500	1
P1000-1000-05	027111	X-LARGE	13 x 855 x 490	7750	1
P1000-2000-05	027128	CARGO	13 x 1055 x 470	9400	1

### MASTER KEY

■ For all POLAR® STORAGE products.



ITEM NO. 5704196+  
P1000-0000-01 027135

G 1  
6

### WHEEL WITH BRAKE

■ Wheel for EASY and X-LARGE with brake.



ITEM NO.	5704196+	WHEEL Ø	G	
P1000-0000-08	027142	120 mm	1579	1

### KEY FOR ROLLER CABINET

■ For all POLAR® STORAGE products.  
■ On purchase - enlight existing key number.



ITEM NO. 5704196+  
P1000-0000-02 027159

G 1  
6

### WHEEL

■ Wheel for EASY and X-LARGE.



ITEM NO.	5704196+	WHEEL Ø	G	
P1000-0000-09	027166	120 mm	1129	1



# POLAR® ROLLER CABINETS, ASSORTMENTS AND STORAGE



## MATS FOR ROLLER CABINETS

■ For EASY and X-LARGE.



ITEM NO.	5704196+	TYPE	QTY. PCS.	G	
P1000-0000-10	027173	EASY	7	196	1
P1000-1000-10	027180	X-LARGE	7	250	1
P1000-1000-11	027197	X-LARGE	8	350	1

## DRAWER - CARGO



ITEM NO.	5704196+	HxWxD	G	
P1000-2000-20	019444	120 x 935 x 400 mm	7350	1
P1000-2000-21	019437	75 x 570 x 400 mm	3932	1
P1000-2000-22	019420	154 x 570 x 400 mm	5500	1
P1000-2000-23	019413	75 x 310 x 400 mm	2516	1
P1000-2000-24	019406	312 x 310 x 400 mm	5600	1

## DRAWER - EASY

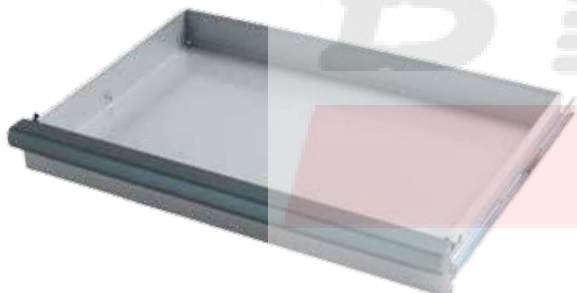

ITEM NO.	5704196+	HxWxD	G	
P1000-0000-20	019499	75 x 580 x 375 mm	3333	1
P1000-0000-21	019482	154 x 580 x 375 mm	4276	1
P1000-0000-22	019475	312 x 580 x 375 mm	6600	1

## DRAWER - MINI

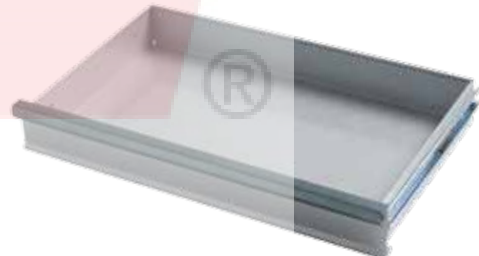

ITEM NO.	5704196+	HxWxD	G	
P1000-3000-20	019390	75 x 480 x 295 mm	1994	1
P1000-3000-21	019383	154 x 480 x 295 mm	2706	1

## DRAWER - X-LARGE



ITEM NO.	5704196+	HxWxD	G	
P1000-1000-20	019468	70 x 750 x 435 mm	5250	1
P1000-1000-21	019451	154 x 750 x 435 mm	6850	1

## HANDLE - DRAWER CHESTS

■ For model 1005.



ITEM NO.	5704196+	G	
P1005-0004-01	027203	223	1

## POLAR® ROLLER CABINETS, ASSORTMENTS AND STORAGE

# TOOL ASSORTMENTS

*POLAR® Modular tool tray system ensures your tools to be in the right place. The POLAR® inlays are made of durable material and protected by a plastic tray, in order to withstand intense use. All tools are carefully arranged and always securely held in the same place.*





# POLAR® ROLLER CABINETS, ASSORTMENTS AND STORAGE

## MODULAR TOOL TRAY SYSTEM

The POLAR® Modular tool tray system consists of two different sizes. The 'Triple' type takes up the same space as three 'Single' type trays, as shown in below drawing, giving multiple combinations for our range of trolleys and tool chests.

## TOOL ASSORTMENTS

From page 50 to 66



**SINGLE TRAY**  
370 X 140 MM

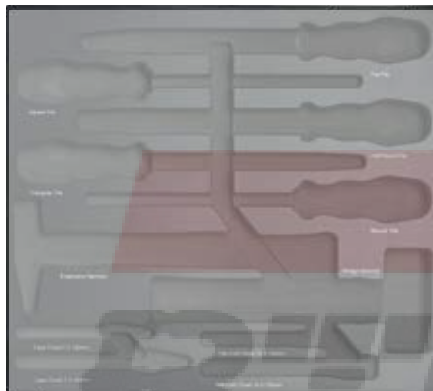

**TRIPLE TRAY**  
370 X 415 MM

## EXAMPLES

### TOOL TRAYS IN EASY DRAWERS AND DRAWER CHESTS (3D + 4D)

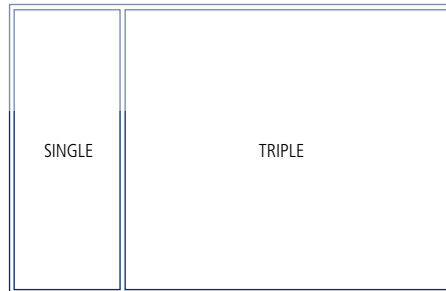
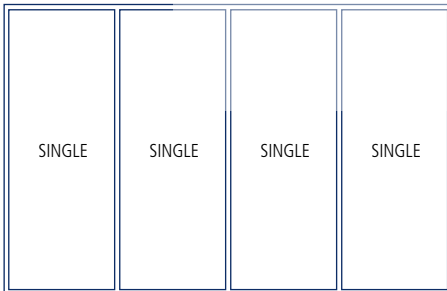

### TOOL TRAYS IN X-LARGE DRAWERS

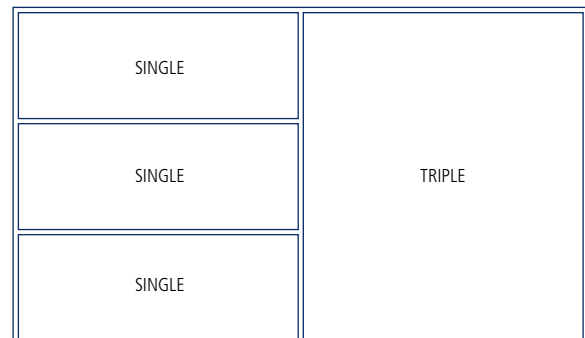
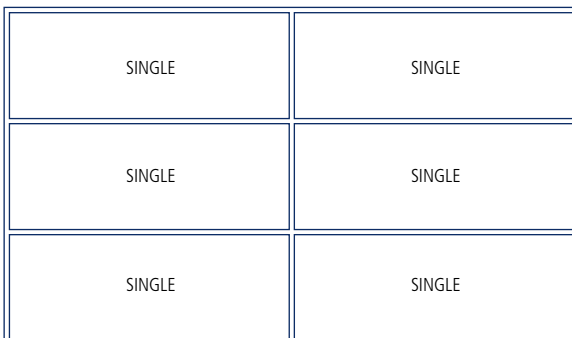



# POLAR® ROLLER CABINETS, ASSORTMENTS AND STORAGE

## ROLLER CABINETS WITH TOOL ASSORTMENTS

### 1091 B7E ROLLER CABINET WITH TOOL ASSORTMENT

ITEM NO. 1091-0163

- EASY roller cabinet with tool set type 1875 S5.
- 7 drawers.
- 163 tools.

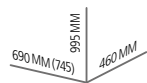

90 KG

5704196 020396



163  
TOOLS

7  
DRAWERS

#### CONTENT:



- 1800 Combination wrench set 8 - 19 mm
- 1801 Combination wrench set 20 - 24 mm
- 1814 1/4" Socket wrench set 4 - 14 mm
- 1819 1/2" Socket wrench set 10 - 32 mm

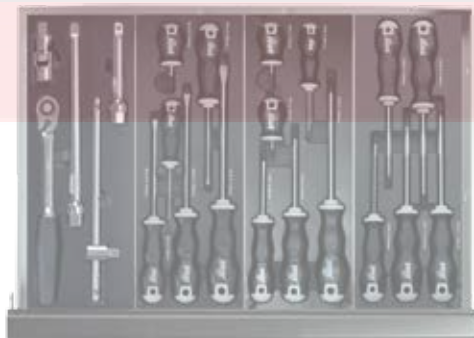

- 1827 1/2" Ratchet and accessories
- 1829 B Screwdriver set for slotted head screws
- 1830 C Screwdriver set, PH
- 1831 A Screwdriver set, TX



- 1834 Metric and Torx® hexagon key set
- 1835 Plier set with combination-, cutting- and long nose plier
- 1836 Plier set with waterpump- and locking pliers
- 1845 Measuring and cutting toolset



**POLAR®**  
ROLLER CABINETS, ASSORTMENTS AND STORAGE



**1091 A7E ROLLER CABINET WITH TOOL ASSORTMENT**

ITEM NO. 1091-0350

- EASY roller cabinet with tool set type 1875 S1.
- 7 drawers.
- 350 tools.

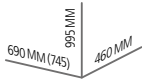

106 KG

5704196 020402



**CONTENT:**



- 1800 Combination wrench set 8 - 19 mm
- 1801 Combination wrench set 20 - 24 mm
- 1807 Reversible ratchet combination wrench set 8 - 19 mm
- 1812 Double swivel end socket wrench set 8 - 19 mm



- 1813 1/4" Socket wrench set 4 - 14 mm
- 1815 1/4" Long sockets and socket drivers
- 1817 3/8" Socket wrench set 6 - 22 mm
- 1819 1/2" Socket wrench set 10 - 32 mm



- 1820 1/2" Long sockets 10 - 24 mm
- 1825 1/2" Long socket drivers for hex head screws 5 - 19 mm
- 1826 1/2" Long socket drivers for Torx® screws T10 - T50
- 1827 1/2" Ratchet and accessories



- 1829 B Screwdriver set for slotted head screws
- 1830 C Screwdriver set, PH
- 1831 A Screwdriver set, TX
- 1834 Metric and Torx® hexagon key set



- 1835 Plier set with combination-, cutting- and long nose pliers
- 1836 Plier set with waterpump- and locking plier
- 1837 Adjustable wrenches 6" - 8" - 10"
- 1843 Bits set



- 1839 Hammers, chisels and files set
- 1845 Measuring and cutting tool set

**polar**  
handtools

**polar**  
handtools

## POLAR® ROLLER CABINETS, ASSORTMENTS AND STORAGE

**CONTENT:**



- 1800 Combination wrench set 8 - 19 mm
- 1801 Combination wrench set 20 - 24 mm
- 1807 Reversible ratchet combination wrench set 8 - 19 mm
- 1812 Double swivel end socket wrench set 8 - 19 mm



- 1813 1/4" Socket wrench set 4 - 14 mm
- 1815 1/4" Long sockets and socket drivers
- 1817 3/8" Socket wrench set 6 - 22 mm
- 1819 1/2" Socket wrench set 10 - 32 mm



- 1820 1/2" Long sockets 10 - 24 mm
- 1824 1/2" Socket drivers for slot-head, Phillips®, Pozidriv® and hexagonal screws
- 1825 1/2" Long socket drivers for hex head screws 5 - 19 mm
- 1826 1/2" Long socket drivers for Torx® screws T10 - T50



- 1827 1/2" Ratchet and accessories
- 1829 Screwdriver set
- 1830 Screwdriver set for Phillips® and Pozidriv® screws
- 1831 Screwdriver set, TX



- 1834 Metric and Torx® hexagon key set
- 1835 Plier set with combination-, cutting- and long nose pliers
- 1836 Plier set with waterpump- and locking pliers
- 1837 Adjustable wrenches 6" - 8" - 10"



- 1839 Hammers, chisels and files set
- 1841 Plier set for circlips 19 - 60 mm



- 1842 1/2" Impact socket set
- 1840 Impact tool set
- 1848 Bits set
- 1844 Measuring and cutting tool set



- 1845 Measuring and cutting tool set
- 1847 Impact driver bit set
- 1848 Screwdriver set, hex
- 1849 Screwdriver set

### 1091 B10E ROLLER CABINET WITH TOOL ASSORTMENT

ITEM NO. 1091-0425

- EASY roller cabinet and top drawer chest with tool set type 1875 S2.
- 10 drawers.
- 425 tools.

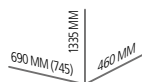

145 KG

5704196 020372

425  
TOOLS

10  
DRAWERS







**polar**  
handtools

**polar**  
handtools

## POLAR® ROLLER CABINETS, ASSORTMENTS AND STORAGE

### 1091 A7XL ROLLER CABINET WITH TOOL ASSORTMENT

ITEM NO. 1091-1350

- X-LARGE roller cabinet with tool set type 1875 S1.
- 7 drawers.
- 350 tools.

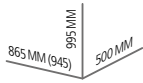

128 KG

5704196 021799

350  
TOOLS

7  
DRAWERS



### 1091 A8XL ROLLER CABINET WITH TOOL ASSORTMENT

ITEM NO. 1091-2350

- X-LARGE roller cabinet with tool set type 1875 S1.
- 8 drawers.
- 350 tools.

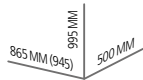

128,5 KG

5704196 021805

350  
TOOLS

8  
DRAWERS



# POLAR® ROLLER CABINETS, ASSORTMENTS AND STORAGE

CONTENT: (BOTH A7XL AND A8XL)



- 1800 Combination wrench set 8 - 19 mm
- 1801 Combination wrench set 20 - 24 mm
- 1807 Reversible ratchet combination wrench set 8 - 19 mm

- 1812 Double swivel end socket wrench set 8 - 19 mm
- 1813 1/4" Socket wrench set 4 - 14 mm
- 1815 1/4" Long sockets and socket drivers

- 1817 3/8" Socket wrench set 6 - 22 mm
- 1819 1/2" Socket wrench set 10 - 32 mm
- 1820 1/2" Long sockets 10 - 24 mm

- 1825 1/2" Long socket drivers for hex head screws 5 - 19 mm
- 1826 1/2" Long socket drivers for Torx® screws T10 - T50
- 1827 1/2" Ratchet and accessories

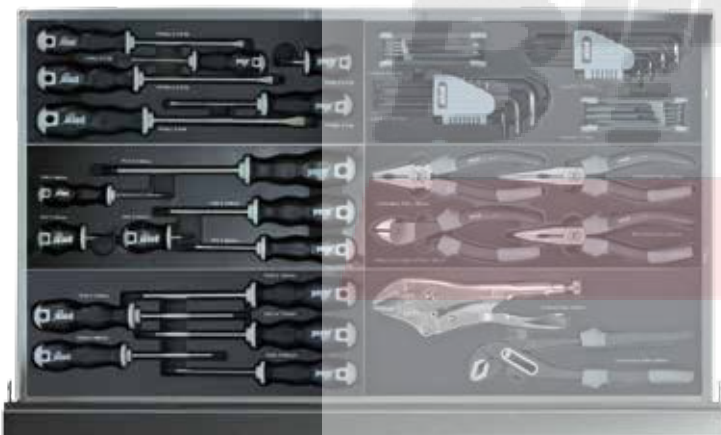

- 1829 B Screwdriver set for slotted head screws
- 1830 C Screwdriver set, PH
- 1831 A Screwdriver set, TX

- 1834 Metric and Torx® hexagon key set
- 1835 Plier set with combination-, cutting- and long nose pliers
- 1836 Plier set with waterpump- and locking plier

- 1837 Adjustable wrenches 6" - 8" - 10"
- 1843 Bits set
- 1845 Measuring and cutting tools set

- 1839 Hammers, chisels and files set





### 1091 B8XL ROLLER CABINET WITH TOOL ASSORTMENT

ITEM NO. 1091-1447

- X-LARGE roller cabinet with tool set type 1875 S7.
- 8 drawers.
- 447 tools.

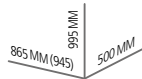

138 KG

5704196 020389

# POLAR® ROLLER CABINETS, ASSORTMENTS AND STORAGE

**CONTENT:**



1800 Combination wrench set 8 - 19 mm  
1801 Combination wrench set 20 - 24 mm  
1805 A Metric double open end wrench set

1805 B Metric double open end wrench set  
1807 Reversible ratchet combination wrench set 8 - 19 mm  
1812 Double swivel end socket wrench set 8 - 19 mm



1813 1/4" Socket wrench set 4 - 14 mm  
1815 1/4" Long sockets and socket drivers  
1817 3/8" Socket wrench set 6 - 22 mm

1819 1/2" Socket wrench set 10 - 32 mm  
1820 1/2" Long sockets 10 - 24 mm  
1824 1/2" Socket drivers for slot-head, Phillips®, Pozidriv® and hexagonal screws

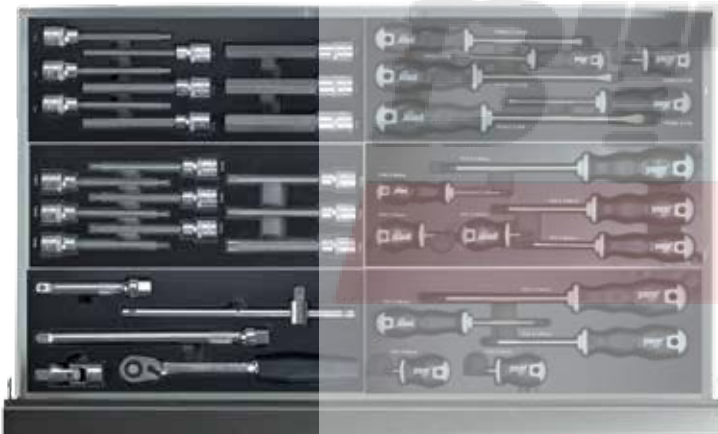

1825 1/2" Long socket drivers for hex head screws 5 - 19 mm  
1826 1/2" Long socket drivers for Torx® screws T10 - T50  
1827 1/2" Ratchet and accessories

1829 B Screwdriver set for slotted head screws  
1830 C Screwdriver set, PH  
1830 B Screwdriver set, PZ

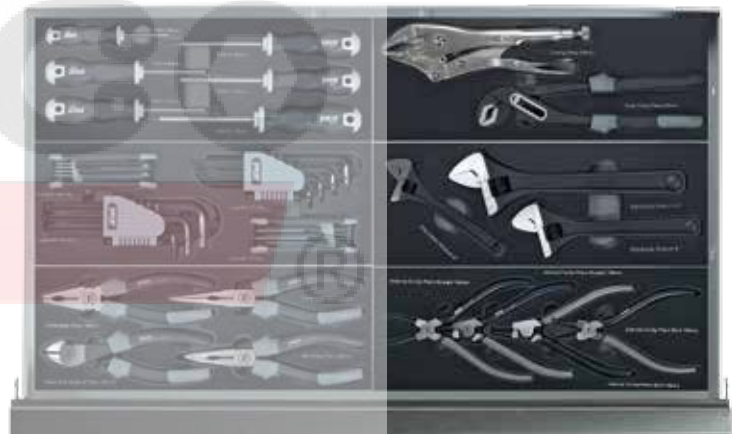

1831 A Screwdriver set, TX  
1834 Metric and Torx® hexagon key set  
1835 Plier set with combination-, cutting- and long nose pliers

1836 Plier set with waterpump- and locking pliers  
1837 Adjustable wrenches 6" - 8" - 10"  
1841 Plier set for circlips 19 - 60 mm



1842 1/2" Impact socket set  
1843 Bits set  
1844 Measuring and cutting tool set

1845 Measuring and cutting tool set  
1848 Screwdriver set, hex  
1849 Screwdriver set



1846 Impact accessories  
1847 Impact driver bit set  
1840 Impact tool set

1839 Hammers, chisels and files set

**polar**  
handtools

**polar**  
handtools

# POLAR® ROLLER CABINETS, ASSORTMENTS AND STORAGE

## 1091 C7XL ROLLER CABINET WITH TOOL ASSORTMENT

ITEM NO. 1091-0470

- X-LARGE roller cabinet with tool set type 1875 S3 (p. 70-71).
- 7 drawers.
- 470 tools.

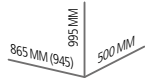

136 KG

5704196 015644



## 1091 C8XL ROLLER CABINET WITH TOOL ASSORTMENT

ITEM NO. 1091-1470

- X-LARGE roller cabinet with tool set type 1875 S3 (p. 70-71).
- 8 drawers.
- 470 tools.

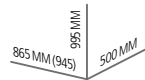

137 KG

5704196 015774



CONTENT: (FOR SPECIFIC CONTENT SEE PAGE 70-71)



Screwdriver set



Pliers, circlips pliers and cutting tools

# POLAR® ROLLER CABINETS, ASSORTMENTS AND STORAGE

CONTENT: (FOR SPECIFIC CONTENT SEE PAGE 70-71)



1/2" Socket wrench set  
1/2" Torque wrench



Combination and double swivel end socket wrenches  
Reversible gear combination wrenches

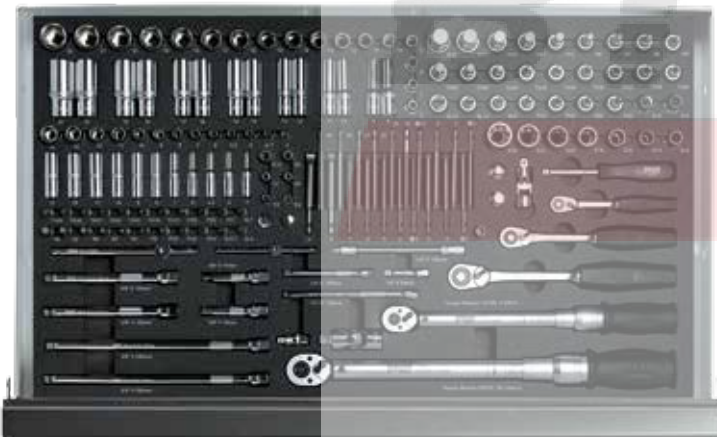

1/4" - 3/8" - 1/2" Metric sockets, socket drivers and accessories  
1/4" - 3/8" Torque wrenches



Bits, hammers and impact tools



Impact driver, adjustable wrenches, hexagonal keys, files and measuring tools

**polar**  
handtools

**polar**  
handtools

# POLAR® ROLLER CABINETS, ASSORTMENTS AND STORAGE

## 1091 D7XL ROLLER CABINET WITH TOOL ASSORTMENT

ITEM NO. 1091-0473

- X-LARGE roller cabinet with tool set type 1875 S6 (p. 74-75).
- 7 drawers.
- 473 tools.

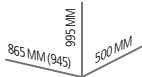

137 KG

5704196018676

## 1091 D8XL ROLLER CABINET WITH TOOL ASSORTMENT

ITEM NO. 1091-1473

- X-LARGE roller cabinet with tool set type 1875 S6 (p. 74-75).
- 8 drawers.
- 473 tools.

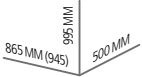

138 KG

5704196 018669



CONTENT: (FOR SPECIFIC CONTENT SEE PAGE 74-75)



Screwdriver set



Pliers, circlips pliers and cutting tools



# POLAR® ROLLER CABINETS, ASSORTMENTS AND STORAGE



CONTENT: (FOR SPECIFIC CONTENT SEE PAGE 74-75)



1/2" Socket wrench set  
1/2" Torque wrench



Combination wrenches, double end ring wrenches and double open end wrenches  
Reversible gear combination wrenches

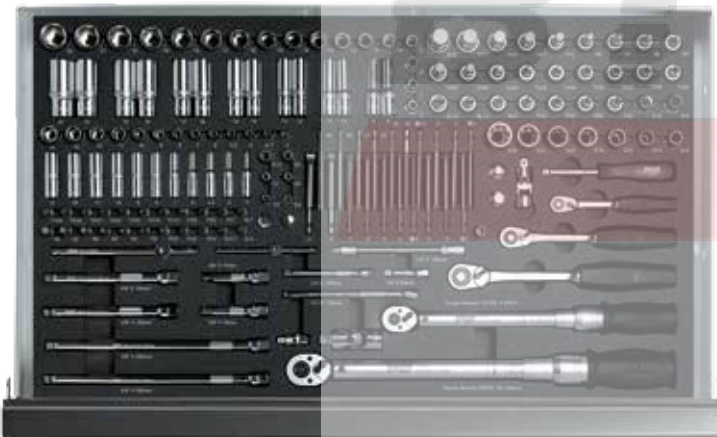

1/4" - 3/8" - 1/2" Metric sockets, socket drivers and accessories  
1/4" - 3/8" Torque wrenches



Bits, hammers and impact tools



Impact driver, adjustable wrenches, hexagonal keys, files and measuring tools

# POLAR® ROLLER CABINETS, ASSORTMENTS AND STORAGE

## TOOL ASSORTMENTS

### 1800 METRIC COMBINATION WRENCH SET

ITEM NO. 1800-0012

5704196 014135 **WxDxH** 370 x 140 x 40 **1,2 KG** **1**

- Set with combination wrenches from 8 to 19 mm supplied in plastbox with re-inforced EVA foam. 12 tools.



**12 TOOLS**

**CONTENT:**

QTY.	DESCRIPTION	SIZE
12	Combination wrenches	2000 8 - 9 - 10 - 11 - 12 - 13 - 14 - 15 - 16 - 17 - 18 - 19 mm

### ITEM NO. 1800-1012 1800 EMPTY PLASTBOX WITH EVA FOAM

5704196 014340 **WxDxH** 370 x 140 x 40 **0,3 KG**

### 1801 METRIC COMBINATION WRENCH SET

ITEM NO. 1801-0005

5704196 014142 **WxDxH** 370 x 140 x 40 **1,3 KG** **1**

- Set with combination wrenches from 20 to 24 mm supplied in plastbox with re-inforced EVA foam. 5 tools.



**5 TOOLS**

**CONTENT:**

QTY.	DESCRIPTION	SIZE
5	Combination wrenches	2000 20 - 21 - 22 - 23 - 24 mm

### ITEM NO. 1801-1005 1801 EMPTY PLASTBOX WITH EVA FOAM

5704196 014333 **WxDxH** 370 x 140 x 40 **0,3 KG**

### 1802 METRIC COMBINATION WRENCH SET

ITEM NO. 1802-0026

5704196 014159 **WxDxH** 415 x 370 x 40 **5,9 KG** **1**

- Set with combination wrenches from 6 to 32 mm supplied in plastbox with re-inforced EVA foam. 26 tools.



**26 TOOLS**

**CONTENT:**

QTY.	DESCRIPTION	SIZE
26	Combination wrenches	2000 6 - 7 - 8 - 9 - 10 - 11 - 12 - 13 - 14 - 15 - 16 - 17 - 18 - 19 - 20 - 21 - 22 - 23 - 24 - 25 - 26 - 27 - 28 - 29 - 30 - 32 mm

### ITEM NO. 1802-1026 1802 EMPTY PLASTBOX WITH EVA FOAM

5704196 014326 **WxDxH** 415 x 370 x 40 **0,8 KG**



# POLAR® ROLLER CABINETS, ASSORTMENTS AND STORAGE



## 1804 INCH COMBINATION WRENCH SET

ITEM NO. 1804-0016

5704196 014173 **WxDxH** 415 x 370 x 40 **3,9 KG** **1**

- Set with combination wrenches from 1/4" to 1-1/4" supplied in plastbox with re-inforced EVA foam. 16 tools.

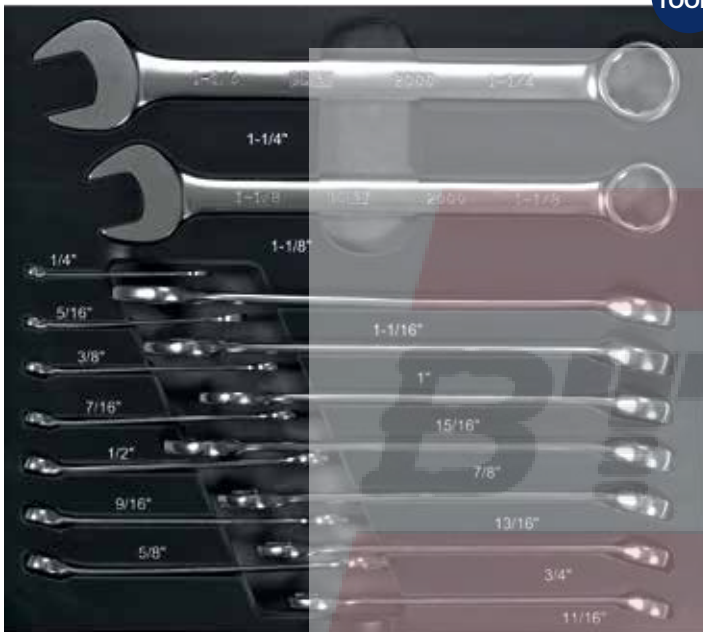

**16 TOOLS**

**CONTENT:**

QTY.	DESCRIPTION	SIZE
16	Combination wrenches	2000 1/4 - 5/16 - 3/8 - 7/16 - 1/2 - 9/16 - 5/8 - 11/16 - 3/4 - 13/16 - 7/8 - 15/16 - 1 - 1-1/16 - 1-1/8 - 1-1/4"

## ITEM NO. 1804-1016 1804 EMPTY PLASTBOX WITH EVA FOAM

5704196 014302 **WxDxH** 370 x 415 x 40 **0,8 KG**



## 1805 A METRIC DOUBLE OPEN END WRENCH SET

ITEM NO. 1805-0009

5704196 018188 **WxDxH** 370 x 140 x 40 **1,2 KG** **1**

- Set with double open end wrenches from 6 to 23 mm supplied in plastbox with re-inforced EVA foam. 9 tools.



**9 TOOLS**

**CONTENT:**

QTY.	DESCRIPTION	SIZE
9	Double open end wrenches	2010 6x7 - 8x9 - 10x11 - 12x13 - 14x15 - 16x17 - 18x19 - 20x22 - 21x23 mm

## ITEM NO. 1805-1009 1805 A EMPTY PLASTBOX WITH EVA FOAM

5704196 018195 **WxDxH** 370 x 140 x 40 **0,3 KG**

## 1805 B METRIC DOUBLE OPEN END WRENCH SET

ITEM NO. 1805-0003

5704196 018201 **WxDxH** 370 x 140 x 40 **1,35 KG** **1**

- Set with double open end wrenches from 24 to 32 mm supplied in plastbox with re-inforced EVA foam. 3 tools.



**3 TOOLS**

**CONTENT:**

QTY.	DESCRIPTION	SIZE
3	Double open end wrenches	2010 24x27 - 25x28 - 30x32 mm

## ITEM NO. 1805-1003 1805 B EMPTY PLASTBOX WITH EVA FOAM

5704196 018218 **WxDxH** 370 x 140 x 40 **0,3 KG**

# POLAR® ROLLER CABINETS, ASSORTMENTS AND STORAGE

## 1807 REVERSIBLE GEAR COMBINATION WRENCH SET

ITEM NO. 1807-0012

5704196 014104 **WxDxH** 370 x 140 x 40 **1,7 KG** **1**

- Set with reversible gear combination wrenches from 8 to 19 mm supplied in plastbox with re-inforced EVA foam. 12 tools.



**12 TOOLS**

**CONTENT:**

QTY.	DESCRIPTION	SIZE
12	Reversible gear combination wrenches	2005 8 - 9 - 10 - 11 - 12 - 13 - 14 - 15 - 16 - 17 - 18 - 19 mm

## 1809 METRIC OFFSET COMBINATION WRENCH SET

ITEM NO. 1809-0018

5704196 014203 **WxDxH** 415 x 370 x 40 **4,2 KG** **1**

- Set with offset combination wrenches from 8 to 32 mm supplied in plastbox with re-inforced EVA foam. 18 tools.



**18 TOOLS**

**CONTENT:**

QTY.	DESCRIPTION	SIZE
18	Offset combination wrenches	2100 8 - 9 - 10 - 11 - 12 - 13 - 14 - 15 - 16 - 17 - 18 - 19 21 - 22 - 24 - 27 - 30 - 32 mm

## 1807 EMPTY PLASTBOX WITH EVA FOAM

ITEM NO. 1807-1012

5704196 014357 **WxDxH** 370 x 140 x 40 **0,3 KG**

## 1808 SWIVEL GEAR COMBINATION WRENCH SET

ITEM NO. 1808-0012

5704196 014111 **WxDxH** 370 x 140 x 40 **1,9 KG** **1**

- Set with swivel gear combination wrenches from 8 to 19 mm supplied in plastbox with re-inforced EVA foam. 12 tools.



**12 TOOLS**

**CONTENT:**

QTY.	DESCRIPTION	SIZE
12	Swivel gear combination wrenches	2405 8 - 9 - 10 - 11 - 12 - 13 - 14 - 15 - 16 - 17 - 18 - 19 mm

## 1808 EMPTY PLASTBOX WITH EVA FOAM

ITEM NO. 1808-1012

5704196 014364 **WxDxH** 370 x 140 x 40 **0,3 KG**

## 1809 EMPTY PLASTBOX WITH EVA FOAM

ITEM NO. 1809-1018

5704196 014272 **WxDxH** 415 x 370 x 40 **0,8 KG**



# POLAR® ROLLER CABINETS, ASSORTMENTS AND STORAGE



## 1810 A METRIC DOUBLE END OFFSET RING WRENCH SET

ITEM NO. 1810-0005

5704196 018430 **WxDxH** 370 x 140 x 40 **Weight** 0,7 KG **Quantity** 1

- Set with double end offset ring wrenches from 6 to 15 mm supplied in plastbox with re-inforced EVA foam. 5 tools.



5 TOOLS

CONTENT:

QTY.	DESCRIPTION	SIZE
5	Double end offset ring wrenches	2110 6x7 - 8x9 - 10x11 - 12x13 - 14x15 mm

## 1811 METRIC FLARE NUT WRENCH SET

ITEM NO. 1811-0007

5704196 017228 **WxDxH** 370 x 140 x 40 **Weight** 1,3 KG **Quantity** 1

- Set with flare nut wrenches from 8 to 27 mm supplied in plastbox with re-inforced EVA foam. 7 tools.



7 TOOLS

CONTENT:

QTY.	DESCRIPTION	SIZE
7	Flare nut wrenches	2200 8x10 - 9x11 - 11x13 - 12x14 - 17x19 - 19x22 - 24x27 mm

## ITEM NO. 1810-1005 1810 A EMPTY PLASTBOX WITH EVA FOAM

5704196 018447 **WxDxH** 370 x 140 x 40 **Weight** 0,3 KG

## ITEM NO. 1811-1007 1811 EMPTY PLASTBOX WITH EVA FOAM

5704196 017235 **WxDxH** 370 x 140 x 40 **Weight** 0,3 KG

## 1810 B METRIC DOUBLE END OFFSET RING WRENCH SET

ITEM NO. 1810-0003

5704196 018454 **WxDxH** 370 x 140 x 40 **Weight** 1,0 KG **Quantity** 1

- Set with double end offset ring wrenches from 16 to 22 mm supplied in plastbox with re-inforced EVA foam. 3 tools.



3 TOOLS

CONTENT:

QTY.	DESCRIPTION	SIZE
3	Double end offset ring wrenches	2110 16x17 - 18x19 - 20x22 mm

## 1812 METRIC DOUBLE SWIVEL END SOCKET WRENCH SET

ITEM NO. 1812-0006

5704196 014234 **WxDxH** 370 x 140 x 40 **Weight** 1,6 KG **Quantity** 1

- Set with double swivel end socket wrenches from 8 to 19 mm supplied in plastbox with re-inforced EVA foam. 6 tools.



6 TOOLS

CONTENT:

QTY.	DESCRIPTION	SIZE
6	Double swivel end socket wrenches	2400 8x9 - 10x11 - 12x13 - 14x15 - 16x17 - 18x19 mm

## ITEM NO. 1810-1003 1810 B EMPTY PLASTBOX WITH EVA FOAM

5704196 018461 **WxDxH** 370 x 140 x 40 **Weight** 0,3 KG

## ITEM NO. 1812-1006 1812 EMPTY PLASTBOX WITH EVA FOAM

5704196 026794 **WxDxH** 370 x 140 x 40 **Weight** 0,3 KG

# POLAR® ROLLER CABINETS, ASSORTMENTS AND STORAGE

## 1813 1/4" METRIC SOCKET WRENCH SET

ITEM NO. 1813-0017

5704196014371 **WxDxH** 370 x 140 x 40 **0,8 KG** **1**

- Set with 6-point sockets from 4 to 14 mm and accessories supplied in plastbox with re-inforced EVA foam. The set is supplied with a reversible 60 teeth ratchet. 17 tools.

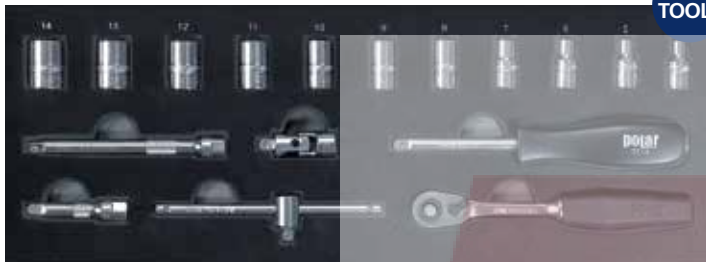

**17 TOOLS**

**CONTENT:**

QTY.	DESCRIPTION	SIZE
11	6-point sockets	5014 1/4" 4 - 5 - 6 - 7 - 8 - 9 - 10 - 11 - 12 - 13 - 14 mm
1	Ratchet, 60 teeth	5314 A 1/4"
1	Plastic handle driver	5514 1/4" HD
2	Extensions	5214 1/4" EX 50 - 100 mm
1	Sliding T-handle	5414 1/4" TH
1	Universal joint	5814 1/4" U

## 1814 1/4" METRIC SOCKET WRENCH SET

ITEM NO. 1814-0063

5704196014418 **WxDxH** 370 x 140 x 40 **1,4 KG** **1**

- Set with short 6-point sockets from 4 to 14 mm and long 6-point sockets from 4 to 13 mm, bits and accessories, supplied in plastbox with re-inforced EVA foam. The set is supplied with a reversible 60-teeth ratchet. 63 tools.



**63 TOOLS**

**CONTENT:**

QTY.	DESCRIPTION	SIZE
11	6-point sockets	5014 1/4" 4 - 5 - 6 - 7 - 8 - 9 - 10 - 11 - 12 - 13 - 14 mm
10	Long 6-point sockets	5014 1/4" L 4 - 5 - 6 - 7 - 8 - 9 - 10 - 11 - 12 - 13 mm
4	Sockets for Torx® screws	5014 1/4" NTX 4 - 5 - 6 - 7
1	Ratchet, 60 teeth	5314 A 1/4"
2	Extensions	5214 1/4" EX 50 - 100 mm
1	Sliding T-handle	5414 1/4" TH
1	Universal joint	5814 1/4" U
1	Plastic handle driver	5514 1/4" HD
1	Screwdriver bit socket	4714 1/4" x 1/4"
1	Bits set, 31 tools	4590 A 1/4"

ITEM NO. 1813-1017 **1813 EMPTY PLASTBOX WITH EVA FOAM**

5704196014388 **WxDxH** 370 x 140 x 40 **0,3 KG**

ITEM NO. 1814-1063 **1814 EMPTY PLASTBOX WITH EVA FOAM**

5704196014425 **WxDxH** 370 x 140 x 40 **0,3 KG**





## POLAR® ROLLER CABINETS, ASSORTMENTS AND STORAGE

### 1815 1/4" SOCKET WRENCH SET

ITEM NO. 1815-0038

5704196 014395 **WxDxH** 370 x 140 x 40 **0,9 KG** **1**

- Set with long 6-point sockets from 4 to 13 mm, NTX sockets for Torx® screws and socket drivers, supplied in plastbox with re-inforced EVA foam. 38 tools.



**38 TOOLS**

CONTENT:

QTY.	DESCRIPTION	SIZE
10	Long 6-point sockets	5014 1/4" 4 - 5 - 6 - 7 - 8 - 9 - 10 - 11 - 12 - 13 - 14 mm
6	Sockets for Torx® screws	5014 1/4" NTX E4 - E5 - E6 - E7 - E8 - E10
3	Socket drivers for slotted head screws	5114 1/4" 4 - 5.5 - 7 mm
3	Socket drivers for Phillips® screws	5114 1/4" PH 1 - 2 - 3
3	Socket drivers for Pozidriv® screws	5114 1/4" PZ 1 - 2 - 3
6	Socket drivers for hex head screws	5114 1/4" H 3 - 4 - 5 - 6 - 7 - 8 mm
7	Socket drivers for Tamper Resistant® Torx® screws	5114 1/4" STX T10 - T15 - T20 - T25 - T27 - T30 - T40

### 1817 3/8" METRIC SOCKET WRENCH SET

ITEM NO. 1817-0022

5704196 014432 **WxDxH** 370 x 140 x 40 **1,5 KG** **1**

- Set with 6-point sockets from 6 to 22 mm and accessories supplied in plastbox with re-inforced EVA foam. The set is supplied with a reversible 72 teeth ratchet. 22 tools.



**22 TOOLS**

CONTENT:

QTY.	DESCRIPTION	SIZE
17	6-point sockets	5038 3/8" 6 - 7 - 8 - 9 - 10 - 11 - 12 - 13 - 14 - 15 - 16 - 17 - 18 - 19 - 20 - 21 - 22 mm
1	Ratchet, 72 teeth	5338 3/8"
2	Extensions	5238 3/8" EX 75 - 150 mm
1	Sliding T-handle	5438 3/8" TH
1	Universal joint	5838 3/8" U

### ITEM NO. 1815-1038 1815 EMPTY PLASTBOX WITH EVA FOAM

5704196 014401 **WxDxH** 370 x 140 x 40 **0,3 KG**

### ITEM NO. 1817-1022 1817 EMPTY PLASTBOX WITH EVA FOAM

5704196 014449 **WxDxH** 370 x 140 x 40 **0,3 KG**

### 1816 1/4" AND 3/8" INCH SOCKET WRENCH SET

ITEM NO. 1816-0027

5704196 014456 **WxDxH** 370 x 140 x 40 **1,0 KG** **1**

- Set with 6-point sockets from 5/32" to 7/8" and adaptors supplied in plastbox with re-inforced EVA foam. 27 tools.



**27 TOOLS**

CONTENT:

QTY.	DESCRIPTION	SIZE
11	6-point sockets	5014 1/4" 5/32 - 3/16 - 7/32 - 1/4 - 9/32 - 5/16 - 11/32 - 3/8 - 13/32 - 7/16 - 1/2"
12	6-point sockets	5038 3/8" 1/4 - 5/16 - 3/8 - 7/16 - 1/2 - 9/16 - 19/32 - 5/8 - 11/16 - 3/4 - 13/16 - 7/8"
1	Adaptor	5614 1/4" A
1	Adaptor	5638 3/8" A
1	Adaptor	5738 3/8" A
1	Adaptor	5712 1/2" A

### 1818 3/8" METRIC SOCKET WRENCH SET

ITEM NO. 1818-0014

5704196 014470 **WxDxH** 370 x 140 x 40 **1,4 KG** **1**

- Set with long 6-point sockets from 8 to 22 mm supplied in plastbox with re-inforced EVA foam. 14 tools.



**14 TOOLS**

CONTENT:

QTY.	DESCRIPTION	SIZE
14	Long 6-point sockets	5038 3/8" L 8 - 9 - 10 - 11 - 12 - 13 - 14 - 15 - 16 - 17 - 18 - 19 - 20 - 21 - 22 mm

### ITEM NO. 1818-1014 1818 EMPTY PLASTBOX WITH EVA FOAM

5704196 014487 **WxDxH** 370 x 140 x 40 **0,3 KG**

### ITEM NO. 1816-1027 1816 EMPTY PLASTBOX WITH EVA FOAM

5704196 014463 **WxDxH** 370 x 140 x 40 **0,3 KG**  
Tel: (+974) 443 54 298  
www.boltsandtools.com

# POLAR® ROLLER CABINETS, ASSORTMENTS AND STORAGE

## 1819 1/2" METRIC SOCKET WRENCH SET

ITEM NO. 1819-0018

5704196 014494 **WxDxH** 370 x 140 x 40 **1,8 KG** **1**

- Set with 6-point sockets from 10 to 32 mm supplied in plastbox with re-inforced EVA foam. 18 tools



**18 TOOLS**

CONTENT:

QTY.	DESCRIPTION	SIZE
18	6-point sockets	5012 1/2" 10 - 11 - 12 - 13 - 14 - 15 - 16 - 17 - 18 - 19 - 20 - 21 - 22 - 23 - 24 - 27 - 30 - 32 mm

## 1821 1/2" METRIC SOCKET WRENCH SET

ITEM NO. 1821-0018

5704196 014531 **WxDxH** 370 x 140 x 40 **1,8 KG** **1**

- Set with 12-point sockets from 10 to 32 mm supplied in plastbox with re-inforced EVA foam. 18 tools



**18 TOOLS**

CONTENT:

QTY.	DESCRIPTION	SIZE
18	12-point sockets	5012 1/2" B 10 - 11 - 12 - 13 - 14 - 15 - 16 - 17 - 18 - 19 - 20 - 21 - 22 - 23 - 24 - 27 - 30 - 32 mm

## ITEM NO. 1819-1018 1819 EMPTY PLASTBOX WITH EVA FOAM

5704196 014500 **WxDxH** 370 x 140 x 40 **0,3 KG**

## ITEM NO. 1821-1018 1821 EMPTY PLASTBOX WITH EVA FOAM

5704196 014548 **WxDxH** 370 x 140 x 40 **0,3 KG**

## 1820 1/2" METRIC SOCKET WRENCH SET

ITEM NO. 1820-0014

5704196 014555 **WxDxH** 370 x 140 x 40 **2,1 KG** **1**

- Set with long 6-point sockets from 10 to 24 mm supplied in plastbox with re-inforced EVA foam. 14 tools.



**14 TOOLS**

CONTENT:

QTY.	DESCRIPTION	SIZE
14	Long 6-point sockets	5012 1/2" L 10 - 11 - 12 - 13 - 14 - 15 - 16 - 17 - 18 - 19 - 20 - 21 - 22 - 24 mm

## 1822 1/2" INCH SOCKET WRENCH SET

ITEM NO. 1822-0017

5704196 014517 **WxDxH** 370 x 140 x 40 **1,8 KG** **1**

- Set with 6-point sockets from 3/8" to 1-1/4" supplied in plastbox with re-inforced EVA foam. 17 tools.



**17 TOOLS**

CONTENT:

QTY.	DESCRIPTION	SIZE
17	6-point sockets	5012 1/2" 3/8 - 7/16 - 1/2 - 9/16 - 19/32 - 5/8 - 11/16 - 3/4 - 25/32 - 13/16 - 7/8 - 15/16 - 1 - 1-1/16 - 1-1/8 - 1-3/16 - 1-1/4"

## ITEM NO. 1820-1014 1820 EMPTY PLASTBOX WITH EVA FOAM

5704196 014562 **WxDxH** 370 x 140 x 40 **0,3 KG**

## ITEM NO. 1822-1017 1822 EMPTY PLASTBOX WITH EVA FOAM

5704196 014524 **WxDxH** 370 x 140 x 40 **0,3 KG**



# POLAR® ROLLER CABINETS, ASSORTMENTS AND STORAGE



## 1823 1/2" TORX® SOCKET WRENCH SET

ITEM NO. 1823-0016

5704196 014579 **WxDxH** 370 x 140 x 40 **▲** 1,5 KG **📦** 1

- Set with Torx® sockets from T20 to T60 and NTX sockets from E12 to E24 supplied in plastbox with re-inforced EVA foam. 16 tools.



16  
TOOLS

**CONTENT:**

QTY.	DESCRIPTION	SIZE
9	Socket drivers for Torx® screws	5112 1/2" TX T20 - T25 - T27 - T30 - T40 - T45 - T50 - T55 - T60
7	Sockets for Torx® screws	5012 1/2" NTX E12 - E14 - E16 - E18 - E20 - E22 - E24

## 1825 1/2" SOCKET DRIVER SET

ITEM NO. 1825-0009

5704196 014616 **WxDxH** 370 x 140 x 40 **▲** 1,9 KG **📦** 1

- Set with long socket drivers for hex head screws from 5 to 19 mm supplied in plastbox with re-inforced EVA foam. 9 tools.



9  
TOOLS

**CONTENT:**

QTY.	DESCRIPTION	SIZE
9	Long socket drivers for hex head screws	5112 1/2" HL 5 - 6 - 7 - 8 - 10 - 12 - 14 - 17 - 19 mm

## ITEM NO. 1823-1016 1823 EMPTY PLASTBOX WITH EVA FOAM

5704196 014586 **WxDxH** 370 x 140 x 40 **▲** 0,3 KG

## ITEM NO. 1825-1009 1825 EMPTY PLASTBOX WITH EVA FOAM

5704196 014623 **WxDxH** 370 x 140 x 40 **▲** 0,3 KG

## 1824 1/2" SOCKET DRIVER SET

ITEM NO. 1824-0016

5704196 014593 **WxDxH** 370 x 140 x 40 **▲** 1,9 KG **📦** 1

- Set with socket drivers for slotted head, Phillips®, Pozidriv® and hex head screws supplied in plastbox with re-inforced EVA foam. 16 tools.



16  
TOOLS

**CONTENT:**

QTY.	DESCRIPTION	SIZE
3	Socket drivers for slotted head screws	5112 1/2" 8 - 10 - 12 mm
2	Socket drivers for Phillips® screws	5112 1/2" PH 3 - 4
2	Socket drivers for Pozidriv® screws	5112 1/2" PZ 3 - 4
9	Socket drivers for hex head screws	5112 1/2" H 5 - 6 - 7 - 8 - 10 - 12 - 14 - 17 - 19 mm

## 1826 1/2" SOCKET DRIVER SET

ITEM NO. 1826-0009

5704196 014630 **WxDxH** 370 x 140 x 40 **▲** 1,4 KG **📦** 1

- Set with long socket drivers for Torx® screws from T20 to T60 supplied in plastbox with re-inforced EVA foam. 9 tools.



9  
TOOLS

**CONTENT:**

QTY.	DESCRIPTION	SIZE
9	Long socket drivers for Torx® screws	5112 1/2" TXL - T20 - T25 - T27 - T30 - T40 - T45 - T50 - T55 - T60

## ITEM NO. 1824-1016 1824 EMPTY PLASTBOX WITH EVA FOAM

5704196 014609 **WxDxH** 370 x 140 x 40 **▲** 0,3 KG

## ITEM NO. 1826-1009 1826 EMPTY PLASTBOX WITH EVA FOAM

5704196 014647 **WxDxH** 370 x 140 x 40 **▲** 0,3 KG

## POLAR® ROLLER CABINETS, ASSORTMENTS AND STORAGE

### 1827 1/2" RATCHET AND ACCESSORIES

ITEM NO. 1827-0005

5704196 014654 **WxDxH** 370 x 140 x 40 **1,8 KG** **1**

- Set with reversible 72-teeth ratchet and accessories supplied in plastbox with re-inforced EVA foam. 5 tools.



**5 TOOLS**

**CONTENT:**

QTY.	DESCRIPTION	SIZE
1	Ratchet, 72-teeth	5312 1/2"
2	Extensions	5212 1/2" EX 125 - 250 mm
1	Sliding T-handle	5412 1/2" TH
1	Universal joint	5812 1/2" U

### 1829 B SCREWDRIVER SET FOR SLOTTED HEAD SCREWS

ITEM NO. 1829-0006

5704196 019536 **WxDxH** 370 x 140 x 40 **0,7 KG** **1**

- Set with screwdrivers for slotted head screws supplied in plastbox with re-inforced EVA foam. 6 tools.

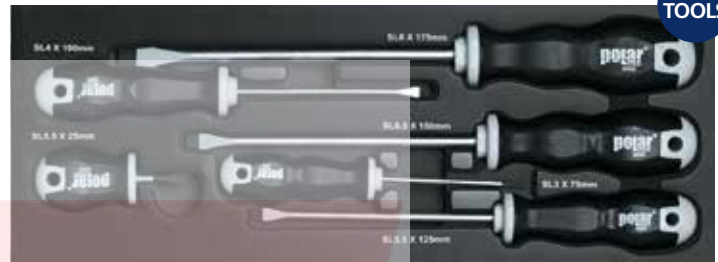

**6 TOOLS**

**CONTENT:**

QTY.	DESCRIPTION	SIZE
5	Screwdrivers for slotted screws	4000 3x75 - 4x100 - 5.5x125 - 6.5x150 - 8x175 mm
1	Stubby Screwdrivers for slotted screws	4003 5.5x25 mm

### ITEM NO. 1827-1005 1827 EMPTY PLASTBOX WITH EVA FOAM

5704196 014661 **WxDxH** 370 x 140 x 40 **0,3 KG**

### 1828 1/4" - 3/8" - 1/2" RATCHET AND ACCESSORIES

ITEM NO. 1828-0006

5704196 014678 **WxDxH** 370 x 140 x 40 **1,4 KG** **1**

- Set with 3 reversible ratchets and accessories supplied in plastbox with re-inforced EVA foam. 6 tools.



**6 TOOLS**

**CONTENT:**

QTY.	DESCRIPTION	SIZE
1	Ratchet, 60-teeth	5314 A 1/4"
1	Ratchet, 72-teeth	5338 3/8"
1	Ratchet, 72-teeth	5312 1/2"
1	Wobble extension	5214 1/4" EXW 100 mm
1	Wobble extension	5238 3/8" EXW 150 mm
1	Wobble extension	5212 1/2" EXW 150 mm

### ITEM NO. 1829-1006 1829 B EMPTY PLASTBOX WITH EVA FOAM

5704196 019543 **WxDxH** 370 x 140 x 40 **0,3 KG**



### ITEM NO. 1828-1006 1828 EMPTY PLASTBOX WITH EVA FOAM

5704196 014685 **WxDxH** 370 x 140 x 40 **0,3 KG**



# POLAR® ROLLER CABINETS, ASSORTMENTS AND STORAGE



## 1829 A SCREWDRIVER SET

ITEM NO. 1829-0012

5704196 013961 WxDxH 415 x 370 x 40 2,2 KG 1

- Set with screwdrivers for slotted head, Torx® and hex head screws supplied in plastbox with re-inforced EVA foam. 12 tools.



**CONTENT:**

QTY.	DESCRIPTION	SIZE
6	Screwdrivers for slotted screws	4000 3x75 - 4x100 - 5.5x125 - 6.5x150 - 8x175 - 10x200 mm
1	Stubby screwdriver for slotted screws	4003 5.5x25 mm
2	Screwdrivers for Torx® screws	4031 TX T30 - T40
2	Flexible hexagonal nut drivers	4042 F 6 - 7 mm
1	Flexible hexagonal nut driver	4042 F 1/4"

## ITEM NO. 1829-1012 1829 EMPTY PLASTBOX WITH EVA FOAM

5704196 014722 WxDxH 415 x 370 x 40 0,8 KG

## 1830 B SCREWDRIVER SET FOR POZIDRIV® SCREWS

ITEM NO. 1830-0005

5704196 019550 WxDxH 370 x 140 x 40 0,63 KG 1

- Set with screwdrivers for Pozidriv® screws supplied in plastbox with re-inforced EVA foam. 5 tools.

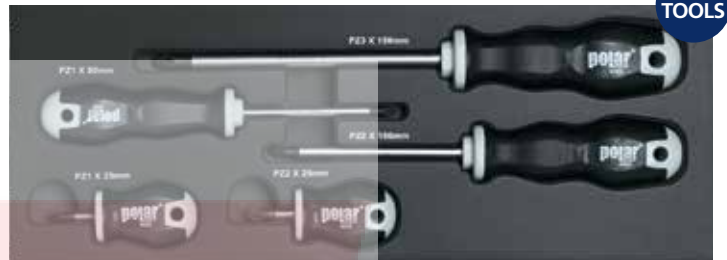

**CONTENT:**

QTY.	DESCRIPTION	SIZE
3	Screwdrivers for Pozidriv® screws	4020 PZ 1 - 2 - 3
2	Stubby screwdrivers for Pozidriv® screws	4023 PZ 1 - 2

## ITEM NO. 1830-1005 1830 B EMPTY PLASTBOX WITH EVA FOAM

5704196 019567 WxDxH 370 x 140 x 40 0,3 KG

## 1830 A SCREWDRIVER SET

ITEM NO. 1830-0006

5704196 013978 WxDxH 370 x 140 x 40 0,7 KG 1

- Set with screwdrivers for Philips® and Pozidriv® screws supplied in plastbox with re-inforced EVA foam. 6 tools.



**CONTENT:**



QTY.	DESCRIPTION	SIZE
2	Screwdrivers for Philips® screws	4010 PH 1 - 2
1	Stubby screwdriver for Philips® screws	4013 PH 1
2	Screwdrivers for Pozidriv® screws	4020 PZ 1 - 2
1	Stubby screwdriver for Pozidriv® screws	4023 PZ 1

## ITEM NO. 1830-1006 1830 EMPTY PLASTBOX WITH EVA FOAM

5704196 014739 WxDxH 370 x 140 x 40 0,3 KG

# POLAR® ROLLER CABINETS, ASSORTMENTS AND STORAGE

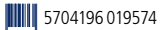
## 1830 C SCREWDRIVER SET FOR PHILIPS® SCREWS

ITEM NO. 1830-0106   5704196 019574 **WxDxH** 370 x 140 x 40  0,65 KG  1

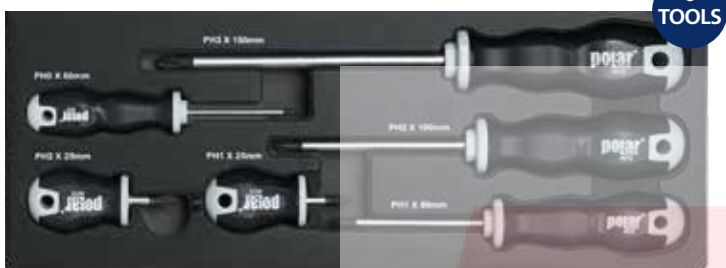

- Set with screwdrivers for Philips® screws supplied in plastbox with re-inforced EVA foam. 6 tools.



CONTENT:

QTY.	DESCRIPTION	SIZE
4	Screwdrivers for Phillips® screws	4010 PH 0 - 1 - 2 - 3
2	Stubby screwdrivers for Phillips® screws	4013 PH 1 - 2

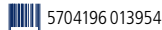
## 1831 B TORX® SCREWDRIVER SET

ITEM NO. 1831-0006   5704196 013954 **WxDxH** 370 x 140 x 40  0,7 KG  1

- Set with screwdrivers for Torx® screws supplied in plastbox with re-inforced EVA foam. 6 tools.

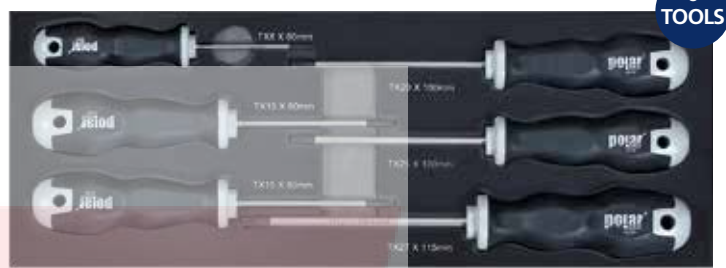

CONTENT:

QTY.	DESCRIPTION	SIZE
6	Screwdrivers for Torx® screws	4031 TX T8 - T10 - T15 - T20 - T25 - T27



## ITEM NO. 1830-1106 1830 C EMPTY PLASTBOX WITH EVA FOAM

 5704196 019581 **WxDxH** 370 x 140 x 40  0,3 KG

## ITEM NO. 1831-1006 1831 EMPTY PLASTBOX WITH EVA FOAM

 5704196 014715 **WxDxH** 370 x 140 x 40  0,3 KG

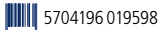
## 1831 A SCREWDRIVER SET FOR TORX® SCREWS

ITEM NO. 1831-0005   5704196 019598 **WxDxH** 370 x 140 x 40  0,67 KG  1

- Set with screwdrivers for Torx® screws supplied in plastbox with re-inforced EVA foam. 5 tools.



CONTENT:

QTY.	DESCRIPTION	SIZE
5	Screwdrivers for Torx® screws	4031 TX T20 - T25 - T27 - T30 - T40

## ITEM NO. 1831-1005 1831 A EMPTY PLASTBOX WITH EVA FOAM

 5704196 019604 **WxDxH** 370 x 140 x 40  0,3 KG

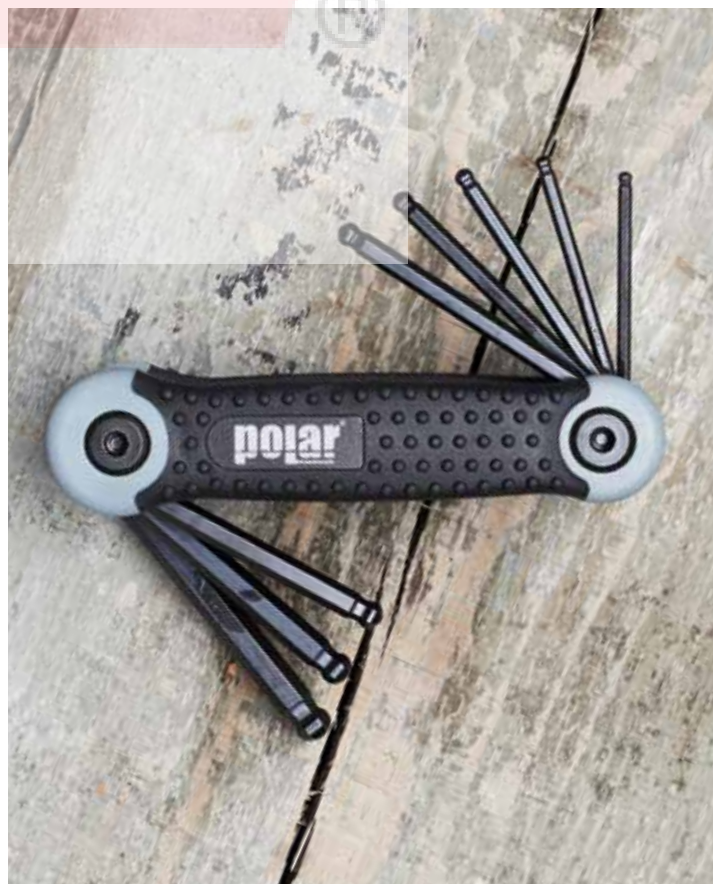

# POLAR® ROLLER CABINETS, ASSORTMENTS AND STORAGE



## 1832 3/4" METRIC SOCKET WRENCH SET

ITEM NO. 1832-0014

5704196 017143 WxDxH 415 x 370 x 40 10 KG 1

- Set with 6-point sockets from 22 to 50 mm and accessories supplied in plastic box with re-inforced EVA foam. The set is supplied with a reversible 40 teeth ratchet. 14 tools.

14 TOOLS



**CONTENT:**

QTY.	DESCRIPTION	SIZE
10	6-point sockets	5034 3/4" 22 - 24 - 27 - 30 - 32 - 36 - 38 - 41 - 46 - 50 mm
1	Ratchet, 40 teeth	5334 3/4"
2	Extensions	5234 3/4" EX 100 - 200 mm
1	Sliding T-handle	5434 3/4" TH

## ITEM NO. 1832-1014 1832 EMPTY PLASTBOX WITH EVA FOAM

5704196 017150 WxDxH 415 x 370 x 40 0,8 KG

## 1833 METRIC AND INCH HEXAGON KEY SET

ITEM NO. 1833-0038

5704196 013930 WxDxH 370 x 140 x 40 1,1 KG 1

- Set with long and short hexagon keys with spherical head in plastic box with re-inforced EVA foam. 38 tools

38 TOOLS

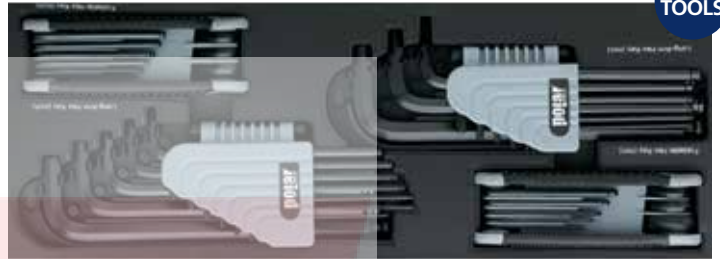

**CONTENT:**

QTY.	DESCRIPTION	SIZE
1	Hexagon key set	4195 FS 8 (1.5 - 2 - 2.5 - 3 - 4 - 5 - 6 - 8 mm)
1	Hexagon key set	4195 FIS 9 (5/64 - 3/32 - 7/64 - 1/8 - 9/64 - 5/32 - 3/16 - 7/32 - 1/4")
1	Long angled hexagon key set	4195 LS 9 (1.5 - 2 - 2.5 - 3 - 4 - 5 - 6 - 8 - 10 mm)
1	Long angled hexagon key set	4195 LIS 12 (1/16 - 5/64 - 3/32 - 7/64 - 1/8 - 9/64 - 5/32 - 3/16 - 7/32 - 1/4 - 5/16 - 3/8")

## ITEM NO. 1833-1038 1833 EMPTY PLASTBOX WITH EVA FOAM

5704196 014692 WxDxH 370 x 140 x 40 0,3 KG

## 1834 METRIC HEXAGON KEY SET AND TORX® KEY SET

ITEM NO. 1834-0034

5704196 013947 WxDxH 370 x 140 x 40 1,1 KG 1

- Set with long and short metric hexagon keys with spherical head and long and short Torx® hexagon keys in plastic box with re-inforced EVA foam. 34 tools.

34 TOOLS



**CONTENT:**

QTY.	DESCRIPTION	SIZE
1	Hexagon key set	4195 FS 8 (1.5 - 2 - 2.5 - 3 - 4 - 5 - 6 - 8 mm)
1	Torx® key set	4190 FTXS 8 (T9 - T10 - T15 - T20 - T25 - T27 - T30 - T40)
1	Long angled hexagon key set	4195 LS 9 (1.5 - 2 - 2.5 - 3 - 4 - 5 - 6 - 8 - 10 mm)
1	Long angled Torx® key set	4190 LTXS 9 (T8 - T10 - T15 - T20 - T25 - T27 - T30 - T40 - T50)

## ITEM NO. 1834-1034 1834 EMPTY PLASTBOX WITH EVA FOAM

5704196 014708 WxDxH 370 x 140 x 40 0,3 KG

# POLAR® ROLLER CABINETS, ASSORTMENTS AND STORAGE

## 1835 PLIER SET

ITEM NO. 1835-0004

5704196 013992 **WxDxH** 370 x 140 x 40 **1,3 KG** **1**

- Set with 4 pliers supplied in plastbox with re-inforced EVA foam. 4 tools.



**4 TOOLS**

**CONTENT:**

QTY.	DESCRIPTION	SIZE
1	Combination plier	3001 180 mm
1	Diagonal cutting plier	3004 180 mm
1	Long nose plier with half-round jaws	3005 200 mm
1	Long nose plier with half-round bent jaws	3006 200 mm

## 1837 ADJUSTABLE WRENCH SET

ITEM NO. 1837-0003

5704196 014067 **WxDxH** 370 x 140 x 40 **1,2 KG** **1**

- Set with 3 adjustable wrenches supplied in plastbox with re-inforced EVA foam. 3 tools.



**4 TOOLS**

**CONTENT:**

QTY.	DESCRIPTION	SIZE
3	Adjustable wrenches	2600 150 - 200 - 250 mm / 6" - 8" - 10"

## 1835 EMPTY PLASTBOX WITH EVA FOAM

5704196 014753 **WxDxH** 370 x 140 x 40 **0,3 KG**

## 1837 EMPTY PLASTBOX WITH EVA FOAM

5704196 014821 **WxDxH** 370 x 140 x 40 **0,3 KG**

## 1836 PLIER SET

ITEM NO. 1836-0002

5704196 014005 **WxDxH** 370 x 140 x 40 **1,2 KG** **1**

- Set with 2 pliers supplied in plastbox with re-inforced EVA foam. 2 tools.



**2 TOOLS**

**CONTENT:**

QTY.	DESCRIPTION	SIZE
1	Waterpump plier	3020 250 mm
1	Locking plier with curved jaws and cutter	3200 250 mm

## 1838 ERGONOMIC ADJUSTABLE WRENCH SET

ITEM NO. 1838-0003

5704196 014074 **WxDxH** 370 x 140 x 40 **1,1 KG** **1**

- Set with 3 adjustable wrenches supplied in plastbox with re-inforced EVA foam. 3 tools.



**3 TOOLS**

**CONTENT:**

QTY.	DESCRIPTION	SIZE
3	Adjustable wrenches, Ergo	2605 150 - 200 - 250 mm / 6" - 8" - 10"

## 1836 EMPTY PLASTBOX WITH EVA FOAM

5704196 014760 **WxDxH** 370 x 140 x 40 **0,3 KG**

## 1838 EMPTY PLASTBOX WITH EVA FOAM

5704196 014838 **WxDxH** 370 x 140 x 40 **0,3 KG**

**POLAR®**  
ROLLER CABINETS, ASSORTMENTS AND STORAGE



**1839 HAMMERS, CHISELS AND FILES SET**

ITEM NO. 1839-0011

5704196 014036 **WxDxH** 415 x 370 x 40 **3,7 KG** **1**

- Set with mechanics hammer, sledge hammer, chisels and files (second cut) supplied in plastbox with re-inforced EVA foam. 11 tools.



**11 TOOLS**

**CONTENT:**

QTY.	DESCRIPTION	SIZE
1	File set (second cut)	3990 S/5 (Flat - Halfround - Square - Round - Triangular)
1	Mechanics hammer	8030 300 g
1	Sledge hammer	8040 1000 g
2	Cape chisels	8215 5 - 7 mm
2	Flat chisels	8220 12 - 18 mm

ITEM NO. 1839-1011 **1839 EMPTY PLASTBOX WITH EVA FOAM**

5704196 014791 **WxDxH** 415 x 370 x 40 **0,8 KG**

**1840 IMPACT TOOL SET**

ITEM NO. 1840-0009

5704196 014012 **WxDxH** 370 x 140 x 40 **0,9 KG** **1**

- Set with pin punches, taper punches and center punch supplied in plastbox with re-inforced EVA foam. 9 tools.



**9 TOOLS**

**CONTENT:**

QTY.	DESCRIPTION	SIZE
6	Pin punches	8200 2 - 3 - 4 - 5 - 6 - 8 mm
2	Taper Punches	8205 3 - 4 mm
1	Center punch	8210 Size 2

ITEM NO. 1840-1009 **1840 EMPTY PLASTBOX WITH EVA FOAM**

5704196 014777 **WxDxH** 370 x 140 x 40 **0,3 KG**

**1841 PLIER SET FOR CIRCLIPS**

ITEM NO. 1841-0004

5704196 014128 **WxDxH** 370 x 140 x 40 **0,8 KG** **1**

- Set with pliers for internal and external circlips supplied in plastbox with re-inforced EVA foam. 4 tools.



**4 TOOLS**

**CONTENT:**

QTY.	DESCRIPTION	SIZE
1	Plier with straight jaws for internal circlips	3100 180 mm - Ø19 - 60 mm
1	Plier with nose bent 90° for internal circlips	3105 180 mm - Ø19 - 60 mm
1	Plier with straight jaws for external circlips	3110 180 mm - Ø19 - 60 mm
1	Plier with nose bent 90° for external circlips	3115 180 mm - Ø19 - 60 mm

ITEM NO. 1841-1004 **1841 EMPTY PLASTBOX WITH EVA FOAM**

5704196 014869 **WxDxH** 370 x 140 x 40 **0,3 KG**

# POLAR® ROLLER CABINETS, ASSORTMENTS AND STORAGE

## 1842 1/2" IMPACT SOCKET SET

ITEM NO. 1842-0016

5704196 014098 **WxDxH** 370 x 140 x 40 **2,5 KG** **1**

- Set with short and long impact sockets supplied in plastbox with re-inforced EVA foam. 16 tools.



**CONTENT:**

QTY.	DESCRIPTION	SIZE
12	6-point impact sockets	6012 1/2" 10 - 11 - 12 - 13 - 14 - 15 - 17 - 19 - 21 - 22 - 24 - 27 mm
4	Long 6-point impact sockets	6012 1/2" LT 17 - 19 - 21 - 22 mm

## ITEM NO. 1842-1016 1842 EMPTY PLASTBOX WITH EVA FOAM

5704196 014852 **WxDxH** 370 x 140 x 40 **0,3 KG**

## 1843 BITS SET

ITEM NO. 1843-0109

5704196 014081 **WxDxH** 370 x 140 x 40 **2,5 KG** **1**

- Set with 1/4" bits (103 pcs.), magnetic bit holding screwdriver and accessories supplied in plastbox with re-forced EVA foam. 109 tools.



**CONTENT:**

QTY.	DESCRIPTION	SIZE
1	Magnetic bit holding screwdriver	4043 1/4" M
1	Magnetic screwdriver bit socket	4714 1/4" M
1	Screwdriver bit socket	4714 1/4"
1	Flexible extension w/ Quick-Release screwdriver bit socket	4714 1/4" QRF
1	Socket adaptor	4714 1/4" SQ 25 mm
1	Socket adaptor	4714 1/4" SQ 50 mm
6	Bits for slotted head screws	4514 1/4" 3 - 3.5 - 4.5 - 5 - 5.5 - 6.5 mm
5	Bits for Phillips® screws	4514 1/4" PH 0 - 1 - 2 - 3 - 4
3	Bits for Phillips® screws	4514 1/4" ACR PH 1 - 2 - 3
1	Bits for Phillips® drywall screws	4514 1/4" PHR 2
5	Bits for Pozidriv® screws	4514 1/4" PZ 0 - 1 - 2 - 3 - 4
3	Bits for Pozidriv® screws	4514 1/4" ACR PZ 1 - 2 - 3
15	Bits for Torx® screws	4514 1/4" TX 5-6-7-8-9-10-15-20-25-27-30-40-45-50
11	Bits for Tamper Resistant® Torx® head screws	4514 1/4" STX 6-7-8-9-10-15-20-25-27-30-40
10	Bits for hex head screws	4514 1/4" H 1.5 - 2 - 2.5 - 3 - 4 - 5 - 5.5 - 6 - 7 - 8 mm
10	Bits for hex head bore hole screws	4514 1/4" HB 1.5 - 2 - 2.5 - 3 - 4 - 5 - 5.5 - 6 - 7 - 8 mm
6	Bits for hex head bore hole screws	4514 1/4" HB 5/64 - 3/32 - 7/64 - 1/8 - 9/64 - 5/32"
5	Bits for square head screws	4514 1/4" SQ 0 - 1 - 2 - 3 - 4
5	Bits for Spanner screws	4514 1/4" SN 4 - 6 - 8 - 10 - 12
5	Bits for Torq-Set® screws	4514 1/4" TS 4 - 6 - 8 - 10 - 1/4"
4	Bits for XZN screws	4514 1/4" XZN 4 - 5 - 6 - 8
5	Bits for Tri-Wing® screws	4514 1/4" TW 1 - 2 - 3 - 4 - 5
3	Bits for Clutch G screws	4514 1/4" CG 1 - 2 - 3
1	Bits for hooks	4514 1/4" HOOK

## ITEM NO. 1843-1109 1843 EMPTY PLASTBOX WITH EVA FOAM

5704196 014845 **WxDxH** 370 x 140 x 40 **0,3 KG**





# POLAR® ROLLER CABINETS, ASSORTMENTS AND STORAGE



## 1844 MEASURING AND CUTTING TOOLSET

ITEM NO. 1844-0005

5704196 014050 WxDxH 370 x 140 x 40 0,9 KG 1

- Set with vernier caliper, electrician's scissor, measuring tape and knives supplied in plastbox with re-inforced EVA foam. 5 tools.



5 TOOLS

CONTENT:

QTY.	DESCRIPTION	SIZE
1	Vernier caliper	9200 150 mm
1	Measuring tape	9400 5 mtr
1	Electrician scissor	3500 140 mm
2	Knives	9105 9 - 18 mm

## 1846 IMPACT ACCESSORIES

ITEM NO. 1846-0005

5704196 016030 WxDxH 370 x 140 x 40 1,4 KG 1

- Set with extensions, adapters and universal joint supplied in plastbox with re-inforced EVA foam. 5 tools.



5 TOOLS

CONTENT:

QTY.	DESCRIPTION	SIZE
2	Extensions	6212 1/2" EX 75 - 125 mm
2	Adapters	6734 3/4" A - 6638 3/8" A
1	Universal Joint	6812 1/2" U

## ITEM NO. 1844-1005 1844 EMPTY PLASTBOX WITH EVA FOAM

5704196 014814 WxDxH 370 x 140 x 40 0,3 KG

## ITEM NO. 1846-1005 1846 EMPTY PLASTBOX WITH EVA FOAM

5704196 015378 WxDxH 370 x 140 x 40 0,3 KG

## 1845 MEASURING AND CUTTING TOOLSET

ITEM NO. 1845-0003

5704196 014029 WxDxH 370 x 140 x 40 0,8 KG 1

- Set with junior hacksaw, measuring tape and knife supplied in plastbox with re-inforced EVA foam. 3 tools.



5 TOOLS

CONTENT:

QTY.	DESCRIPTION	SIZE
1	Junior hacksaw	9210 150 mm
1	Knife	9105 18 mm
1	Measuring tape	9400 5 mtr

## 1847 IMPACT DRIVER BIT SET

ITEM NO. 1847-0015

5704196 015361 WxDxH 370 x 140 x 40 1,1 KG 1

- Set with 1/2" impact driver and 5/16" bits supplied in plastbox with re-inforced EVA foam. 15 tools.



15 TOOLS

CONTENT:

QTY.	DESCRIPTION	SIZE
1	Impact Driver	4712 1/2" ID
1	Screwdriver bit socket	4712 1/2" IB 1/2" x 5/16"
3	Bits for slotted head screws	4516 5/16" 8 - 10 - 12 mm
3	Bits for Phillips® screws	4516 5/16" ACR PH 2 - 3 - 4
4	Bits for Torx® screws	4516 5/16" TX T40 - T45 - T50 - T55
3	Bits for hex head screws	4516 5/16" H 5 - 6 - 8 mm

## ITEM NO. 1845-1003 1845 EMPTY PLASTBOX WITH EVA FOAM

5704196 014784 WxDxH 370 x 140 x 40 0,3 KG

## ITEM NO. 1847-1015 1847 EMPTY PLASTBOX WITH EVA FOAM



5704196 015378 WxDxH 370 x 140 x 40 0,3 KG

**polar**

**POLAR®**

### 1848 SCREWDRIVER SET WITH BALL-POINT FOR HEX HEAD SCREWS

ITEM NO. 1848-0005 

 5704196 019611 **WxDxH** 370 x 140 x 40  0,54 KG  1

- Set with screwdrivers with ball-point for hex head screws supplied in plastbox with re-inforced EVA foam. 5 tools.

**5 TOOLS**

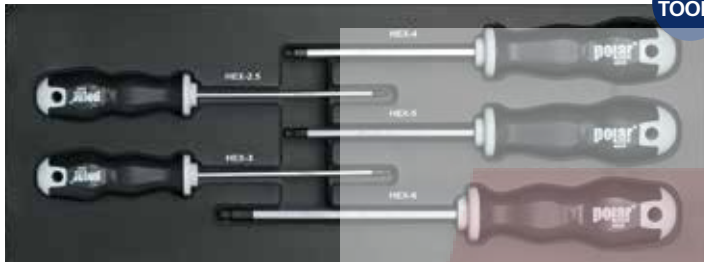

**CONTENT:**

QTY.	DESCRIPTION	SIZE
5	Screwdrivers with ball-point for hex head screws	4035 HBP 2.5 - 3 - 4 - 5 - 6 mm

### ITEM NO. 1848-1005 1848 EMPTY PLASTBOX WITH EVA FOAM

 5704196 019628 **WxDxH** 370 x 140 x 40  0,3 KG

### 1849 SCREWDRIVER SET FOR TORX® SCREWS, HEXAGONAL NUT DRIVERS AND MAGNETIC BIT HOLDER

ITEM NO. 1849-0005  

 5704196 019635 **WxDxH** 370 x 140 x 40  0,74 KG  1

- Set with screwdrivers for Torx® screws, hexagonal nut drivers and magnetic bit holder supplied in plastbox with re-inforced EVA foam. 5 tools.

**5 TOOLS**



**CONTENT:**

QTY.	DESCRIPTION	SIZE
2	Screwdrivers for Torx® screws	4031 TX T10 - T15
2	Flexible hexagonal nut drivers	4042 F 1/4" - 7 mm
1	Magnetic bit holding screwdriver	4043 1/4" M

### ITEM NO. 1849-1005 1849 EMPTY PLASTBOX WITH EVA FOAM

 5704196 019642 **WxDxH** 370 x 140 x 40  0,3 KG





# POLAR® ROLLER CABINETS, ASSORTMENTS AND STORAGE



## 1875 S1 TOOL SET - 350 TOOLS

ITEM NO. 1875-0350

5704196 020259 44 KG

SUITABLE FOR

EASY - page 39  
X-LARGE - page 42-43  
CARGO - page 26-27

350  
TOOLS

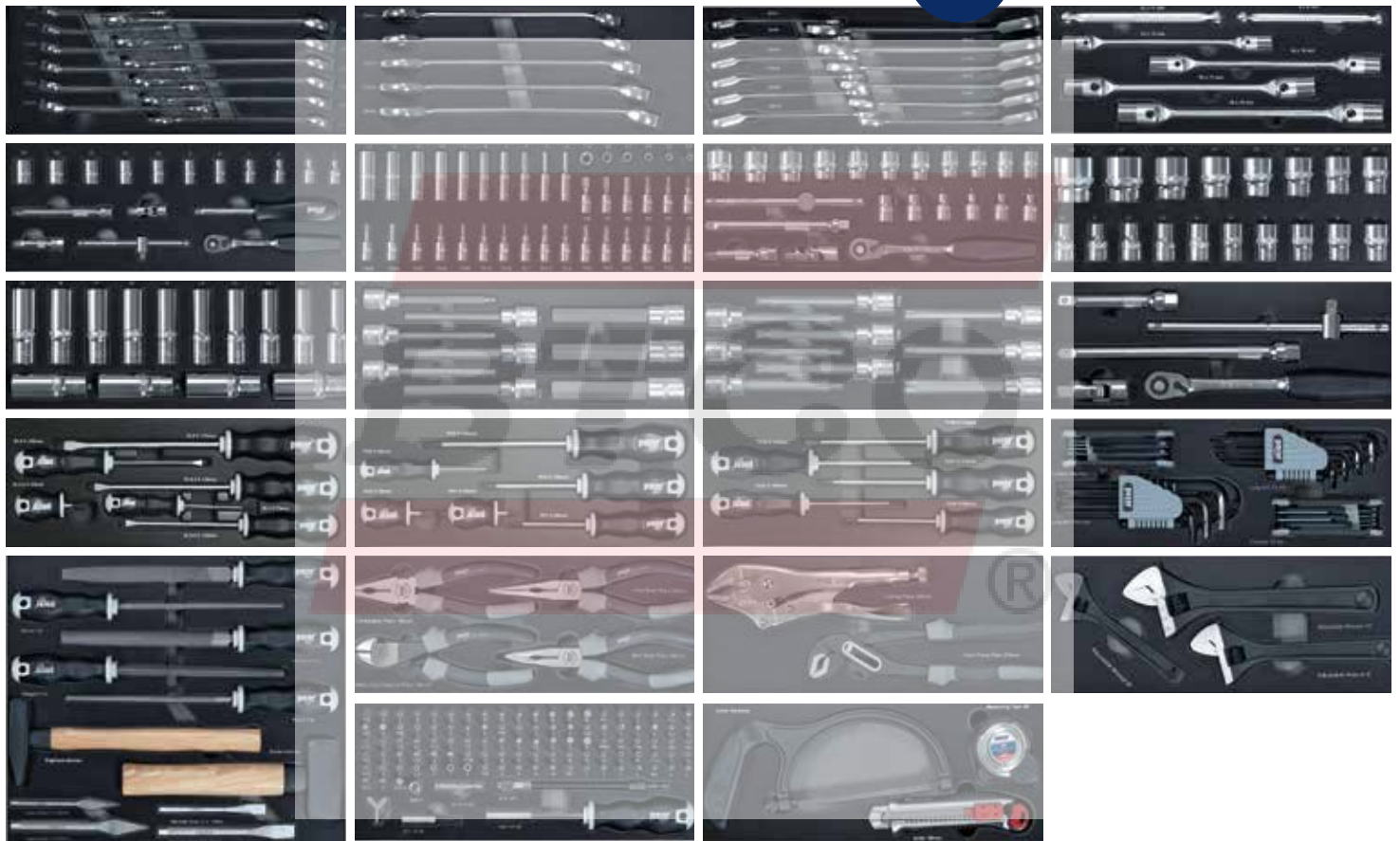

### CONTENT:

- 1800 Combination wrench set 8 - 19 mm
- 1801 Combination wrench set 20 - 24 mm
- 1807 Reversible ratchet combination wrench set 8 - 19 mm
- 1812 Double swivel end socket wrench set 8 - 19 mm
- 1813 1/4" Socket wrench set 4 - 14 mm
- 1815 1/4" Long sockets and socket drivers
- 1817 3/8" Socket wrench set 6 - 22 mm
- 1819 1/2" Socket wrench set 10 - 32 mm
- 1820 1/2" Long sockets 10 - 24 mm
- 1825 1/2" Long socket drivers for hex head screws 5 - 19 mm
- 1826 1/2" Long socket drivers for Torx® screws T10 - T50
- 1827 1/2" Ratchet and accessories
- 1829 B Screwdriver set for slotted head screws
- 1830 C Screwdriver set, PH
- 1831 A Screwdriver set, TX
- 1834 Metric and Torx® hexagon key set
- 1835 Plier set with combination-, cutting- and long nose plier
- 1836 Plier set with waterpump- and locking plier
- 1837 Adjustable wrenches 6" - 8" - 10"
- 1839 Hammers, chisels and files set
- 1843 Bits set
- 1845 Measuring and cutting tool set

# POLAR® ROLLER CABINETS, ASSORTMENTS AND STORAGE

## 1875 S2 TOOL SET - 425 TOOLS

ITEM NO. 1875-0425

5704196 020365

53 KG

**SUITABLE FOR**

EASY - page 40

**425  
TOOLS**



**CONTENT:**

- 1800 Combination wrench set 8 - 19 mm
- 1801 Combination wrench set 20 - 24 mm
- 1807 Reversible ratchet combination wrench set 8 - 19 mm
- 1812 Double swivel end socket wrench set 8 - 19 mm
- 1813 1/4" Socket wrench set 4 - 14 mm
- 1815 1/4" Long sockets and socket drivers
- 1817 3/8" Socket wrench set 6 - 22 mm
- 1819 1/2" Socket wrench set 10 - 32 mm
- 1820 1/2" Long sockets 10 - 24 mm
- 1824 1/2" Socket drivers for slot-head, Phillips®, Pozidriv® and hexagonal screws

- 1825 1/2" Long socket drivers for hex head screws 5 - 19 mm
- 1826 1/2" Long socket drivers for Torx® screws T10 - T50
- 1827 1/2" Ratchet and accessories
- 1829 B Screwdriver set for slotted head screws
- 1830 A Screwdriver set for Phillips® and Pozidriv® screws
- 1831 A Screwdriver set, TX
- 1834 Metric and Torx® hexagon key set
- 1835 Plier set with combination-, cutting- and long nose pliers
- 1836 Plier set with waterpump- and locking pliers
- 1837 Adjustable wrenches 6" - 8" - 10"

- 1839 Hammers, chisels and files set
- 1840 Impact tool set
- 1841 Plier set for circlips 19 - 60 mm
- 1842 1/2" Impact socket set
- 1843 Bits set
- 1844 Measuring and cutting tool set
- 1845 Measuring and cutting tool set
- 1847 Impact driver bit set
- 1848 Screwdriver set, hex
- 1849 Screwdriver set



**BOLTSANDTOOLS**<sup>®</sup>

**polar**<sup>®</sup>  
MULTI-PURPOSE

**EASY**

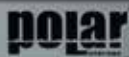

# POLAR® ROLLER CABINETS, ASSORTMENTS AND STORAGE

## 1875 S3 TOOL SET - 470 TOOLS

**SUITABLE FOR**

X-LARGE - page 46-47

ITEM NO. 1875-0470

5704196 015385 52 KG

**470  
TOOLS**

METRIC SOCKETS, SOCKET DRIVERS AND ACCESSORIES, TORQUE WRENCHES

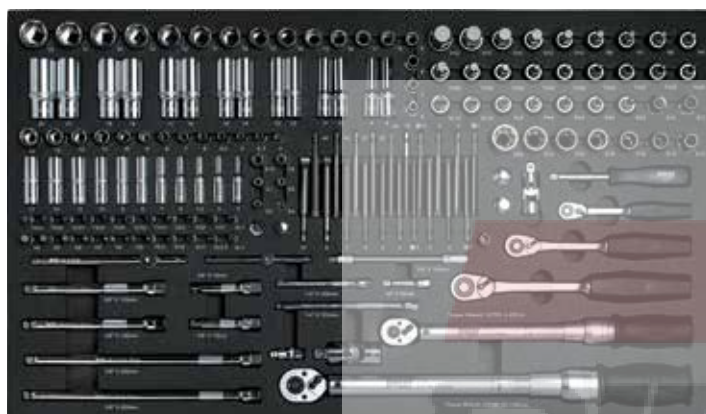

**CONTENT:**

QTY.	DESCRIPTION	SIZE
13	6-point sockets	5014 1/4" 4 - 4.5 - 5 - 5.5 - 6 - 7 - 8 - 9 - 10 - 11 - 12 - 13 - 14 mm
11	Long 6-point sockets	5014 1/4" L4 - 5 - 5.5 - 6 - 7 - 8 - 9 - 10 - 11 - 12 - 13 - mm
3	Socket drivers for slotted head screws	5114 1/4" 4 - 5.5 - 7 mm
3	Socket drivers for Phillips® screws	5114 1/4" PH 1 - 2 - 3
3	Socket drivers for Pozidriv® screws	5114 1/4" PZ 1 - 2 - 3
6	Socket drivers for hex head screws	5114 1/4" H 3 - 4 - 5 - 6 - 7 - 8 mm
7	Socket drivers for Tamper Resistant® Torx® screws	5114 1/4" STX T10 - T15 - T20 - T25 - T27 - T30 - T40
6	Socket for Torx® screws	5014 1/4" NTX E4 - E5 - E6 - E7 - E8 - E10
1	Screwdriver bit socket	4714 1/4" x 1/4"
3	Extensions	5214 1/4" EX 50 - 100 - 150 mm
1	Flexible extension	5214 1/4" F 150 mm
1	Adaptor	5614 1/4" A
1	Universal joint	5814 1/4" U
1	Sliding T-handle	5414 1/4" TH
1	Spinner handle	5514 1/4" HD
1	Ratchet, 60 teeth	5314 1/4" A
17	6-point sockets	5038 3/8" 6 - 7 - 8 - 9 - 10 - 11 - 12 - 13 - 14 - 15 - 16 - 17 - 18 - 19 - 20 - 21 - 22 mm
14	Long 6-point sockets	5038 3/8" L8 - 9 - 10 - 11 - 12 - 13 - 14 - 15 - 16 - 17 - 18 - 19 - 21 - 22 mm
3	Extensions	5238 3/8" EX 75 - 150 - 250 mm
3	Wobble extensions	5238 3/8" EXW 75 - 150 - 250 mm
1	Adaptor	5738 3/8" A
1	Adaptor	5638 3/8" A
1	Universal joint	5838 3/8" U
1	Sliding T-handle	5438 3/8" TH
1	Ratchet, 72 teeth	5338 3/8"
3	Socket drivers for slotted head screws	5112 1/2" 8 - 10 - 12 mm
2	Socket drivers for Phillips® screws	5112 1/2" PH 3 - 4
2	Socket drivers for Pozidriv® screws	5112 1/2" PZ 3 - 4
9	Socket drivers for hex head screws	5112 1/2" H 5 - 6 - 7 - 8 - 10 - 12 - 14 - 17 - 19 mm
9	Socket drivers for Torx® screws	5112 1/2" TX T20 - T25 - T27 - T30 - T40 - T45 - T50 - T55 - T60
9	Socket for Torx® screws	5012 1/2" NTX E10 - E11 - E12 - E14 - E16 - E18 - E20 - E22 - E24
1	Universal joint	5812 1/2" U
1	Adaptor	5712 1/2" A
1	Ratchet, 72 teeth	5312 1/2"
7	Long bits for slotted head screws	4614 1/4" 3 - 4 - 5 - 6 - 7 - 8 - 10 mm
3	Long bits for Phillips® screws	4614 1/4" ACR PH 1 - 2 - 3
3	Long bits for Pozidriv® screws	4614 1/4" ACR PZ 1 - 2 - 3
7	Long bits for Tamper Resistant® Torx® screws	4614 1/4" STX T10 - T15 - T20 - T25 - T25 - T27 - T30 - T40
1	Torque-wrench	7114 1/4" 4-20 Nm
1	Torque-wrench	7138 3/8" 20-120 Nm

SOCKET WRENCH SET, TORQUE WRENCH



**CONTENT:**

QTY.	DESCRIPTION	SIZE
24	6-point sockets	5012 1/2" 8 - 9 - 10 - 11 - 12 - 13 - 14 - 15 - 16 - 17 - 18 - 19 - 20 - 21 - 22 - 23 - 24 - 25 - 26 - 27 - 28 - 29 - 30 - 32 mm
14	Long 6-point sockets	5012 1/2" L 10 - 11 - 12 - 13 - 14 - 15 - 16 - 17 - 18 - 19 - 20 - 21 - 22 - 24 mm
9	Long socket drivers for hex head screws	5112 1/2" H 5 - 6 - 7 - 8 - 10 - 12 - 14 - 17 - 19 mm
9	Long socket drivers for Torx® screws	5112 1/2" TX T20 - T25 - T27 - T30 - T40 - T45 - T50 - T55 - T60
3	Extensions	5212 1/2" EX 75 - 125 - 250 mm
3	Wobble extensions	5212 1/2" EXW 75 - 125 - 250 mm
1	Swivel handle	5912 1/2" FH 410 mm
1	Sliding T-handle	5412 1/2" TH
1	Ratchet, 72 teeth	5312 1/2"
1	Torque-wrench	7112 1/2" 60-340 NM
2	Spark plug sockets	5038 3/8" SP 16 - 21 mm

SCREWDRIVER SET



**CONTENT:**

QTY.	DESCRIPTION	SIZE
6	Screwdrivers for slotted screws	4000 3x75 - 4x100 - 5,5x125 - 6,5x150 - 8x175 - 10x200 mm
2	Stubby screwdrivers for slotted screws	4003 5,5x25 - 6,5x25 mm
4	Screwdrivers for Phillips® screws	4010 PH 0 - 1 - 2 - 3
2	Stubby screwdrivers for Phillips® screws	4013 PH 1 - 2
3	Screwdrivers for Pozidriv® screws	4020 PZ 1 - 2 - 3
2	Stubby screwdrivers for Pozidriv® screws	4023 PZ 1 - 2
8	Screwdrivers for Torx® screws	4031 TX T8 - T10 - T15 - T20 - T25 - T25 - T30 - T40
3	Flexible hexagonal nut drivers	4042 F 1/4" - 6 - 7 mm
1	Magnetic bit holding screwdriver	4043 M 1/4"



# POLAR® ROLLER CABINETS, ASSORTMENTS AND STORAGE



COMB. AND DOUBLE SWIVEL END SOCKET WRENCHES, REVERSIBLE GEAR COMB. WRENCHES



**CONTENT:**

QTY.	DESCRIPTION	SIZE
26	Combination wrenches	2000 6 - 7 - 8 - 9 - 10 - 11 - 12 - 13 - 14 - 15 - 16 - 17 - 18 - 19 - 20 - 21 - 22 - 23 - 24 - 25 - 26 - 27 - 28 - 29 - 30 - 32 mm
12	Reversible gear combination wrenches	2005 8 - 9 - 10 - 11 - 12 - 13 - 14 - 15 - 16 - 17 - 18 - 19 mm
7	Offset combination wrenches	2100 8 - 10 - 12 - 13 - 15 - 17 - 19 mm
6	Double swivel end socket wrenches	2400 8x9 - 10x11 - 12x13 - 14x15 - 16x17 - 18x19 mm

IMPACT DRIVER, ADJUSTABLE WRENCHES, HEXAGONAL KEYS, FILES AND MEASURING TOOLS



**CONTENT:**

QTY.	DESCRIPTION	SIZE
9	Long angled Torx® keys	4131 TX T8 - T10 - T15 - T20 - T25 - T27 - T30 - T40 - T50
9	Long angled ball-point hexagon keys	4105 BP 1,5 - 2 - 2,5 - 3 - 4 - 5 - 6 - 8 - 10 mm
8	Foldable ball-point key set for hex head screws	4195 FS/8 1,5 - 2 - 2,5 - 3 - 4 - 5 - 6 - 8 mm
8	Foldable key set for Torx® screws	4190 FTXS/8 TX T9 - T10 - T15 - T20 - T25 - T27 - T30 - T40
4	Adjustable wrenches	2600 6" - 8" - 10" - 12"
1	Vernier caliper	9200 150 mm
1	Measuring tape	9400 3 mtr.
1	Flat file	3900 200 mm
1	Round file	3901 200 mm
1	Halfround file	3902 200 mm
1	Square file	3903 200 mm
1	Triangular file	3904 200 mm
3	Bits for slotted head screws	4516 5/16" 8 - 10 - 12 mm
3	Bits for Phillips® screws	4516 5/16" ACR PH 2 - 3 - 4
4	Bits for Torx® screws	4516 5/16" TX T40 - T45 - T50 - T55
5	Bits for hex head screws	4516 5/16" H 5 - 6 - 8 - 10 - 12 mm
1	Screwdriver bit socket	4712 1/2" x 5/16"
1	Impact bit driver	4712 1/2 ID

BITS, HAMMERS AND IMPACT TOOLS

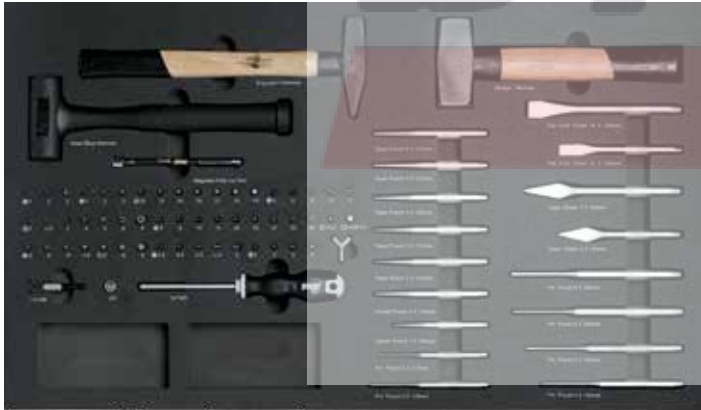

**CONTENT:**

QTY.	DESCRIPTION	SIZE
1	Engineers hammer, 300 g	8030 300 g
1	Sledge hammer 1000 g	8040 1000 g
1	Dead blow hammer, 30 mm	8060 30 mm
6	Pin punches	8200 2 - 3 - 4 - 5 - 6 - 8 mm
5	Taper punches	8205 2 - 3 - 4 - 5 - 6 mm
2	Center punches	8210 sizes 1 - 2
2	Cape chisels	8215 5 - 7 mm
2	Flat cold chisels	8220 12 - 18 mm
1	Magnetic pick-up tool	9000 2,2 kg
1	Magnetic bit holding screwdriver	4043 1/4" M
1	Quick-Release screwdriver bit socket	4714 1/4" QR
1	Screwdriver bit socket	4714 1/4"
1	Socket adaptor	4714 1/4" SQ 25 mm
5	Bits for slotted head screws	4514 1/4" 3.5 - 4.5 - 5.5 - 6.5 - 8 mm
3	Bits for Phillips® screws	4514 1/4" ACR PH 1 - 2 - 3
3	Bits for Pozidriv® screws	4514 1/4" ACR PZ 1 - 2 - 3
7	Bits for Torx® screws	4514 1/4" TX T10 - T15 - T20 - T25 - T27 - T30 - T40
9	Bits for Tamper Resistant® Torx® head screws	4514 1/4" STX T8 - T9 - T10 - T15 - T20 - T25 - T27 - T30 - T40
7	Bits for hex head bore hole screws	4514 1/4" HB 2 - 2.5 - 3 - 4 - 5 - 6 - 8 mm
1	Bits for square head screws	4514 1/4" SQ 2
5	Bits for spanner screws	4514 1/4" SN 4 - 6 - 8 - 10 - 12
4	Bits for Torq-Set® screws	4514 1/4" TS 6 - 8 - 10 mm / 1/4"
3	Bits for XZN screws	4514 1/4" XZN 5 - 6 - 8
4	Bits for Tri-Wing® screws	4514 1/4" TW 2 - 3 - 4 - 5
1	Bits for hooks	4514 1/4" HOOK

PLIERS, CIRCLIPS PLIERS AND CUTTING TOOLS



**CONTENT:**

QTY.	DESCRIPTION	SIZE
1	Combination plier	3001 180 mm
1	Long nose plier	3005 160 mm
1	Bent nose plier	3006 160 mm
1	Diagonal plier	3002 160 mm
1	Water pump plier	3020 250 mm
1	Internal circlip plier, straight	3100 180 mm - Ø19 - 60 mm
1	Internal circlip plier, bent	3105 180 mm - Ø19 - 60 mm
1	External circlip plier, straight	3110 180 mm - Ø19 - 60 mm
1	External circlip plier, bent	3115 180 mm - Ø19 - 60 mm
1	Locking plier, curved jaw, w/wire cutter	3200 180 mm
1	Tinmans shears (straight)	3410 250 mm
1	Electronic scissor	3500 140 mm - 3,0 mm
1	Knife	9105 18 mm
1	Junior hacksaw	9210 150 mm
1	Wire stripper	3009 160 mm



# POLAR® ROLLER CABINETS, ASSORTMENTS AND STORAGE

## 1875 S4 TOOL SET - 66 TOOLS

ITEM NO. 1875-0066

5704196 018560 9,3 KG

SUITABLE FOR

MINI - page 83  
TOOL BOX A2 - page 83



CONTENT:

QTY.	DESCRIPTION	SIZE
18	6-point sockets	5012 1/2" 10 - 11 - 12 - 13 - 14 - 15 - 16 - 17 - 18 - 19 - 20 - 21 - 22 - 23 - 24 - 27 - 30 - 32 mm
1	Ratchet, 72 teeth	5312 1/2"
2	Extensions	5212 1/2" EX 125 - 250 mm
1	Sliding T-handle	5412 1/2" TH
1	Universal joint	5812 1/2" U
4	Screwdrivers for slotted head screws	4000 3x75 - 4x100 - 5,5x125 - 6,5x150 mm
3	Screwdrivers for Phillips® screws	4010 PH 1 - PH 2 - PH 3
14	Combination wrenches	2000 8 - 9 - 10 - 11 - 12 - 13 - 14 - 15 - 16 - 17 - 18 - 19 - 21 - 22 mm
1	Combination plier	3001 180 mm
1	Diagonal cutter	3002 160 mm
1	Half-round long nose plier	3005 160 mm
1	Waterpump plier	3020 250 mm
1	Locking plier	3202 250 mm
1	Electricians scissor	3500 140 mm
9	Long metric hexagon keys	4105 BP 1.5 - 2 - 2.5 - 3 - 4 - 5 - 6 - 8 - 10 mm
1	Mechanics hammer	8030 300 g
1	Taper punch	8205 3 x 120 mm
1	Center punch	8210 2 x 120 mm
1	Cape chisel	8215 5 x 130 mm
1	Flat chisel	8220 12 x 130 mm
1	Pin punch	8200 4 x 150 mm
1	Hacksaw	9210 300 mm



POLAR®

polar

## 1875 S5 TOOL SET - 163 TOOLS

ITEM NO. 1875-0163

5704196 020273

26 KG

**SUITABLE FOR**

*EASY* - page 38

*CARGO* - page 26-27

163  
TOOLS



### CONTENT:

- 1800 Combination wrench set 8 - 19 mm
- 1801 Combination wrench set 20 - 24 mm
- 1814 1/4" Socket wrench set 4 - 14 mm
- 1819 1/2" Socket wrench set 10 - 32 mm
- 1827 1/2" Ratchet and accessories
- 1829 B Screwdriver set for slotted head screws
- 1830 C Screwdriver set, PH
- 1831 A Screwdriver set, TX
- 1834 Metric and Torx® hexagon key set
- 1835 Plier set with combination-, cutting- and long nose plier
- 1836 Plier set with waterpump- and locking plier
- 1845 Measuring and cutting toolset

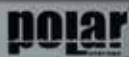

# POLAR® ROLLER CABINETS, ASSORTMENTS AND STORAGE

## 1875 S6 TOOL SET - 473 TOOLS

**SUITABLE FOR**

X-LARGE - page 48-49

ITEM NO. 1875-0473

5704196018638 53 KG

**473  
TOOLS**

METRIC SOCKETS, SOCKET DRIVERS AND ACCESSORIES, TORQUE WRENCHES

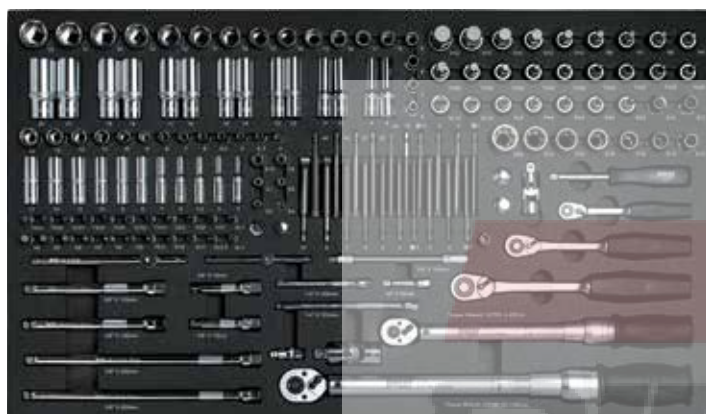

CONTENT:

QTY.	DESCRIPTION	SIZE
13	6-point sockets	5014 1/4" 4 - 4,5 - 5 - 5,5 - 6 - 7 - 8 - 9 - 10 - 11 - 12 - 13 - 14 mm
11	Long 6-point sockets	5014 1/4" L 4 - 5 - 5,5 - 6 - 7 - 8 - 9 - 10 - 11 - 12 - 13 - mm
3	Socket drivers for slotted head screws	5114 1/4" 4 - 5,5 - 7 mm
3	Socket drivers for Phillips® screws	5114 1/4" PH 1 - 2 - 3
3	Socket drivers for Pozidriv® screws	5114 1/4" PZ 1 - 2 - 3
6	Socket drivers for hex head screws	5114 1/4" H 3 - 4 - 5 - 6 - 7 - 8 mm
7	Socket drivers for Tamper Resistant® Torx® screws	5114 1/4" STX T10 - T15 - T20 - T25 - T27 - T30 - T40
6	Socket for Torx® screws	5014 1/4" NTX E4 - E5 - E6 - E7 - E8 - E10
1	Screwdriver bit socket	4714 1/4" x 1/4"
3	Extensions	5214 1/4" EX 50 - 100 - 150 mm
1	Flexible extension	5214 1/4" F 150 mm
1	Adaptor	5614 1/4" A
1	Universal joint	5814 1/4" U
1	Sliding T-handle	5414 1/4" TH
1	Spinner handle	5514 1/4" HD
1	Ratchet, 60 teeth	5314 1/4" A
17	6-point sockets	5038 3/8" 6 - 7 - 8 - 9 - 10 - 11 - 12 - 13 - 14 - 15 - 16 - 17 - 18 - 19 - 20 - 21 - 22 mm
14	Long 6-point sockets	5038 3/8" L 8 - 9 - 10 - 11 - 12 - 13 - 14 - 15 - 16 - 17 - 18 - 19 - 21 - 22 mm
3	Extensions	5238 3/8" EX 75 - 150 - 250 mm
3	Wobble extensions	5238 3/8" EXW 75 - 150 - 250 mm
1	Adaptor	5738 3/8" A
1	Adaptor	5638 3/8" A
1	Universal joint	5838 3/8" U
1	Sliding T-handle	5438 3/8" TH
1	Ratchet, 72 teeth	5338 3/8"
3	Socket drivers for slotted head screws	5112 1/2" 8 - 10 - 12 mm
2	Socket drivers for Phillips® screws	5112 1/2" PH 3 - 4
2	Socket drivers for Pozidriv® screws	5112 1/2" PZ 3 - 4
9	Socket drivers for hex head screws	5112 1/2" H 5 - 6 - 7 - 8 - 10 - 12 - 14 - 17 - 19 mm
9	Socket drivers for Torx® screws	5112 1/2" TX T20 - T25 - T27 - T30 - T40 - T45 - T50 - T55 - T60
9	Socket for Torx® screws	5012 1/2" NTX E10 - E11 - E12 - E14 - E16 - E18 - E20 - E22 - E24
1	Universal joint	5812 1/2" U
1	Adaptor	5712 1/2" A
1	Ratchet, 72 teeth	5312 1/2"
7	Long bits for slotted head screws	4614 1/4" 3 - 4 - 5 - 6 - 7 - 8 - 10 mm
3	Long bits for Phillips® screws	4614 1/4" ACR PH 1 - 2 - 3
3	Long bits for Pozidriv® screws	4614 1/4" ACR PZ 1 - 2 - 3
7	Long bits for Tamper Resistant® Torx® screws	4614 1/4" STX T10 - T15 - T20 - T25 - T25 - T27 - T30 - T40
1	Torque-wrench	7114 1/4" 4-20 Nm
1	Torque-wrench	7138 3/8" 20-120 Nm

SOCKET WRENCH SET, TORQUE WRENCH



CONTENT:

QTY.	DESCRIPTION	SIZE
24	6-point sockets	5012 1/2" 8 - 9 - 10 - 11 - 12 - 13 - 14 - 15 - 16 - 17 - 18 - 19 - 20 - 21 - 22 - 23 - 24 - 25 - 26 - 27 - 28 - 29 - 30 - 32 mm
14	Long 6-point sockets	5012 1/2" L 10 - 11 - 12 - 13 - 14 - 15 - 16 - 17 - 18 - 19 - 20 - 21 - 22 - 24 mm
9	Long socket drivers for hex head screws	5112 1/2" H 5 - 6 - 7 - 8 - 10 - 12 - 14 - 17 - 19 mm
9	Long socket drivers for Torx® screws	5112 1/2" TX T20 - T25 - T27 - T30 - T40 - T45 - T50 - T55 - T60
3	Extensions	5212 1/2" EX 75 - 125 - 250 mm
3	Wobble extensions	5212 1/2" EXW 75 - 125 - 250 mm
1	Swivel handle	5912 1/2" FH 410 mm
1	Sliding T-handle	5412 1/2" TH
1	Ratchet, 72 teeth	5312 1/2"
1	Torque-wrench	7112 1/2" 60-340 NM
2	Spark plug sockets	5038 3/8" SP 16 - 21 mm

SCREWDRIVER SET



CONTENT:

QTY.	DESCRIPTION	SIZE
6	Screwdrivers for slotted screws	4000 3x75 - 4x100 - 5,5x125 - 6,5x150 - 8x175 - 10x200 mm
2	Stubby screwdrivers for slotted screws	4003 5,5x25 - 6,5x25 mm
4	Screwdrivers for Phillips® screws	4010 PH 0 - 1 - 2 - 3
2	Stubby screwdrivers for Phillips® screws	4013 PH 1 - 2
3	Screwdrivers for Pozidriv® screws	4020 PZ 1 - 2 - 3
2	Stubby screwdrivers for Pozidriv® screws	4023 PZ 1 - 2
8	Screwdrivers for Torx® screws	4031 TX T8 - T10 - T15 - T20 - T25 - T25 - T30 - T40
3	Flexible hexagonal nut drivers	4042 F 1/4" - 6 - 7 mm
1	Magnetic bit holding screwdriver	4043 M 1/4"



# POLAR® ROLLER CABINETS, ASSORTMENTS AND STORAGE



COMB. AND DOUBLE SWIVEL END SOCKET WRENCHES, REVERSIBLE GEAR COMB. WRENCHES

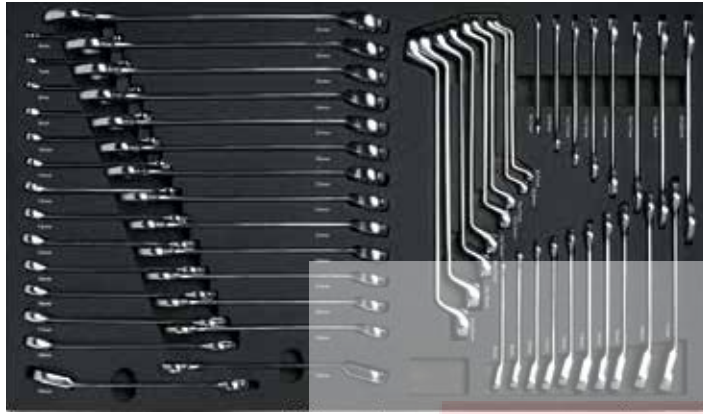

**CONTENT:**

QTY.	DESCRIPTION	SIZE
26	Combination wrenches	2000 6 - 7 - 8 - 9 - 10 - 11 - 12 - 13 - 14 - 15 - 16 - 17 - 18 - 19 - 20 - 21 - 22 - 23 - 24 - 25 - 26 - 27 - 28 - 29 - 30 - 32 mm
12	Reversible gear combination wrenches	2005 8 - 9 - 10 - 11 - 12 - 13 - 14 - 15 - 16 - 17 - 18 - 19 mm
8	Double open end wrenches	2010 6x7 - 8x9 - 10x11 - 12x13 - 14x15 - 16x17 - 18x19 - 20x22 mm
8	Double end offset ring wrenches	2110 6x7 - 8x9 - 10x11 - 12x13 - 14x15 - 16x17 - 18x19 - 20x22 mm

IMPACT DRIVER, ADJUSTABLE WRENCHES, HEXAGONAL KEYS, FILES AND MEASURING TOOLS



**CONTENT:**

QTY.	DESCRIPTION	SIZE
9	Long angled Torx® keys	4131 TX T8 - T10 - T15 - T20 - T25 - T27 - T30 - T40 - T50
9	Long angled ball-point hexagon keys	4105 BP 1,5 - 2 - 2,5 - 3 - 4 - 5 - 6 - 8 - 10 mm
8	Foldable ball-point key set for hex head screws	4195 F5/8 1,5 - 2 - 2,5 - 3 - 4 - 5 - 6 - 8 mm
8	Foldable key set for Torx® screws	4190 FTXS/8 TX T9 - T10 - T15 - T20 - T25 - T27 - T30 - T40
4	Adjustable wrenches	2600 6" - 8" - 10" - 12"
1	Vernier caliper	9200 150 mm
1	Measuring tape	9400 3 mtr.
1	Flat file	3900 200 mm
1	Round file	3901 200 mm
1	Halfround file	3902 200 mm
1	Square file	3903 200 mm
1	Triangular file	3904 200 mm
3	Bits for slotted head screws	4516 5/16" 8 - 10 - 12 mm
4	Bits for Phillips® screws	4516 5/16" ACR PH 2 - 3 - 4
3	Bits for Torx® screws	4516 5/16" TX T40 - T45 - T50 - T55
5	Bits for hex head screws	4516 5/16" H 5 - 6 - 8 - 10 - 12 mm
1	Screwdriver bit socket	4712 1/2" x 5/16"
1	Impact bit driver	4712 1/2 ID

BITS, HAMMERS AND IMPACT TOOLS



**CONTENT:**

QTY.	DESCRIPTION	SIZE
1	Engineers hammer, 300 g	8030 300 g
1	Sledge hammer, 1000 g	8040 1000 g
1	Dead blow hammer, 30 mm	8060 30 mm
6	Pin punches	8200 2 - 3 - 4 - 5 - 6 - 8 mm
5	Taper punches	8205 2 - 3 - 4 - 5 - 6 mm
2	Center punches	8210 sizes 1 - 2
2	Cape chisels	8215 5 - 7 mm
2	Flat cold chisels	8220 12 - 18 mm
1	Magnetic pick-up tool	9000 2,2 kg
1	Magnetic bit holding screwdriver	4043 1/4" M
1	Quick-Release screwdriver bit socket	4714 1/4" QR
1	Screwdriver bit socket	4714 1/4"
1	Socket adaptor	4714 1/4" SQ 25 mm
5	Bits for slotted head screws	4514 1/4" 3,5 - 4,5 - 5,5 - 6,5 - 8 mm
3	Bits for Phillips® screws	4514 1/4" ACR PH 1 - 2 - 3
3	Bits for Pozidriv® screws	4514 1/4" ACR PZ 1 - 2 - 3
7	Bits for Torx® screws	4514 1/4" TX T10 - T15 - T20 - T25 - T27 - T30 - T40
9	Bits for Tamper Resistant® Torx® head screws	4514 1/4" STX T8 - T9 - T10 - T15 - T20 - T25 - T27 - T30 - T40
7	Bits for hex head bore hole screws	4514 1/4" HB 2 - 2,5 - 3 - 4 - 5 - 6 - 8 mm
1	Bits for square head screws	4514 1/4" SQ 2
5	Bits for spanner screws	4514 1/4" SN 4 - 6 - 8 - 10 - 12
4	Bits for Torq-Set® screws	4514 1/4" TS 6 - 8 - 10 mm / 1/4"
3	Bits for XZN screws	4514 1/4" XZN 5 - 6 - 8
4	Bits for Tri-Wing® screws	4514 1/4" TW 2 - 3 - 4 - 5
1	Bits for hooks	4514 1/4" HOOK

PLIERS, CIRCLIPS PLIERS AND CUTTING TOOLS



**CONTENT:**

QTY.	DESCRIPTION	SIZE
1	Combination plier	3001 180 mm
1	Long nose plier	3005 160 mm
1	Bent nose plier	3006 160 mm
1	Diagonal plier	3002 160 mm
1	Water pump plier	3020 250 mm
1	Internal circlip plier, straight	3100 180 mm - Ø19 - 60 mm
1	Internal circlip plier, bent	3105 180 mm - Ø19 - 60 mm
1	External circlip plier, straight	3110 180 mm - Ø19 - 60 mm
1	External circlip plier, bent	3115 180 mm - Ø19 - 60 mm
1	Locking plier, curved jaw, w/wire cutter	3200 180 mm
1	Timmans shears (straight)	3410 250 mm
1	Electronic scissor	3500 140 mm - 3,0 mm
1	Knife	9105 18 mm
1	Junior hacksaw	9210 150 mm
1	Wire stripper	3009 160 mm



# POLAR® ROLLER CABINETS, ASSORTMENTS AND STORAGE



## 1875 S7 TOOL SET - 447 TOOLS

ITEM NO. 1875-0447

**SUITABLE FOR**  
X-LARGE - page 44-45

5704196 020266 55 KG

**447  
TOOLS**



**CONTENT:**

- |  |   |   |  |                            |
|--|---|---|--|----------------------------|
| 1800 Combination wrench set 8 - 19 mm                    | 1817 3/8" Socket wrench set 6 - 22 mm   | 1829 B Screwdriver set for slotted head screws                  | 1837 Adjustable wrenches 6" - 8" - 10" | 1846 Impact accessories    |
| 1801 Combination wrench set 20 - 24 mm                   | 1819 1/2" Socket wrench set 10 - 32 mm  | 1830 C Screwdriver set, PH                                      | 1839 Hammers, chisels and files set    | 1847 Impact driver bit set |
| 1805 A Metric double open end wrench set                 | 1820 1/2" Long sockets 10 - 24 mm   | 1830 B Screwdriver set, PZ                                      | 1840 Impact tool set                   | 1848 Screwdriver set, hex  |
| 1805 B Metric double open end wrench set                 | 1824 1/2" Socket drivers for slot-head, Phillips®, Pozidriv® and hexagonal screws | 1831 A Screwdriver set, TX                                      | 1841 Plier set for circlips 19 - 60 mm | 1849 Screwdriver set       |
| 1807 Reversible ratchet combination wrench set 8 - 19 mm | 1825 1/2" Long socket drivers for hex head screws 5-19 mm                         | 1834 Metric and Torx® hexagon key set                           | 1842 1/2" Impact socket set            |                            |
| 1812 Double swivel end socket wrench set 8 - 19 mm       | 1826 1/2" Long socket drivers for Torx® screws T10 - T50                          | 1835 Plier set with combination-, cutting- and long nose pliers | 1843 Bits set                          |                            |
| 1813 1/4" Socket wrench set 4 - 14 mm                    | 1827 1/2" Ratchet and accessories   | 1836 Plier set with waterpump- and locking pliers               | 1844 Measuring and cutting tool set    |                            |
| 1815 1/4" Long sockets and socket drivers                |   |   | 1845 Measuring and cutting tool set    |                            |

# POLAR® ROLLER CABINETS, ASSORTMENTS AND STORAGE

## 1100 WALLMOUNTED CABINETS

- Perforated panels with round holes Ø 4 mm.
- Surface: Black powder coating.
- Large program in hooks and holders



ITEM NO.	5704196+	H MM	W MM	D MM	KG	
1100-0261	011783	800	600	240	16,5	1

## 1110 TOOL PANELS

- Perforated panels with round holes Ø 4 mm.
- Surface: Black powder coating.
- Large program in hooks and holders

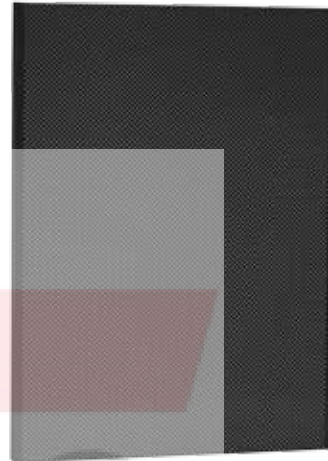

ITEM NO.	5704196+	H MM	W MM	KG	
1110-0305	011806	475	950	4	1
1110-0310	011813	950	950	8	1
1110-0312	011820	750	1050	7	1
1110-0315	011837	950	1450	12	1

## 1100 HOLDER FOR CHISELS

- Holder for 11 tools.
- Surface: Black powder coating.

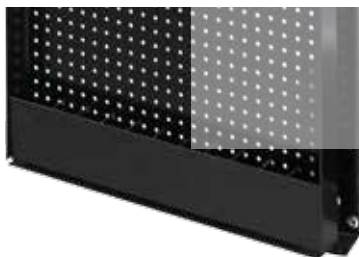

ITEM NO.	5704196+	L MM	H MM	G	
1100-0246	011776	295	57	300	1

## 1110 WALL MOUNTING UNIT

- To be used for tool panel mounting.



ITEM NO.	5704196+	L MM	G	
1110-0324	011844	100	90	1

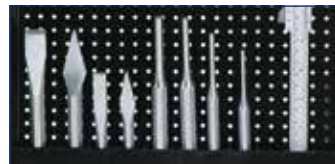
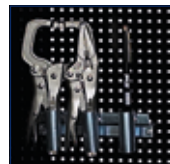



# POLAR® ROLLER CABINETS, ASSORTMENTS AND STORAGE



## TOOL HOLDERS

### 1120 TOOL HOLDERS

- Holder for wrenches and adjustable wrenches etc.

ITEM NO.	5704196+	Ø MM	L MM	G	
1120-0702	011868	5	30	9	1
1120-0703	011875	5	45	10	1
1120-0705	011882	5	100	19	1



### 1120 TOOL HOOK

- Strong bent hook.

ITEM NO.	5704196+	L MM	G	
1120-0726	012018	100	62	1



### 1120 TOOL HOOKS

- Hook for wrenches and adjustable wrenches etc.

ITEM NO.	5704196+	Ø MM	L MM	G	
1120-0704	011882	5	25	9	1
1120-0706	011905	5	30	12	1



### 1120 TOOL HOLDERS

- Holder for sockets.

ITEM NO.	5704196+	Ø	G	
1120-0733	012063	3/8"	11	1
1120-0734	012070	1/2"	15	1
1120-0735	012087	3/4"	29	1



### 1120 TOOL HOOKS

- Hook for heavy tools.

ITEM NO.	5704196+	Ø MM	L MM	G	
1120-0707	011912	6	80	52	1
1120-0708	011929	8	140	95	1
1120-0709	011936	8	200	115	1
1120-0710	011943	6	20	43	1
1120-0711	011950	6	100	58	1



### 1120 TOOL HOOKS

- Double hook for files and hammers etc.

ITEM NO.	5704196+	INT. DIST.	G	
1120-0727	012025	12 mm	25	1
1120-0730	012032	19 mm	28	1
1120-0732	012056	26 mm	30	1



### 1120 TOOL HOOKS

- Bent hook.

ITEM NO.	5704196+	L MM	G	
1120-0721	011998	35	14	1
1120-0722	012001	45	17	1



**polar**

**POLAR®**

### 1120 TOOL HOLDER

▪ Holder for spraycans.



ITEM NO.	5704196+	INT. Ø MM	H MM	G	Icon
1120-0794	012490	80	110	95	1

### 1120 SCREWS



ITEM NO.	5704196+	QTY.	DIMENSION	G	Icon
1120-0796	012469	100	4,8 x 6,5 mm	180	1

### 1125 ASSORTMENTS WITH HOOKS AND HOLDERS

▪ Hooks and holders incl. screws.



ITEM NO.	5704196+	QTY.	G	Icon
1125-0700	012476	65	2,2	1
1125-0702	012483	100	3,0	1





## WORKBENCH

POLAR® workbenches are constructed in a heavy duty version in order to meet your requirements for a complete workstation.

Material: 3 mm sheet steel.

Worktop in 15 mm hard PVC material.



Surface: Black and grey powder coating.

Adjustable height

### 1300 WORKBENCH, 1500 MM

ITEM NO. 1300-1500

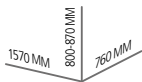

41 KG

5704196 013602

### 1345 PERFORATED TOOL PANEL

ITEM NO. 1345-1500

5704196 013626

HxWxD 590 x 1350 x 15 mm

14 KG

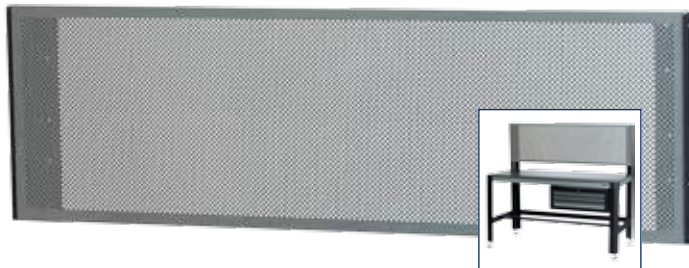

- Large program in hooks and holders.
- Perforated panel with round holes Ø 4 mm.
- Surface: Grey powder coating.

### 1350 3D DRAWER CHEST

ITEM NO. 1350-0003

5704196 013633

HxWxD 270 x 670 x 315 mm

15 KG



- 3 drawers mounted on ball bearing slides.
- All drawers are supplied with oil-proof rubber mats.
- Centralized locking.
- Drawer loading capacity: 30 kg
- 2 drawers: H 48 x B 565 x D 260 mm
- 1 drawer: H 65 x B 565 x D 260 mm
- Surface: Black and grey powder coating.
- Material: 1,2 mm sheet steel casing.

**polar**  
handtools

**polar**  
handtools

## POLAR® ROLLER CABINETS, ASSORTMENTS AND STORAGE

### 1000 5D MINI ROLLER CABINET (EMPTY)

ITEM NO. 1000-3005

5704196 016863

HxWxD 780 x 575 (645) x 340 mm

35 KG

1



- Low model which can be stored under the workbench.
- Worktop in hard PVC material, chemical resistant.
- 5 drawers mounted on ball bearing slides.
- All drawers are supplied with oil-proof rubber mats.
- Centralized locking.
- 2 swivelling wheels with brakes.
- 200 kg static load. Drawer loading capacity: 30 kg
- Oil-proof nylon wheels: Ø 100 mm
- 3 drawers: H 65 x W 470 x D 290 mm
- 2 drawers: H 145 x W 470 x D 290 mm
- Surface: Black and grey powder coating.
- Material: 1,2 mm sheet steel casing.

### 1200 SERVICE CART

ITEM NO. 1200-0003

5704196 013596

HxWxD 1040 x 760 (910) x 490 mm

12 KG

1



- Lightweight construction in aluminium with 3 shelves and handles made of PVC material.
- 4 swivelling wheels - 2 with brakes.
- Shelf loading capacity: 50 kg
- Oil-proof rubber wheels: Ø 100 mm
- 3 shelves: W 700 x D 440 mm





## POLAR® ROLLER CABINETS, ASSORTMENTS AND STORAGE



### 1092 A2 TOOL BOX WITH TOOL ASSORTMENT

ITEM NO. 1091-0066

5704196 018508 HxWxD 240 x 495 x 225 mm 17 KG 1

- TOOL BOX with tool set type 1875 S4.
- 2 drawers mounted on ball bearing slides.
- All drawers are supplied with oil-proff rubber mats.
- Centralized locking.
- 66 tools.

### 1092 A5M ROLLER CABINET WITH TOOL ASSORTMENT

ITEM NO. 1092-0066

5704196 018546 HxWxD 780 x 575 x 340 mm 12 KG 1

- MINI roller cabinet with tool set type 1875 S4.
- Worktop in hard PVC material.
- 5 drawers mounted on ball bearing slides.
- Centralized locking.
- 66 tools.

#### CONTENT S4 TOOL SET - 66 TOOLS:



QTY.	DESCRIPTION	SIZE
18	6-point sockets	5012 1/2" 10-11-12-13-14-15-17-19-20-21-22-23-24-27-30-32mm
1	Ratchet, 72 teeth	5312 1/2"
2	Extensions	5212 1/2" EX 125 - 250 mm
1	Sliding T-handle	5412 1/2" TH
1	Universal joint	5812 1/2" U
4	Screwdrivers for slotted head screws	4000 3 x 75 - 4 x 100 - 5,5 x 125 - 6,5 x 150 mm
3	Screwdrivers for Phillips® screws	4010 PH 1 - PH 2 - PH 3
14	Combination wrenches	2000 8 - 9 - 10 - 11 - 12 - 13 - 14 - 15 - 16 - 17 - 18 - 19 - 21 - 22 mm
1	Combination plier	3001 180 mm
1	Diagonal cutter	3002 160 mm
1	Half-round long nose plier	3005 160 mm

QTY.	DESCRIPTION	SIZE
1	Waterpump plier	3020 250 mm
1	Locking plier	3202 250 mm
1	Electricians scissor	3500 140 mm
9	Long metric hexagon keys	4105 BP 1.5 - 2 - 2.5 - 3 - 4 - 5 - 6 - 8 - 10 mm
1	Mechanics hammer	8030 300 g
1	Taper punch	8205 3 x 120 mm
1	Center punch	8210 2 x 120 mm
1	Cape chisel	8215 5 x 130 mm
1	Flat chisel	8220 12 x 130 mm
1	Pin punch	8200 4 x 150 mm
1	Hacksaw	9210 300 mm



## POLAR® WRENCHES



Polished heads and compact design

# WRENCHES

POLAR® Wrenches are manufactured according to international standards, giving you the professional quality known by POLAR® products. Our wrenches have a perfect fit and ensures great comfort, giving you a slim design, which facilitates working in confined spaces.

- Combination wrenches
- Combination wrenches offset
- Reversible gear combination wrenches
- Double open end wrenches
- Double socket ratchet wrenches
- Double end offset ring wrenches
- Flare nut wrenches
- Double swivel end socket wrenches
- Swivel gear combination wrenches
- Adjustable wrenches



Slim ergonomic profile

Max. torque profile





## POLAR® WRENCHES



### WRENCHES

#### 2000 METRIC COMBINATION WRENCHES

ISO 3318, DIN 3113.

- 12-Point ring angled at 15°. Open end angled at 15°.
- Surface: Satin chrome finish. Material: Chrome-vanadium steel.

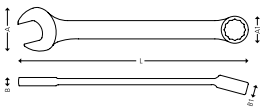

ITEM NO.	5704196+	SIZE MM	A MM	A1 MM	B MM	B1 MM	L MM	G MM	Weight G
2000-0006	000015	6	15,5	10,1	4,0	4,7	105	17	12
2000-0007	000022	7	17,0	11,5	4,0	5,0	115	20	12
2000-0008	000039	8	19,2	12,8	4,5	5,5	125	26	12
2000-0009	000046	9	21,2	14,2	4,7	5,9	135	34	12
2000-0010	000053	10	23,2	15,6	5,0	6,5	145	36	12
2000-0011	000060	11	25,3	16,9	5,4	6,9	155	44	12
2000-0012	000077	12	27,2	18,3	5,5	7,3	165	52	12
2000-0013	000084	13	29,4	19,7	5,9	7,8	175	63	12
2000-0014	000091	14	31,5	21,2	6,2	8,3	185	78	12
2000-0015	000107	15	33,2	22,5	6,4	8,6	195	94	12
2000-0016	000114	16	34,7	24,0	6,7	8,9	205	106	12
2000-0017	000121	17	36,5	25,3	6,9	9,3	215	132	12
2000-0018	000138	18	38,7	26,8	7,2	9,9	225	144	12
2000-0019	000145	19	40,7	28,1	7,4	10,5	235	154	12
2000-0020	000152	20	43,1	29,7	7,7	10,9	245	188	12
2000-0021	000169	21	44,8	31,3	8,1	11,6	255	200	12
2000-0022	000176	22	46,9	32,6	8,2	11,5	265	220	12
2000-0023	000183	23	48,3	34,2	8,4	11,8	275	260	12
2000-0024	000190	24	50,4	35,5	8,7	12,1	285	280	6
2000-0025	000206	25	52,0	36,9	8,9	12,5	295	300	6
2000-0026	000213	26	53,6	38,2	9,2	12,8	305	320	6
2000-0027	000220	27	55,7	39,6	9,4	13,1	315	360	6
2000-0028	000237	28	57,6	40,9	9,7	13,3	325	380	6
2000-0029	000244	29	59,7	42,3	9,9	13,5	335	460	6
2000-0030	000251	30	61,8	43,7	10,1	13,7	345	500	6
2000-0032	000268	32	65,8	46,4	10,4	14,3	365	560	6
2000-0033	000275	33	69,3	48,8	10,7	15,0	380	680	5
2000-0034	000282	34	69,2	48,8	10,7	15,0	380	680	5
2000-0035	000299	35	74,0	53,0	13,5	19,2	410	860	5
2000-0036	000305	36	74,0	53,0	13,5	19,2	410	860	5
2000-0038	000312	38	77,0	56,0	15,0	20,4	430	1000	5
2000-0041	000329	41	84,0	61,0	16,0	21,6	460	1160	5
2000-0046	000336	46	92,0	66,0	17,0	23,0	500	1700	5
2000-0050	000343	50	102,0	73,0	18,0	24,6	540	2120	5
2000-0055	011639	55	118,0	86,0	28,0	21,5	560	2800	5
2000-0060	011646	60	126,0	94,0	30,0	23,5	600	3900	5
2000-0065	011653	65	148,0	108,0	32,0	25,0	680	5800	2
2000-0070	011660	70	148,0	108,0	32,0	25,0	680	5800	2

#### 2090 METRIC COMBINATION WRENCH SET - 6 PCS.

- Supplied in nylon bag.

6  
TOOLS



ITEM NO.	5704196+	QTY.	SIZE MM	Weight G	Volume L
2090-0006	000749	6	2000 10 - 12 - 13 - 14 - 17 - 19 mm	700	1
P2090-0006	016955	1	Empty pouch for 2090-0006	106	1

#### 2090 METRIC COMBINATION WRENCH SET - 12 PCS.

- Supplied in nylon bag.

12  
TOOLS



ITEM NO.	5704196+	QTY.	SIZE MM	Weight G	Volume L
2090-0012	009933	12	2000 8-9-10-11-12-13-14-15-16-17-18-19mm	1258	1
P2090-0012	016962	1	Empty pouch for 2090-0012	164	1





## POLAR® WRENCHES



### 2090 METRIC COMBINATION WRENCH SET - 26 PCS.

■ Supplied in nylon bag.

26  
TOOLS



ITEM NO.	5704196+	QTY.	SIZE MM	G	
2090-0026	000756	26	20006-7-8-9-10-11-12-13-14-15-16-17-18-19-20-21-22-23-24-25-26-27-28-29-30-32 mm	1742	1
P2090-0026	016979	1	Empty pouch for 2090-0026	506	1

### 2000 INCH COMBINATION WRENCHES

ISO 3318, DIN 3113

- 12-Point ring angled at 15°. Open end angled at 15°.
- Surface: Satin chrome finish. Material: Chrome-vanadium steel.



ITEM NO.	5704196+	SIZE "	A MM	A1 MM	B MM	B1 MM	L MM	G	
2000-1008	000350	1/4"	15,5	10,1	4,0	4,7	105	17	12
2000-1010	000367	5/16"	19,2	12,8	4,5	5,5	125	26	12
2000-1012	000374	3/8"	23,2	15,6	5,0	6,5	145	36	12
2000-1014	000381	7/16"	25,3	16,9	5,4	6,9	155	44	12
2000-1016	000398	1/2"	29,4	19,7	5,9	7,8	175	63	12
2000-1018	000404	9/16"	31,5	21,2	6,2	8,3	185	78	12
2000-1020	000411	5/8"	34,7	24,0	6,7	8,9	205	106	12
2000-1022	000428	11/16"	36,5	25,3	6,9	9,3	215	132	12
2000-1024	000435	3/4"	40,7	28,1	7,4	10,5	235	154	12
2000-1026	000442	13/16"	44,8	31,3	8,0	11,3	255	200	12
2000-1028	000459	7/8"	46,9	32,6	8,2	11,5	265	220	12
2000-1030	000466	15/16"	50,4	35,5	8,7	12,1	285	280	6
2000-1032	000473	1"	52,0	36,9	8,9	12,5	295	300	6
2000-1034	000480	1 1/16"	55,7	39,6	9,4	13,1	315	360	6
2000-1036	000497	1 1/8"	59,7	42,3	9,9	13,5	335	460	6
2000-1040	000503	1 1/4"	65,8	46,4	10,4	14,3	365	560	6

### 2090 METRIC COMBINATION WRENCH SET - 12 PCS.

■ Supplied in plastic holder.

12  
TOOLS



ITEM NO.	5704196+	QTY.	SIZE MM	G	
2090-0112	019529	12	8-9-10-11-12-13-14-15-16-17-18-19 mm	1252	1

### 2090 INCH COMBINATION WRENCH SET - 12 PCS.

■ Supplied in nylon bag.

12  
TOOLS



ITEM NO.	5704196+	QTY.	SIZE "	G	
2090-1012	000763	12	2000 1/4 - 5/16 - 3/8 - 7/16 - 1/2 - 9/16 - 5/8 - 11/16 - 3/4 - 13/16 - 7/8 - 1"	1569	1
P2090-1012	016986	1	Empty pouch for 2090-1012	245	1



## POLAR® WRENCHES



### 2005 REVERSIBLE METRIC GEAR COMBINATION WRENCHES

ISO 1711-1, ISO 7738

- Reversible model with 72 teeth and a working angle of 5°.
- 12-Point ring angled at 15°. Open end angled at 15°.
- Surface: Satin chrome finish. Material: Chrome-vanadium steel.

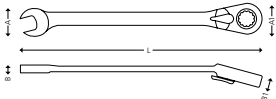

ITEM NO.	5704196+	SIZE MM	A MM	A1 MM	B MM	B1 MM	L MM	G	
2005-0008	013343	8	16,4	16,7	5,5	7,6	139	37	7
2005-0009	013350	9	19,1	19,3	5,2	7,4	149	46	7
2005-0010	013367	10	20,8	21,4	5,4	7,5	160	60	9
2005-0011	013374	11	23,2	22,0	5,9	7,8	164	68	9
2005-0012	013381	12	25,5	23,3	6,4	8,5	170	82	8
2005-0013	013398	13	27,2	25,8	6,5	9,8	178	99	8
2005-0014	013404	14	29,8	27,7	7,2	9,6	188	119	8
2005-0015	013411	15	31,5	29,2	7,2	9,6	199	136	8
2005-0016	013428	16	33,8	30,2	7,3	10,2	207	151	7
2005-0017	013435	17	35,3	33,2	8,3	10,2	223	186	8
2005-0018	013442	18	33,4	33,9	8,6	10,8	234	220	8
2005-0019	013459	19	39,8	34,7	8,8	11,4	224	241	7
2005-0020	013466	20	43,8	38,6	9,4	12,8	273	322	5
2005-0021	013473	21	43,6	37,6	9,5	12,5	274	313	5
2005-0022	013480	22	44,8	40,8	9,9	13,5	286	378	5
2005-0023	013497	23	44,3	40,5	9,5	13,7	285	364	5
2005-0024	013503	24	44,1	40,7	9,8	13,6	286	364	5

### 2010 METRIC DOUBLE OPEN END WRENCHES

ISO 10102, DIN 3110.

- Open end angled at 15°.
- Surface: Satin chrome finish. Material: Chrome-vanadium steel.

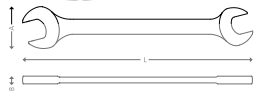

ITEM NO.	5704196+	SIZE MM	A MM	A1 MM	B MM	L MM	G	
2010-0607	017921	6 x 7	15,5	18,0	3,7	123	19	12
2010-0809	017938	8 x 9	19,7	22,1	4,5	140	34	12
2010-1011	017945	10 x 11	24,3	26,5	5,7	156	61	12
2010-1013	017952	10 x 13	28,0	30,2	5,5	172	74	12
2010-1213	017969	12 x 13	28,4	30,1	5,5	172	72	12
2010-1317	017983	13 x 17	32,2	38,0	6,5	195	109	12
2010-1415	017976	14 x 15	32,4	34,4	7,6	190	107	12
2010-1617	017990	16 x 17	36,3	38,2	7,1	204	135	12
2010-1719	018003	17 x 19	40,4	42,3	7,1	221	156	12
2010-1819	018010	18 x 19	40,4	42,3	7,2	221	158	12
2010-1922	018027	19 x 22	44,2	48,1	7,6	237	207	12
2010-2022	018034	20 x 22	44,1	48,2	7,5	237	205	12
2010-2123	018041	21 x 23	45,0	49,9	8,1	247	232	12
2010-2224	018058	22 x 24	46,0	50,1	8,7	247	249	12
2010-2426	018065	24 x 26	50,2	56,1	8,3	255	286	10
2010-2427	018072	24 x 27	51,9	58,1	8,4	263	282	10
2010-2528	018089	25 x 28	53,5	60,0	9,2	279	381	5
2010-2729	018096	27 x 29	56,4	61,6	8,7	283	382	5
2010-3032	018102	30 x 32	64,5	69,2	9,8	298	460	6
2010-3236	018119	32 x 36	69,8	76,0	10,5	350	600	6
2010-3436	018126	34 x 36	69,8	76,0	10,5	350	600	6
2010-3641	018133	36 x 41	76,0	87,0	12,0	380	920	6
2010-4146	018140	41 x 46	86,0	95,0	15,0	415	1300	5
2010-4650	018157	46 x 50	95,0	104,0	16,0	465	1900	5

### 2095 REVERSIBLE GEAR COMBINATION WRENCH SET - 12 PCS.

- Supplied in nylon bag.



ITEM NO.	5704196+	QTY.	SIZE MM	G	
2095-0012	013206	12	2005 8-9-10-11-12-13-14-15-16-17-18-19 mm	1630	1
P2095-0012	016993	1	Empty pouch for 2095-0012	195	1

### 2091 METRIC DOUBLE OPEN END WRENCH SET - 8 PCS.

- Supplied in nylon bag.



ITEM NO.	5704196+	QTY.	SIZE MM	G	
2091-0008	018164	8	2010 6 x 7 - 8 x 9 - 10 x 11 - 12 x 13 - 14 x 15 - 16 x 17 - 18 x 19 - 20 x 22 mm	925	1
P2091-0008	020464	1	Empty pouch for 2091-0008	135	1



## POLAR® WRENCHES

### 2091 METRIC DOUBLE OPEN END WRENCH SET - 12 PCS.

▪ Supplied in nylon bag.



ITEM NO.	5704196+	QTY.	SIZE MM	G	
2091-0012	018171	12	2010 6x7-8x9-10x11x12x13-14x15-16x17-18x19-20x22-21x23-24x27-25x28-30x32 mm	2510	1
P2091-0012	020013	1	Empty pouch for 2091-0012	270	1

### 2095 A/3 ADAPTOR SET FOR GEAR WRENCHES

- The set includes 3 adaptors for 1/4", 3/8" and 1/2" square.
- Socket retaining system with quick release button.
- Surface: Satin chrome finish. Material: Chrome-vanadium steel.



ITEM NO.	5704196+	QTY.	SIZE "/MM	G	
2095-0003	015651	3	1/4" / 10 mm - 3/8" / 13 mm - 1/2" / 19 mm	98	1

### 2070 DOUBLE SOCKET RATCHET WRENCHES

- Reversible model with 32 teeth and double 12-point metric socket.
- Surface: Phosphatised finish. Material: Chrome-vanadium steel.

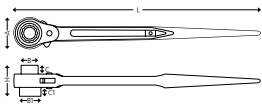

ITEM NO.	5704196+	SIZE MM	MAX. TORQUE NM	BXB1 MM	CXC1 MM	H MM	L MM	G	
2070-1317	019130	13 x 17	137 - 157	18 x 23	8 x 8	44	280	285	2
2070-1922	022932	19 x 22	510 - 589	26 x 29	16 x 16	50	315	460	
2070-1924	019147	19 x 24	510 - 589	26 x 32	16 x 16	55	315	785	2
2070-2730	019154	27 x 30	1570 - 1669	37 x 40	18 x 18	63	450	1325	2
2070-3236	019161	32 x 36	1570 - 1669	43 x 49	21 x 21	67	450	1325	2



### 2100 METRIC COMBINATION WRENCHES OFFSET

- 12-Point ring angled at 70°. Open end angled at 15°.
- Surface: Chrome plated finish, with polished heads  
Material: Chrome-vanadium steel.

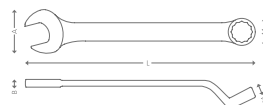

ITEM NO.	5704196+	SIZE MM	A MM	A1 MM	B MM	B1 MM	L MM	G	
2100-0006	005874	6	15,2	10,3	3,9	5,1	102	16	12
2100-0007	005881	7	17,3	11,5	4,1	6,3	112	20	12
2100-0008	005898	8	19,2	13,1	4,3	6,6	122	25	12
2100-0009	005904	9	21,1	14,0	4,8	7,3	131	33	12
2100-0010	005911	10	23,1	15,7	4,8	8,2	140	41	12
2100-0011	005928	11	25,0	17,0	5,3	8,4	150	50	12
2100-0012	005935	12	26,4	18,7	5,4	9,0	160	58	12
2100-0013	005942	13	29,2	21,1	5,5	9,5	170	74	6
2100-0014	005959	14	31,4	21,6	5,8	9,7	180	88	6
2100-0015	005966	15	33,1	22,9	6,2	9,7	190	103	6
2100-0016	005973	16	34,8	24,3	6,0	10,5	200	116	6
2100-0017	005980	17	36,3	25,2	6,5	11,5	210	135	6
2100-0018	005997	18	38,7	27,3	6,7	13,0	220	155	6
2100-0019	006000	19	40,4	28,3	7,2	13,4	230	184	6
2100-0021	006017	21	46,6	30,8	7,8	14,8	260	247	6
2100-0022	006024	22	46,6	30,8	7,8	14,8	260	247	6
2100-0024	006031	24	50,4	34,4	8,3	15,2	280	311	6
2100-0027	006048	27	55,3	38,4	8,5	16,2	310	390	6
2100-0030	006055	30	61,0	41,7	9,2	18,2	340	500	6
2100-0032	006062	32	65,5	44,5	10,1	19,5	360	621	6





## POLAR® WRENCHES



### 2110 METRIC DOUBLE END OFFSET RING WRENCHES

ISO 10104, DIN 838.

- 12-Point ring angled at 70°.
- Surface: Satin chrome finish. Material: Chrome-vanadium steel.

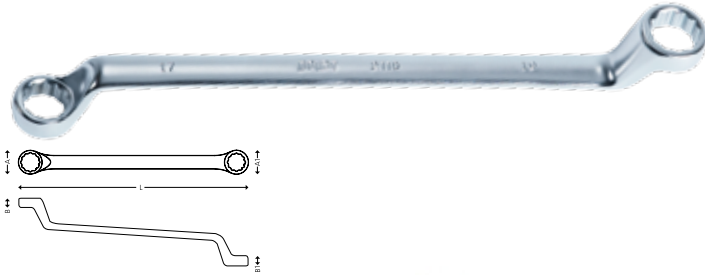

ITEM NO.	5704196+	SIZE MM	A MM	A1 MM	B MM	B1 MM	L MM	G MM	Weight G	Icon
2110-0607	018225	6 x 7	10,7	12,2	6,0	6,5	168	45	12	
2110-0809	018232	8 x 9	13,6	15,1	7,0	7,5	183	60	12	
2110-0810	018249	8 x 10	13,6	15,1	7,0	7,5	183	60	12	
2110-1011	018256	10 x 11	16,6	18,0	8,0	9,0	198	90	12	
2110-1213	018263	12 x 13	19,5	20,9	9,0	9,5	217	118	12	
2110-1415	018270	14 x 15	22,4	23,7	10,0	10,5	239	160	12	
2110-1617	018287	16 x 17	25,3	26,7	11,0	11,3	260	185	6	
2110-1719	018294	17 x 19	28,2	29,7	11,6	11,9	292	210	6	
2110-1819	018300	18 x 19	28,2	29,7	11,6	11,9	292	210	6	
2110-1922	018317	19 x 22	31,1	34,0	12,2	12,9	318	320	6	
2110-2022	018324	20 x 22	31,1	34,0	12,2	12,9	318	320	6	
2110-2123	018331	21 x 23	34,0	36,9	12,5	13,2	330	390	6	
2110-2224	018348	22 x 24	34,0	36,9	12,5	13,2	330	390	6	
2110-2426	018355	24 x 26	36,9	41,4	13,5	14,4	345	500	6	
2110-2427	018362	24 x 27	36,9	41,4	13,5	14,4	345	500	6	
2110-2528	018379	25 x 28	40,4	43,8	13,8	14,7	355	520	6	
2110-3032	018386	30 x 32	45,5	48,5	15,4	16,0	370	670	5	
2110-3641	018393	36 x 41	53,5	62,0	18,0	20,0	451	1130	4	
2110-4650	018409	46 x 50	70,0	76,0	21,0	23,5	526	1820	2	

### 2195 METRIC DOUBLE END OFFSET RING WRENCH SET - 8 PCS.

- Supplied in nylon bag.



8  
TOOLS

ITEM NO.	5704196+	QTY.	SIZE MM	Weight G	Icon
2195-0008	018416	8	2110 6 x 7 - 8 x 9 - 10 x 11 - 12 x 13 - 14 x 15 - 16 x 17 - 18 x 19 - 20 x 22 mm	1410	1
P2195-0008	027098	1	Empty pouch for 2195-0008	183	1

### 2195 METRIC DOUBLE END OFFSET RING WRENCH SET - 12 PCS.

- Supplied in nylon bag.



12  
TOOLS

ITEM NO.	5704196+	QTY.	SIZE MM	Weight G	Icon
2195-0012	018423	12	2110 6x7-8x9-10x11-12x13-14x15-16x17-18x19-20x22-21x23-24x27-25x28-30x32 mm	3650	1
P2195-0012	020020	1	Empty pouch for 2195-0012	343	1





## POLAR® WRENCHES



### 2200 METRIC FLARE NUT WRENCHES

DIN 3118.

- Open ring angled at 15°. Head angled at 15°.
- Hexagonal profile up to size 12x14 mm and bihexagonal profile for larger sizes.
- Surface: Satin chrome finish. Material: Chrome-vanadium steel.

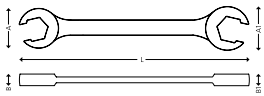

ITEM NO.	5704196+	SIZE MM	A MM	A1 MM	B MM	B1 MM	L MM	G	
2200-0810	017242	8 x 10	18,4	20,8	7,0	8,5	145	47	12
2200-0911	017259	9 x 11	20,8	22,6	8,5	9,0	152	60	12
2200-1113	017266	11 x 13	22,6	25,0	9,0	10,5	165	78	12
2200-1214	017273	12 x 14	25,0	27,4	9,5	11,0	178	120	6
2200-1719	017280	17 x 19	30,0	32,5	12,0	14,0	210	180	6
2200-1922	017297	19 x 22	32,5	38,0	14,0	16,0	233	240	6
2200-2224	017303	22 x 24	38,0	41,0	16,0	17,0	252	300	6
2200-2427	017310	24 x 27	41,0	45,0	17,0	18,0	265	350	6
2200-3032	017327	30 x 32	48,5	51,0	21,0	23,0	285	470	6
2200-3641	017334	36 x 41	58,0	65,0	25,0	27,0	350	820	6

### 2400 METRIC DOUBLE SWIVEL END SOCKET WRENCHES

ISO 1711-1, DIN 899

- Double ended wrenches with 12-Point sockets. Spring washer inside the joints.
- Surface: Chrome plated finish with polished heads. Material: Chrome-vanadium steel.

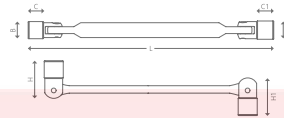
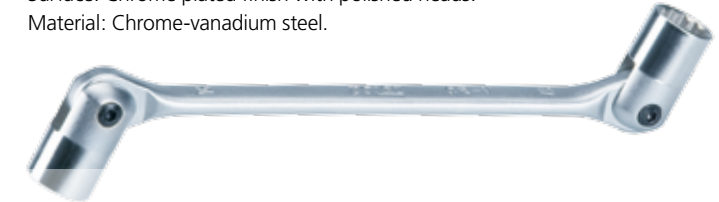

ITEM NO.	5704196+	SIZE MM	B X B1 MM	C X C1 MM	H X H1 MM	L MM	G	
2400-0809	006222	8 x 9	12,9 x 13,7	7,5 x 7,5	16,0 x 16,8	180	80	5
2400-1011	006239	10 x 11	14,7 x 15,8	10,0 x 10,0	18,8 x 19,2	199	106	5
2400-1213	006246	12 x 13	17,6 x 18,7	13,2 x 11,4	23,0 x 22,5	219	163	5
2400-1415	006253	14 x 15	19,6 x 21,6	13,9 x 14,3	24,0 x 25,4	240	231	5
2400-1617	006260	16 x 17	23,7 x 23,7	13,7 x 14,3	29,2 x 29,2	264	333	5
2400-1819	006277	18 x 19	25,7 x 25,7	15,9 x 15,2	29,2 x 29,2	274	400	5
2400-2022	006284	20 x 22	29,7 x 32,8	21,8 x 20,8	35,6 x 40,5	303	516	5
2400-2123	006291	21 x 23	29,7 x 33,9	22,1 x 21,1	35,4 x 39,9	303	555	12

### 2290 METRIC FLARE NUT WRENCH SET

- Supplied in nylon bag.



ITEM NO.	5704196+	QTY.	SIZE MM	G	
2290-0007	017341	7	2200 8x10-9x11-11x13-12x14-17x19-19x22-24x27mm	1240	1
P2290-0007	020457	1	Empty pouch for 2290-0007		1

### 2490 DOUBLE SWIVEL END SOCKET WRENCH SET

- Supplied in nylon bag.



ITEM NO.	5704196+	QTY.	SIZE MM	G	
2490-0006	000794	6	2400 8x9-10x11-12x13-14x15-16x17-18x19mm	1409	1
P2490-0006	017006	1	Empty pouch for 2490-0006	112	1



## 2405 METRIC SWIVEL GEAR COMBINATION WRENCHES

ISO 1711-1.

- 180° swivel head with 72 teeth and a working angle of 5°.
- Open end angled at 15°.
- Surface: Satin chrome finish. Material: Chrome-vanadium steel.

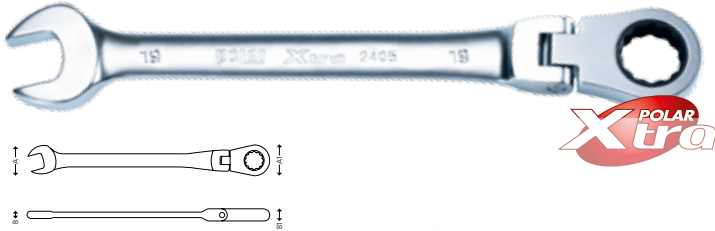

ITEM NO.	5704196+	SIZE MM	A MM	A1 MM	B MM	B1 MM	L MM	G G	
2405-0008	013220	8	17,2	17,2	5,3	7,3	142	47	10
2405-0009	013237	9	19,1	20,4	5,1	7,3	153	57	13
2405-0010	013244	10	21,2	21,0	6,0	7,6	161	73	10
2405-0011	013251	11	23,3	22,6	6,5	7,9	167	85	10
2405-0012	013268	12	25,6	23,4	6,5	8,5	172	100	10
2405-0013	013275	13	26,8	25,7	7,3	9,6	182	124	11
2405-0014	013282	14	29,8	27,7	7,6	9,5	193	141	11
2405-0015	013299	15	30,7	30,0	7,3	9,9	201	151	9
2405-0016	013305	16	33,7	30,2	7,6	10,4	212	179	9
2405-0017	013312	17	35,8	32,7	8,7	10,2	225	211	10
2405-0018	013329	18	37,7	32,3	8,7	10,8	233	242	7
2405-0019	013336	19	39,5	35,2	9,1	11,5	247	272	7

## 2495 SWIVEL GEAR COMBINATION WRENCH SET

- Supplied in nylon bag.

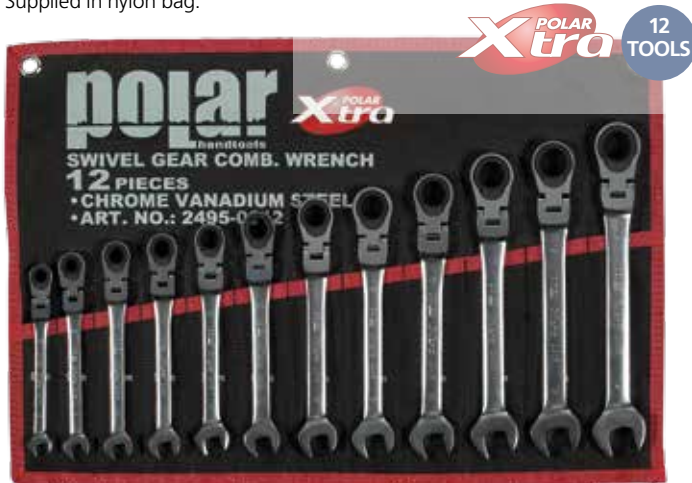

ITEM NO.	5704196+	QTY.	SIZE MM	G G	
2495-0012	013213	12	2405-8-9-10-11-12-13-14-15-16-17-18-19mm	1840	1
P2495-0012	017020	1	Empty pouch for 2495-0012	189	1





## POLAR® WRENCHES

### ADJUSTABLE WRENCHES

#### 2600 ADJUSTABLE WRENCHES

ISO 6787, DIN 3117

- Grinded head tip and 15° angel. Scale in mm. Left knurling.
  - Surface: Phosphatised finish with polished head.
- Material: Chrome-vanadium steel.

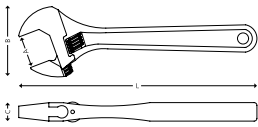

ITEM NO.	5704196+	L MM	L" MM	A MM	B MM	C MM	G		
2600-0004	006307	110	4"	17	35,4	4,6	58	10	
2600-0006	006314	150	6"	23	50,3	6,2	120	10	
2600-0008	006321	200	8"	28	63,3	6,9	240	5	
2600-0010	006338	250	10"	32	73,8	8,1	400	5	
2600-0012	006345	300	12"	38	83,6	9,4	650	5	
2600-0015	006352	375	15"	51	109	10,5	1225	4	
2600-0018	006369	450	18"	61	128,2	10,0	1740	5	
2600-0024	006376	600	24"	70	148	12,4	3700	1	

#### 2602 ADJUSTABLE WRENCHES - EXTRA WIDE OPENING

ISO 6787, DIN 3117

- Grinded head tip and 15° angel. Scale in mm.
  - Ergonomic rubbercoated handle. Left knurling.
  - Surface: Phosphatised finish with polished head.
- Material: Chrome-vanadium steel.

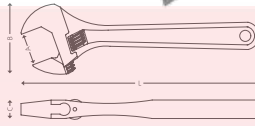

ITEM NO.	5704196+	L MM	L" MM	A MM	B MM	C MM	G		
2602-0006	018812	150	6"	35	65	3	125	10	
2602-0008	018829	200	8"	40	70	4,6	255	5	
2602-0010	018836	250	10"	50	90	6	505	5	

#### 2690 ADJUSTABLE WRENCH SET

- Supplied in nylon bag.



ITEM NO.	5704196+	QTY.	SIZE MM/"	G	
2690-0003	018577	3	2600 150 mm / 6" - 200 mm / 8" - 250 mm / 10"	900	1
P2690-0003	017105	1	Empty pouch for 2690-0003	102	1

#### 2610 GATOR ADJUSTABLE WRENCH

ISO 6787, DIN 3117

- "Alligator"-jaw for use on pipes and rounded fasteners giving a sure grip.
  - Grinded head tip and 15° angel.
  - Scale in mm. Left knurling.
  - Surface: Phosphatised finish with polished head.
- Material: Chrome-vanadium steel.

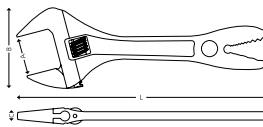

ITEM NO.	5704196+	L MM	L" MM	A MM	B MM	C MM	G		
2610-0008	026381	200	8	32	65	5,5	232	1	

## POLAR® TORQUE WRENCHES



# TORQUE WRENCHES

POLAR® offers a large selection of digital and click-type torque wrenches, to help you get the job done right the first time. Our range of digital torque tools, with easy-to-use push buttons, precisely measures torque applied to fasteners.

- Click-type torque wrenches
- Digital torque wrenches
- Digital torque wrenches with angle measurements
- Digital torque bit drivers
- Digital torque screwdrivers
- Digital torque and angle adapters
- Digital angle meter with magnet





## POLAR® TORQUE WRENCHES

### 7100 TORQUE WRENCHES

ISO 6789, DIN 3122, EN 26789

- Adjustable torque wrench with reversible ratchet.
- Angle indication printed on ratchet head for tightenings with angle control.
- Precision:  $\pm 4\%$ .
- Click-signal on reaching preset torque value.
- Supplied with calibration certificate.
- Wrench is supplied in protective plastic case.



ITEM NO.	5704196+	CAPACITY NM	INCREMENTS NM	■	L MM	G	■
7114-0020	018720	4-20	0,1	1/4"	325	650	1
7138-0060	018737	10-60	0,5	3/8"	335	750	1
7138-0120	018744	20-120	1	3/8"	445	1250	1
7112-0200	018751	40-200	1	1/2"	510	1550	1
7112-0340	018768	60-340	2	1/2"	615	1750	1
7134-0600	018775	100-600	5	3/4"	1050	4950	1
7134-1000	018782	200-1000	5	3/4"	1240	6000	1

### 7300 B DIGITAL TORQUE WRENCHES WITH INTERCHANGEABLE HEADS

ISO 6789, DIN 3122, EN 26789

- Digital torque wrench with reversible 52 teeth ratchet, for both clockwise and counterclockwise operation.
- Accuracy:  $\pm 2\%$  (CW) /  $\pm 3\%$  (CCW) from 20% to 100% of full scale.
- Two operation modes: Track (shows actual torque applied) and Peak (shows maximum reached torque).
- 4 Torque units: Nm, kg-cm, in-lb and ft-lb.
- Acoustic and green/red LED signal at preset torque value.
- Memory function with 9 preset torque values and 50 measurements.
- Battery life (continuous operation): 110 hrs.
- Operating temperature:  $-10^{\circ}\text{C} \sim 60^{\circ}\text{C}$ .
- Storage temperature:  $-20^{\circ}\text{C} \sim 70^{\circ}\text{C}$ .
- Comfortable, non-slip grip handle.
- Humidity: Up to 90% non-condensing.
- Supplied with test certificate, batteries and storage case.



### 7300 A DIGITAL TORQUE WRENCHES

ISO 6789, DIN 3122, EN 26789

- Digital torque wrench with reversible 36 teeth ratchet, for both clockwise and counterclockwise operation.
- Accuracy:  $\pm 2\%$  (CW) /  $\pm 3\%$  (CCW) from 20% to 100% of full scale
- Two operation modes: Track (shows actual torque applied) and Peak (shows maximum reached torque).
- 4 Torque units: Nm, kg-cm, in-lb and ft-lb.
- Acoustic and green/red LED signal at preset torque value.
- Memory function with 9 preset torque values and 50 measurements.
- Battery life (continuous operation): 110 hrs.
- Operating temperature:  $-10^{\circ}\text{C} \sim 60^{\circ}\text{C}$ .
- Storage temperature:  $-20^{\circ}\text{C} \sim 70^{\circ}\text{C}$ .
- Comfortable, non-slip grip handle.
- Humidity: Up to 90% non-condensing.
- Supplied with test certificate, batteries and storage case.



ITEM NO.	5704196+	CAPACITY NM	INCREMENTS NM	■	L MM	G	■
7314-1030	022055	1,5-30	0,01	1/4"	390	727	1
7338-1135	022062	6,8-135	0,1	3/8"	415	898	1
7312-1200	022078	10-200	0,1	1/2"	530	1333	1
7312-1340	022086	17-340	0,1	1/2"	650	1508	1

ITEM NO.	5704196+	CAPACITY NM	INCREMENTS NM	INSERT SIZE (W X H MM)	■	L MM	G	■
7314-2030	022215	1,5-30	0,01	15,3-306,1	1/4"	388	768	1
7338-2135	022222	6,8-135	0,1	69-1378	3/8"	408	936	1
7312-2200	022239	10-200	0,1	102-2041	1/2"	518	1385	1
7312-2340	022246	17-340	0,1	173-3469	1/2"	638	1555	1





## POLAR® TORQUE WRENCHES



### 7400 DIGITAL TORQUE WRENCHES WITH ANGLE MEASUREMENT

ISO 6789, DIN 3122, EN 26789

- Digital torque wrench with reversible 36 teeth ratchet, for both clockwise and counterclockwise operation.
- Perform torque and angle thightnings in a single-step operation.
- Accuracy:  $\pm 2\%$  (CW) /  $\pm 3\%$  (CCW) from 20% to 100% of full scale and  $\pm 2\%$  for 90° rotation.
- Operation modes: Track (shows actual torque applied), Peak (shows maximum reached torque) and Angle.
- 5 measuring units: Nm, kg-cm, in-lb, ft-lb and angle.
- Acoustic and green/red LED signal at preset torque value.
- Memory function with 9 preset torque values and 50 measurements.
- Battery life (continuous operation): 110 hrs.
- Operating temperature: -10°C ~ 60°C.
- Storage temperature: -20°C ~ 70°C.
- Comfortable, non-slip grip handle.
- Humidity: Up to 90% non-condensing.
- Supplied with test certificate, batteries and storage case.



ITEM NO.	5704196+	CAPACITY NM	INCREMENTS NM	■	L MM	⚖ G	📦
7414-0030	022017	1,5-30	0,01	1/4"	390	729	1
7438-0135	022024	6,8-135	0,1	3/8"	415	901	1
7412-0200	022031	10-200	0,1	1/2"	530	1338	1
7412-0340	022048	17-340	0,1	1/2"	650	1509	1

### 7614 1/4" DIGITAL MINI TORQUE WRENCH

ISO 6789, EN 26789

- Digital torque wrench with 60 teeth reversible ratchet bit holder, for both clockwise and counterclockwise operation.
- Drivers accept all standard 1/4" hex screwdriver bits.
- Accuracy:  $\pm 3\%$  (CW) /  $\pm 4\%$  (CCW) from 20% to 100% of full scale.
- Two operation modes: Track (shows actual torque applied) and Peak (shows maximum reached torque).
- 4 Torque units: Nm, kg-cm, in-lb and ft-lb.
- Acoustic and green/red LED signal at preset torque value.
- Battery life (continuous operation): 55 hrs.
- Operating temperature: -10°C ~ 60°C.
- Storage temperature: -20°C ~ 70°C.
- Comfortable, non-slip grip handle.
- Humidity: Up to 90% non-condensing.
- Supplied with test certificate, batteries and storage case.



ITEM NO.	5704196+	CAPACITY NM	INCREMENTS NM	INSERT SIZE (WXHMM)	L MM	⚖ G	📦
7614-0020	022123	1-20	0,01	1/4"	207	167	1

### 7638 3/8" DIGITAL MINI TORQUE WRENCH

ISO 6789, DIN 3122, EN 26789

- Digital torque wrench with reversible 60 teeth ratchet, for both clockwise and counterclockwise operation.
- Accuracy:  $\pm 3\%$  (CW) /  $\pm 4\%$  (CCW) from 20% to 100% of full scale.
- Two operation modes: Track (shows actual torque applied) and Peak (shows maximum reached torque).
- 4 Torque units: Nm, kg-cm, in-lb and ft-lb.
- Acoustic and green/red LED signal at preset torque value.
- Battery life (continuous operation): 55 hrs.
- Operating temperature: -10°C ~ 60°C.
- Storage temperature: -20°C ~ 70°C.
- Comfortable, non-slip grip handle.
- Humidity: Up to 90% non-condensing.
- Supplied with test certificate, batteries and storage case.

ITEM NO.	5704196+	CAPACITY NM	INCREMENTS NM	■	L MM	⚖ G	📦
7638-0085	022147	4,25-85	0,01	3/8"	239	387	1





## POLAR® TORQUE WRENCHES



### 7614 1/4" BICYCLE TOOL KIT

ITEM NO. 7690-1409

- Avoid overload when working on bicycle frames.
- Ideal for every bike enthusiast as well as professionals.
- Tool set supplied in plastic storage case with digital torque wrench and bits.
- *Technical information refer to item no. 7614 (page 95).*

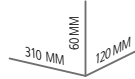

618 G

5704196 022130

1

**CONTENT:**

QTY.	DESCRIPTION	SIZE
1	Digital torque wrench	7614 1-20 Nm - 1/4" bit driver
6	Bits for hex head screws	4514 1/4" H 2 - 2,5 - 3 - 4 - 5 - 6 mm
1	Bits for Torx® head screws	4514 1/4" TX T25
1	Bits for Phillips® screws	4514 1/4" PH2



### 7690 3/8" BICYCLE TOOL KIT

ITEM NO. 7690-3820

- Avoid overload when working on bicycle frames.
- Ideal for every bike enthusiast as well as professionals.
- Tool set supplied in plastic storage case with digital torque wrench and bits.
- *Technical information refer to item no. 7638 (page 95).*

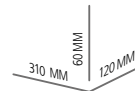

1133 G

5704196 022154

1

**CONTENT:**

QTY.	DESCRIPTION	SIZE
1	Digital Torque Wrench	7638 4.25-85 Nm - 3/8" Square
1	Screwdriver bit socket	4738 3/8"
8	6-point sockets	5038 3/8" 8 - 9 - 10 - 11 - 12 - 13 - 14 - 15 mm
6	Bits for hex head screws	4514 1/4" H 3 - 4 - 5 - 6 - 8 - 10 mm
3	Bits for Torx® head screws	4514 1/4" TX T25 - T30 - T40
1	Bits for Phillips® screws	4514 1/4" PH 2







## POLAR® TORQUE WRENCHES



### 7514 A DIGITAL SCREWDRIVER

ISO 6789, EN 26789

- Digital torque screwdriver with quick-release bit holder, for both clockwise and counterclockwise operation.
- Drivers accept all standard 1/4" hex screwdriver bits.
- Accuracy:  $\pm 3\%$  (CW) /  $\pm 4\%$  (CCW) from 20% to 100% of full scale.
- Two operation modes: Track (shows actual torque applied) and Peak (shows maximum reached torque).
- 3 Torque units: N-cm, kg-cm and in-lb.
- Acoustic and green/red LED signal at preset torque value.
- Memory function with 9 preset torque values and 50 measurements.
- Battery life (continuous operation): 12 hrs.
- Operating temperature:  $-10^{\circ}\text{C} \sim 60^{\circ}\text{C}$ .
- Storage temperature:  $-20^{\circ}\text{C} \sim 70^{\circ}\text{C}$ .
- Comfortable, non-slip grip handle.
- Humidity: Up to 90% non-condensing.
- Supplied with test certificate, batteries and storage case.

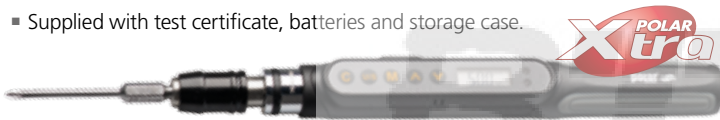

ITEM NO.	5704196+	CAPACITY NM	INCREMENTS NM		L MM	G	
7514-0050	022093	5,0-50	0,1	1/4"	193	142	1

### 7700 DIGITAL TORQUE AND ANGLE ADAPTERS

ISO-6789

- Digital torque and angle adapter, for both clockwise and counterclockwise operation.
- Perform torque and angle tightenings in a single-step operation, using any tightening tool.
- The adapter can be used for verifying any mechanical torque wrench accuracy.
- Accuracy:  $\pm 3\%$  from 20% to 100% of full scale and  $\pm 2\%$  for  $90^{\circ}$  rotation.
- Operation modes: Track (shows actual torque applied), Peak (shows maximum reached torque) and Angle.
- 5 measuring units: Nm, kg-cm, in-lb, ft-lb and angle.
- Acoustic and green/red LED signal at preset torque value.
- Memory function with 9 preset torque values and 50 measurements.
- Battery life (continuous operation): 110 hrs.
- Operating temperature:  $-10^{\circ}\text{C} \sim 60^{\circ}\text{C}$ . Storage temperature:  $-20^{\circ}\text{C} \sim 70^{\circ}\text{C}$ .
- Humidity: Up to 90% non-condensing.
- Supplied with test certificate, batteries and storage case.



ITEM NO.	5704196+	CAPACITY NM	INCREMENTS NM		SIZE MM	G	
7714-0030	022178	1,5-30	0,01	1/4"	86x85x60	163	1
7738-0135	022185	6,8-135	0,1	3/8"	85x85x75	216	1
7712-0200	022192	10-200	0,1	1/2"	85x85x80	240	1
7712-0340	022208	17-340	0,1	1/2"	85x85x80	240	1

### 7514 B/C DIGITAL SCREWDRIVERS

ISO 6789, EN 26789

- Digital torque screwdriver with quick-release bit holder, for both clockwise and counterclockwise operation.
- Drivers accept all standard 1/4" hex screwdriver bits.
- Accuracy:  $\pm 2.5\%$  (CW) /  $\pm 3.5\%$  (CCW) from 20% to 100% of full scale.
- Two operation modes: Track (shows actual torque applied) and Peak (shows maximum reached torque).
- 3 Torque units: N-cm, kg-cm and in-lb.
- Acoustic and green/red LED signal at preset torque value.
- Memory function with 9 preset torque values and 50 measurements.
- Battery life (continuous operation): 55 hrs.
- Operating temperature:  $-10^{\circ}\text{C} \sim 60^{\circ}\text{C}$ .
- Storage temperature:  $-20^{\circ}\text{C} \sim 70^{\circ}\text{C}$ .
- Comfortable, non-slip grip handle.
- Humidity: Up to 90% non-condensing.
- Supplied with test certificate, batteries and storage case.



ITEM NO.	5704196+	CAPACITY NM	INCREMENTS NM		L MM	G	
7514-0200	022109	10-200	0,1	1/4"	203	179	1
7514-0400	022116	20-400	0,1	1/4"	203	179	1





## POLAR® TORQUE WRENCHES

### 7700 A DIGITAL ANGLE METER WITH MAGNET

- Digital angle meter for both clockwise and counter-clockwise operation.
- Built-in magnet for easily fastening to any tightening tool.
- Accuracy:  $\pm 2\%$  for 90° rotation.
- Acoustic and green/red LED signal at preset angle value.
- Memory function with 9 preset angle values and 50 measurements.
- Battery life (continuous operation): 24 hrs.
- Operating temperature: -10°C ~ 60°C.
- Storage temperature: -20°C ~ 70°C.
- Humidity: Up to 90% non-condensing.
- Supplied with test certificate, batteries and storage case.



ITEM NO.	5704196+	SCALE	INCREMENTS	RESOLUTION	DISPLAY RANGE	SIZE MM	G	
7700-0001	022161	1-360°	1°	0,1°	1-999°	58x58x41	72	1

### 7801 BOX END METRIC INSERTS

- 9 x 12 mm
- Surface: Chrome plated finish.
- Material: Chrome-vanadium steel

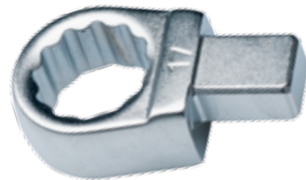
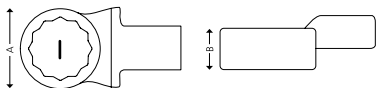

ITEM NO.	5704196+	SIZE mm	A MM	B MM	G	
7801-0007	022413	7	20	8	39	1
7801-0008	022420	8	20	8	39	1
7801-0010	022437	10	20	8	41	1
7801-0011	022444	11	20	8	43	1
7801-0012	022451	12	22	12	53	1
7801-0013	022468	13	22	12	51	1
7801-0014	022475	14	24	12	55	1
7801-0015	022482	15	25	13	56	1
7801-0016	022499	16	27	13	58	1
7801-0017	022505	17	28	13	60	1
7801-0018	022512	18	29	13	61	1
7801-0019	022529	19	31	13	65	1
7801-0021	022536	21	34	15	71	1
7801-0022	022543	22	35	15	72	1

### 7803 BOX END METRIC INSERTS

- 14 x 18 mm
- Surface: Chrome plated finish.
- Material: Chrome-vanadium steel

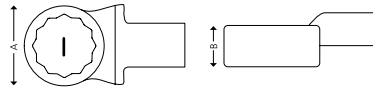

ITEM NO.	5704196+	SIZE MM	A MM	B MM	G	
7803-0013	022727	13	30	12	129	1
7803-0014	022734	14	30	12	129	1
7803-0015	022741	15	30	12	129	1
7803-0016	022758	16	31	12	130	1
7803-0017	022765	17	31	13	134	1
7803-0018	022772	18	31	13	139	1
7803-0019	022789	19	31	12	140	1
7803-0021	022796	21	33	15	152	1
7803-0022	022802	22	35	15	156	1
7803-0024	022819	24	38	15	156	1
7803-0027	022826	27	41	18	200	1
7803-0030	022833	30	45	18	204	1
7803-0032	022840	32	48	18	202	1
7803-0034	022857	34	51	19	223	1
7803-0036	022864	36	53	19	218	1
7803-0041	022871	41	60	19	228	1

### 7800 OPEN END METRIC INSERTS

- 9 x 12 mm
- Surface: Chrome plated finish.
- Material: Chrome-vanadium steel

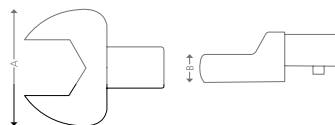

ITEM NO.	5704196+	SIZE MM	A MM	B MM	G	
7800-0007	022284	7	21	6	39	1
7800-0008	022291	8	22	6	39	1
7800-0009	022307	9	23	6	39	1
7800-0010	022314	10	25	6	41	1
7800-0011	022321	11	26	6	43	1
7800-0012	022338	12	28	6	39	1
7800-0013	022345	13	29	6	44	1
7800-0014	022352	14	31	8	54	1
7800-0015	022369	15	33	8	58	1
7800-0016	022376	16	36	8	61	1
7800-0017	022383	17	38	8	59	1
7800-0018	022390	18	39	8	64	1
7800-0019	022406	19	42	8	64	1



## 7802 OPEN END METRIC INSERTS

- 14 x 18 mm
- Surface: Chrome plated finish.
- Material: Chrome-vanadium steel

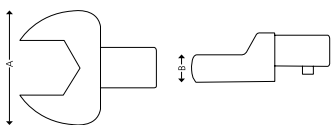

ITEM NO.	5704196+	SIZE MM	A MM	B MM	⚖️ G	📦
7802-0013	022550	13	30	7	116	1
7802-0014	022567	14	32	7	119	1
7802-0015	022574	15	34	7	116	1
7802-0016	022581	16	36	7	127	1
7802-0017	022598	17	37	9	139	1
7802-0018	022604	18	39	9	137	1
7802-0019	022611	19	41	9	139	1
7802-0021	022628	21	45	12	158	1
7802-0022	022635	22	47	12	163	1
7802-0024	022642	24	51	12	170	1
7802-0027	022659	27	59	14	233	1
7802-0030	022666	30	63	14	245	1
7802-0032	022673	32	65	14	245	1
7802-0034	022680	34	66	14	246	1
7802-0036	022697	36	67	14	239	1
7802-0038	022703	38	66	14	224	1
7802-0041	022710	41	82	14	319	1

## 7800 RATCHET INSERTS

- Reversible model with 52 teeth.
- Surface: Chrome plated finish.
- Material: Chrome-vanadium steel

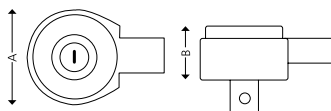

ITEM NO.	5704196+	INSERT SIZE (W X H MM)	MAX. TORQUE Nm	A MM	B MM	⚖️ G	📦
7814-0912	022253	1/4" 12x9	30	25	17	69	1
7838-0912	022260	3/8" 12x9	135	35	23	143	1
7812-1418	022277	1/2" 18x14	340	43	29	316	1





**POLAR®**  
PLIERS



# PLIERS

*POLAR® pliers give you control and comfort. The quality forged steel ensures strength and durability.*

*The handles are designed to offer increased leverage and power.*

- Pliers
- Insulated pliers
- Circlip pliers
- Locking pliers
- Scissors
- Files

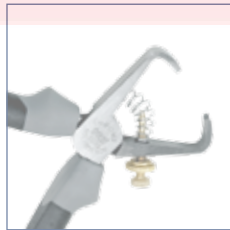



PLIERS

**3001 COMBINATION PLIER**

ISO 5746, DIN 5746

- Model with cutter for piano wire (200 kg/mm<sup>2</sup>) and knurled gripping surface.
  - Ergonomic handles with wide palm support.
  - Surface: Phosphatised finish with polished head.
- Material: Chrome-molybdenum steel.

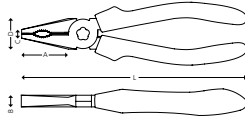

ITEM NO.	5704196+	L MM	Ø MAX. MM	A MM	B MM	C MM	D MM	G G	
3001-0180	007601	180	1,8	38,0	10,0	6,0	26,5	231	6

**3005 HALF-ROUND LONG NOSE PLIERS WITH STRAIGHT JAWS**

ISO 5745, DIN 5745

- Model with cutter for hard wire (160 kg/mm<sup>2</sup>) and knurled gripping surface.
  - Ergonomic handles with wide palm support.
  - Surface: Phosphatised finish with polished head.
- Material: Chrome-molybdenum steel.

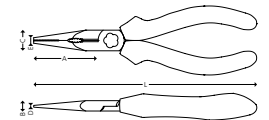

ITEM NO.	5704196+	L MM	Ø MAX. MM	D X E MM	A MM	B MM	C MM	G G	
3005-0160	007731	160	1,6	2,0 x 3,0	48,0	8,0	18,3	144	6
3005-0200	007748	200	2,0	3,0 x 4,0	70,0	10,7	21,4	238	6

**3002 DIAGONAL CUTTERS**

ISO 5749, DIN 5749

- Model with cutter for hard wire (160 kg/mm<sup>2</sup>).
  - Ergonomic handles with wide palm support.
  - Surface: Phosphatised finish with polished head.
- Material: Chrome-molybdenum steel.

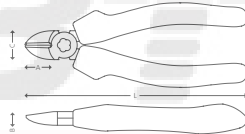

ITEM NO.	5704196+	L MM	Ø MAX. MM	A MM	B MM	C MM	G G	
3002-0125	007625	125	1,4	20,0	9,5	18,6	126	6
3002-0160	007656	160	1,6	20,0	10,0	19,6	188	6

**3006 HALF-ROUND NOSE PLIERS WITH BENT JAWS**

- Model with cutter for hard wire (160 kg/mm<sup>2</sup>) and knurled gripping surface.
  - Ergonomic handles with wide palm support.
  - Surface: Phosphatised finish with polished head.
- Material: Chrome-molybdenum steel.

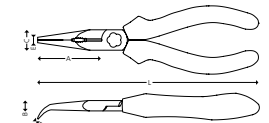

ITEM NO.	5704196+	L MM	Ø MAX. MM	D X E MM	A MM	B MM	C MM	G G	
3006-0160	007755	160	1,6	2,0 x 3,5	45,0	9,0	18,0	142	6
3006-0200	007762	200	2,0	2,5 x 4,0	65,0	10,5	21,5	234	6

**3004 HEAVY-DUTY DIAGONAL CUTTERS**

ISO 5749, DIN 5749

- Model with cutter for piano wire (200 kg/mm<sup>2</sup>).
  - Ergonomic handles with wide palm support.
  - Surface: Phosphatised finish with polished head.
- Material: Chrome-molybdenum steel.

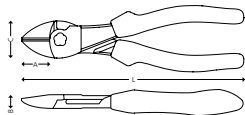

ITEM NO.	5704196+	L MM	Ø MAX. MM	A MM	B MM	C MM	G G	
3004-0180	015460	180	1,8	21,0	11,1	28,6	244	6
3004-0200	015590	200	2,0	21,0	12,2	29,7	293	6

**3009 WIRE STRIPPER**

- Model with opening spring and adjusting screw.
  - Ergonomic handles with wide palm support.
  - Surface: Phosphatised finish with polished head.
- Material: Chrome-molybdenum steel.

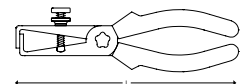

ITEM NO.	5704196+	MAX. MM <sup>2</sup>	L MM	G G	
3009-0160	007793	6	160	142	6



## POLAR® PLIERS



### 3020 BOX-JOINT WATER PUMP PLIER

ISO 8976, DIN 8976

- Model with 7 positions and knurled gripping surface.
  - Ergonomic handles with wide palm support.
  - Surface: Phosphatised finish with polished head.
- Material: Chrome-molybdenum steel.

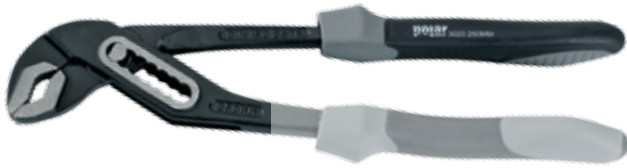
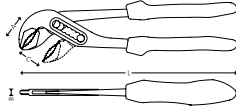

ITEM NO.	5704196+	L MM	A MM	B MM	C MM	G G	Icon
3020-0250	007922	250	35,0	8,0	34,0	354	6

### 3090 S/3 SET WITH 3 PLIERS

- Supplied in nylon bag.
- Content: 1 Combination plier (3001), 180 mm  
1 Diagonal cutter (3002), 160 mm  
1 Half-round long nose plier with straight jaws (3005), 160 mm



3  
TOOLS

ITEM NO.	5704196+	G G	Icon
3090-0003	013046	680	1
P3090-0003	017013	99	1

### 3050 4-IN-1 ELECTRICAL PLIER

- Model with cutter for hard wire (160 kg/mm<sup>2</sup>) and knurled gripping surface.
  - For stripping wire: 0,5 - 0,75 mm<sup>2</sup>.
  - For crimping terminals: 0,5 - 1,0 mm<sup>2</sup>.
  - Wire cutter: max. 0,96 mm diameter.
  - PVC coated handles.
  - Surface: Phosphatised finish with polished head.
- Material: Chrome-molybdenum steel.

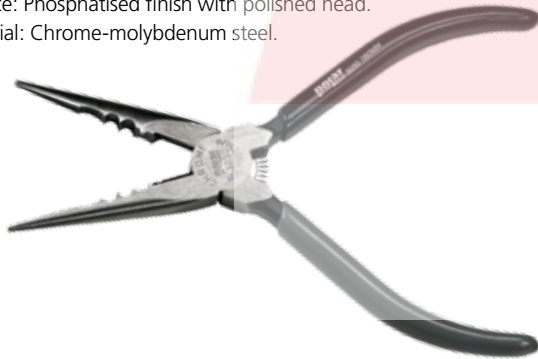
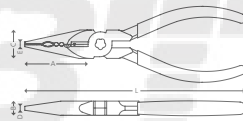

ITEM NO.	5704196+	L MM	Ø MAX MM	D X E MM	A MM	B MM	C MM	G G	Icon
3050-0160	013077	160	1,6	2,5 x 3,5	52,0	10,0	17,8	126	6

### 3090 S/5 SET WITH 5 PLIERS

- Supplied in nylon bag.
- Content: 1 Combination plier (3001), 180 mm  
1 Diagonal cutter (3002), 125 mm  
1 Heavy-duty diagonal cutter (3004), 180 mm  
1 Half-round long nose plier with straight jaws (3005), 160 mm  
1 Box-joint water pump plier (3020), 250 mm



5  
TOOLS

ITEM NO.	5704196+	G G	Icon
3090-0005	013053	1300	1
P3090-0005	017037	169	1





## POLAR® INSULATED PLIERS

### INSULATED PLIERS

#### 3001 INSUL. COMBINATION PLIER

IEC 60900:2004, ISO 5746, DIN 5746

- Every tool is individually tested to protect up to 1000V AC.
  - VDE and GS approved.
  - Model with cutter for piano wire (200 kg/mm<sup>2</sup>) and knurled gripping surface.
  - Ergonomic handles with wide palm support.
  - Surface: Phosphatised finish with polished head.
- Material: Chrome-molybdenum steel.

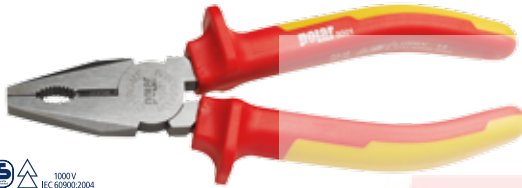
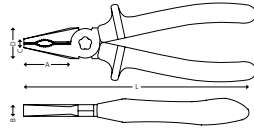

ITEM NO.	5704196+	L MM	Ø MAX. MM	A MM	B MM	C MM	D MM	G	6
3001-1180	000120	180	1,8	38,0	10,0	6,0	26,5	264	6

#### 3005 INSUL. HALF-ROUND LONG NOSE PLIERS WITH STRAIGHT JAWS

IEC 60900:2004, ISO 5745, DIN 5745

- Every tool is individually tested to protect up to 1000V AC.
  - VDE and GS approved.
  - Model with cutter for hard wire (160 kg/mm<sup>2</sup>) and knurled gripping surface.
  - Ergonomic handles with wide palm support.
  - Surface: Phosphatised finish with polished head.
- Material: Chrome-molybdenum steel.

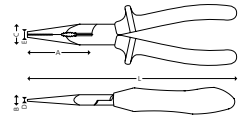

ITEM NO.	5704196+	L MM	Ø MAX MM	DXE MM	A MM	B MM	C MM	G	6
3005-1160	000151	160	1,6	2,0 x 3,0	48,0	8,0	18,3	146	6
3005-1200	000168	200	2,0	3,0 x 4,0	70,0	10,7	21,4	242	6

#### 3002 INSUL. DIAGONAL CUTTER

IEC 60900:2004, ISO 5749, DIN 5749

- Every tool is individually tested to protect up to 1000V AC.
  - VDE and GS approved.
  - Model with cutter for hard wire (160 kg/mm<sup>2</sup>).
  - Ergonomic handles with wide palm support.
  - Surface: Phosphatised finish with polished head.
- Material: Chrome-molybdenum steel.

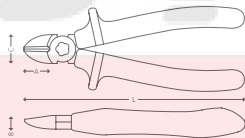

ITEM NO.	5704196+	L MM	Ø MAX. MM	A MM	B MM	C MM	G	6
3002-1160	000137	160	1,6	20,0	10,0	19,6	184	6

#### 3006 INSUL. HALF-ROUND NOSE PLIERS W/ BENT JAWS

IEC 60900:2004

- Every tool is individually tested to protect up to 1000V AC.
  - VDE and GS approved.
  - Model with cutter for hard wire (160 kg/mm<sup>2</sup>) and knurled gripping surface.
  - Ergonomic handles with wide palm support.
  - Surface: Phosphatised finish with polished head.
- Material: Chrome-molybdenum steel.

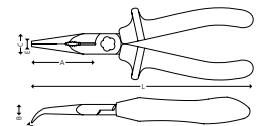

ITEM NO.	5704196+	L MM	Ø MAX MM	DXE MM	A MM	B MM	C MM	G	6
3006-0160	000175	160	1,6	2,0 x 3,5	45,0	9,0	18,0	144	6
3006-1200	000182	200	2,0	2,5 x 4,0	65,0	10,5	21,5	244	6

#### 3004 INSUL. HEAVY-DUTY DIAGONAL CUTTER

IEC 60900:2004, ISO 5749, DIN 5749

- Every tool is individually tested to protect up to 1000V AC.
  - VDE and GS approved.
  - Model with cutter for piano wire (200 kg/mm<sup>2</sup>).
  - Ergonomic handles with wide palm support.
  - Surface: Phosphatised finish with polished head.
- Material: Chrome-molybdenum steel.

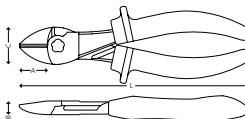

ITEM NO.	5704196+	L MM	Ø MAX. MM	A MM	B MM	C MM	G	6
3004-1180	000144	180	1,8	21,0	11,1	28,6	260	6

#### 3009 INSUL. WIRE STRIPPER

IEC 60900:2004

- Every tool is individually tested to protect up to 1000V AC.
  - VDE and GS approved.
  - Model with opening spring and adjusting screw.
  - Ergonomic handles with wide palm support.
  - Surface: Phosphatised finish with polished head.
- Material: Chrome-molybdenum steel.

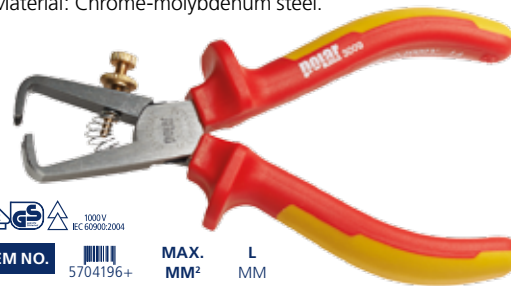
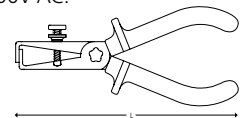

ITEM NO.	5704196+	MAX. MM <sup>2</sup>	L MM	G	6
3009-1160	000199	6	160	146	6





## POLAR® INSULATED PLIERS



### 3010 INSUL. CABLE CUTTER

IEC 60900:2004

- Every tool is individually tested to protect up to 1000V AC.
- VDE and GS approved.
- Precisely treated and sharpened jaws.
- Cuts single or multi-strand aluminum and copper cables.
- Ergonomic handles with wide palm support.
- Surface: Phosphatised finish with polished head.

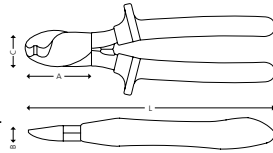

ITEM NO.	5704196+	L MM	Ø MAX.	A MM	B MM	C MM	G	6
3010-1160	000205	160	9 mm / 22 mm <sup>2</sup>	45	1,3	23,4	192	6

### 3011 INSUL. CABLE CUTTER

IEC 60900:2004

- Every tool is individually tested to protect up to 1000V AC.
- VDE and GS approved.
- Precisely treated and sharpened jaws.
- Cuts single or multi-strand aluminum and copper cables.
- Ergonomic handles with wide palm support.
- Surface: Phosphatised finish with polished head.

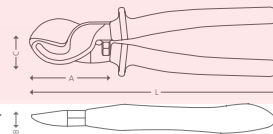

ITEM NO.	5704196+	L MM	Ø MAX.	A MM	B MM	C MM	G	6
3011-1250	000212	250	13 mm / 60 mm <sup>2</sup>	67	13	43	478	6

### 3020 INSUL. BOX-JOINT WATER PUMP PLIER

IEC 60900:2004, ISO 8976, DIN 8976

- Every tool is individually tested to protect up to 1000V AC.
- VDE and GS approved.
- Model with 7 positions and knurled gripping surface.
- Ergonomic handles with wide palm support.
- Surface: Phosphatised finish with polished head.

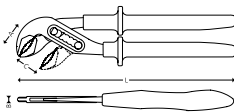

ITEM NO.	5704196+	L MM	A MM	B MM	C MM	G	6
3020-1250	000229	250	35,0	8,0	34,0	374	6

### 3091 S/4 INSULATED PLIER SET, 4 PCS.



- Supplied in nylon bag.
- Content: 1 Insulated combination plier (3001), 180 mm  
1 insulated diagonal plier (3002), 160 mm  
1 insulated long nose plier (3005), 160 mm  
1 insulated wire stripper (3009), 160 mm



4  
TOOLS

ITEM NO. 5704196+

3091-0004	023236							
P3091-0004	027036	Empty pouch for 3091-0004						

G	6
866	1
122	1

### 3091 S/7 INSULATED PLIER SET, 7 PCS.



- Supplied in nylon bag.
- Content: 1 Insulated combination plier (3001), 180 mm  
1 Insulated diagonal plier (3002), 160 mm  
1 Insulated long nose plier (3005), 160 mm  
1 Insulated wire stripper (3009), 160 mm  
1 Insulated cable cutter (3010), 160 mm  
1 Insulated water pump plier (3020), 250 mm  
1 Electricians Scissor (3500), 140 mm



7  
TOOLS

ITEM NO. 5704196+

3091-0007	023243							
P3091-0007	027043	Empty pouch for 3091-0007						

G	6
1596	1
224	1



## POLAR® PLIERS



### 3100 PLIERS WITH STRAIGHT JAWS - INTERNAL CIRCLIPS

- PVC coated handles.
- Surface: Phosphatised finish with polished head.
- Material: Chrome-molybdenum steel.

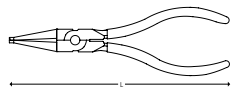

ITEM NO.	5704196+	Ø MIN. - MAX. MM	L MM
3100-0825	007809	8 - 25	135
3100-1960	007816	19 - 60	175

G	Box
77	10
12	10

### 3115 PLIERS WITH NOSE BENT 90° - EXTERNAL CIRCLIPS

- PVC coated handles.
- Surface: Phosphatised finish with polished head.
- Material: Chrome-molybdenum steel.

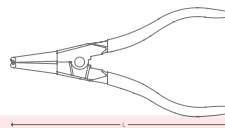
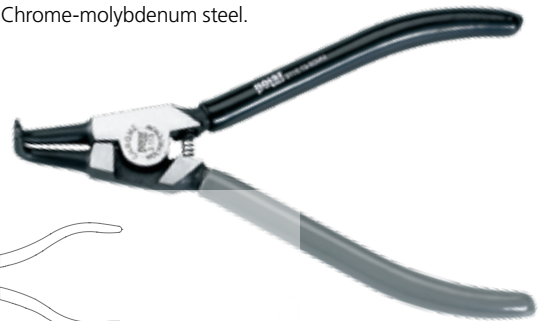

ITEM NO.	5704196+	Ø MIN. - MAX. MM	L MM
3115-0825	007892	8 - 25	128
3115-1960	007908	19 - 60	165

G	Box
86	10
152	10

### 3105 PLIERS WITH NOSE BENT 90° - INTERNAL CIRCLIPS

- PVC coated handles.
- Surface: Phosphatised finish with polished head.
- Material: Chrome-molybdenum steel.

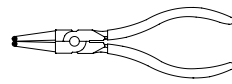
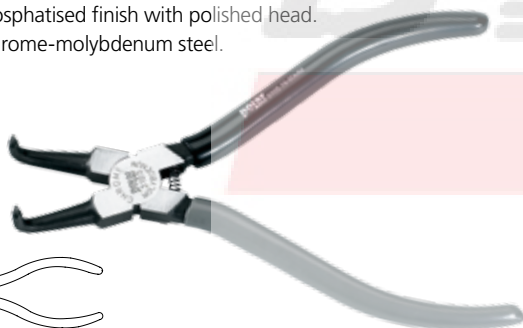

ITEM NO.	5704196+	Ø MIN. - MAX. MM	L MM
3105-0825	007830	8 - 25	128
3105-1960	007847	19 - 60	165

G	Box
83	10
127	10

### 3190 S/4 SET WITH 4 PLIERS FOR CIRCLIPS

- Supplied in nylon bag.
- Content: 1 Plier with straight jaws for internal circlips, 19 - 60 mm  
1 Plier with nose bent 90° for internal circlips, 19 - 60 mm  
1 Plier with straight jaws for external circlips, 19 - 60 mm  
1 Plier with nose bent 90° for external circlips, 19 - 60 mm



4  
TOOLS

### 3110 PLIERS WITH STRAIGHT JAWS - EXTERNAL CIRCLIPS

- PVC coated handles.
- Surface: Phosphatised finish with polished head.
- Material: Chrome-molybdenum steel.

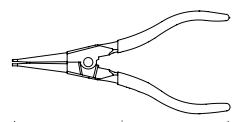

ITEM NO.	5704196+	Ø MIN. - MAX. MM	L MM
3110-0825	007861	8 - 25	135
3110-1960	007878	19 - 60	175

G	Box
92	10
157	10

ITEM NO.	5704196+	G	Box
3190-0004	013060	740	1
P3190-0004	017044	163	1

G	Box
740	1
163	1



LOCKING PLIERS

**3200 LOCKING PLIERS**

- Model with curved jaws with cutter.
- Surface: Nickel plated. Material: Chrome-vanadium steel jaws.

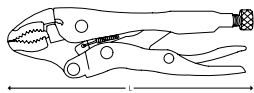

ITEM NO.	5704196+	L MM	L "	A MM	G	
3200-0125	008004	125	5"	29	180	6
3200-0180	008011	180	7"	41	345	6
3200-0250	008028	250	10"	48	515	6

**3205 LOCKING PLIERS**

- Model with long jaws.
- Surface: Nickel plated. Material: Chrome-vanadium steel jaws.

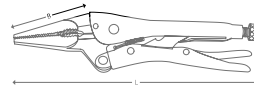

ITEM NO.	5704196+	L MM	L "	A MM	B MM	G	
3205-0150	008073	150	6"	57	50	175	6
3205-0225	008080	225	9"	70	60	370	6

**3202 LOCKING PLIERS**

- Model with curved jaws.
- Surface: Nickel plated. Material: Chrome-vanadium steel jaws.

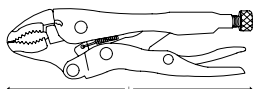

ITEM NO.	5704196+	L MM	L "	A MM	G	
3202-0180	008035	180	7"	41	345	6
3202-0250	008042	250	10"	48	515	6

**3210 SHEET METAL PLIER**

- Model for clamping sheet metal without gripping effort.
- Surface: Nickel plated. Material: Chrome-vanadium steel jaws.

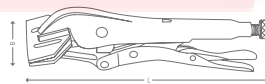

ITEM NO.	5704196+	L MM	L "	A MM	B MM	G	
3210-0200	008097	250	5"	40	75	695	6

**3203 LOCKING PLIERS**

- Model with straight jaws.
- Surface: Nickel plated. Material: Chrome-vanadium steel jaws.

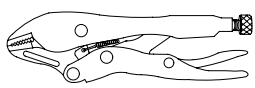

ITEM NO.	5704196+	L MM	L "	A MM	G	
3203-0180	008059	180	7"	43	380	6
3203-0250	008066	250	10"	50	600	6

**3215 WELDING CLAMP**

- Model with U-shaped jaws. Allows access and good visibility when welding.
- Surface: Nickel plated. Material: Chrome-vanadium steel jaws.



ITEM NO.	5704196+	L MM	L "	A MM	B MM	C MM	D MM	G	
3215-0225	008103	280	11"	55	60	90	70	845	6



## POLAR® PLIERS



### 3220 C-CLAMP LOCKING PLIERS

- Model for clamping metal profiles.
- Surface: Nickel plated. Material: Chrome-vanadium steel jaws.

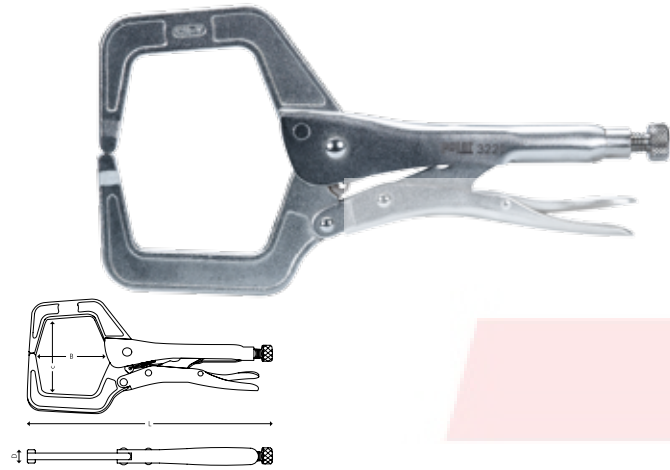

ITEM NO.	5704196+	L MM	L "	A MM	B MM	C MM	D MM	G G	
3220-0150	008110	175	7"	45	40	50	10	235	6
3220-0275	008127	275	11"	80	80	95	11	720	6

### 3500 A ELECTRICIANS SCISSOR

- Model with plast moulded sheathing. Short blades with wire cutter.
- Surface: Nickel plated finish. Material: Carbon steel.

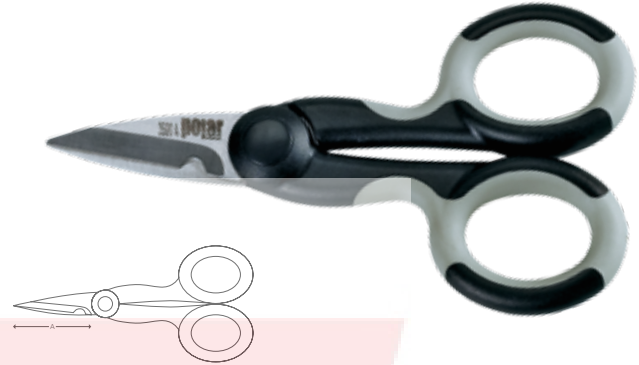

ITEM NO.	5704196+	L MM	A MM	G G	
3500-0140	013084	140	45	74	4

## CUTTING SHEARS

### 3400 METAL CUTTING SHEARS

- Internal torsion spring. Serrated edges prevent slipping.
- Plastic handle with rubber grip. Safety latch.
- Cutting capacity: Stainless steel: 0,7 mm. Cold rolled steel: 1,2 mm
- Material: Chrome-molybdenum alloy steel blades.

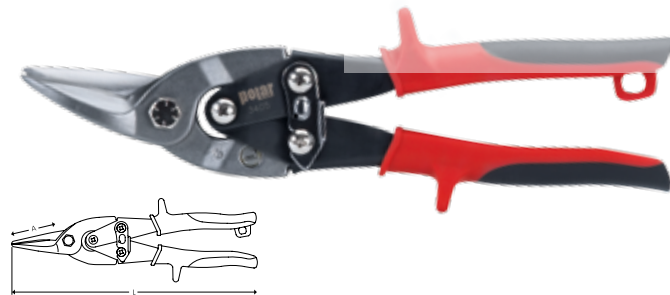

ITEM NO.	5704196+	CUT	COLOR	A MM	L MM	G G	
3400-0250	008172	Right	Green	35	248	375	6
3405-0250	008189	Left	Red	35	248	375	6
3410-0250	008196	Straight	Yellow	35	250	380	6





## POLAR® PLIERS



### FILES

#### 3900 FLAT FILE

ISO 234, DIN 7285

- Ergonomic soft grip handle.



ITEM NO.	5704196+	FILE TYPE	SHAPE	A X B MM	L MM	G	
3900-0200	013879	Medium		20 x 5,0	200	211	10

#### 3904 TRIANGULAR FILE

ISO 234, DIN 7285

- Ergonomic soft grip handle.



ITEM NO.	5704196+	FILE TYPE	SHAPE	A MM	L MM	G	
3904-0200	013916	Medium		13	200	203	10

#### 3901 ROUND FILE

ISO 234, DIN 7285

- Ergonomic soft grip handle.



ITEM NO.	5704196+	FILE TYPE	SHAPE	Ø MM	L MM	G	
3901-0200	013886	Medium		8	200	158	10

#### 3990 S5 FILE SET

- Second cut.
- Supplied in nylon bag.



#### 3902 HALFRound FILE

ISO 234, DIN 7285

- Ergonomic soft grip handle.



ITEM NO.	5704196+	FILE TYPE	SHAPE	A X B MM	L MM	G	
3902-0200	013893	Medium		20 x 6,5	200	229	10

#### 3903 SQUARE FILE

ISO 234, DIN 7285

- Ergonomic soft grip handle.



ITEM NO.	5704196+	FILE TYPE	SHAPE	A X A MM	L MM	G	
3903-0200	013909	Medium		7 x 7	200	150	10

ITEM NO.	5704196+	QTY.	TYPE	G	
3990-0005	013862	5	Flat - Round - Halfround - Square - Triangular	1084	1
P3990-0005	017051	1	Empty pouch for 3990-0005	137	1





## POLAR® SCREWDRIVERS AND BITS



Ergonomic soft  
grip handle

Chrome-molybdenum  
steel blade

Chrome plated blade  
with burnished tip



## POLAR® SCREWDRIVERS AND BITS



# SCREWDRIVERS

POLAR® screwdrivers offer a great combination of power and comfort.

- Unique handle shape providing excellent grip and superior force.
- Bi-material gives you soft grip – even in the greasiest shop environments.
- The tip types are marked on each handle to quickly find the right type for the job.
- The blade is made of chrome-molybdenum steel for the highest torque performance.
- The wide range includes also screwdrivers with go-through blades and insulated screwdrivers.



Slotted



Phillips®  
Tel: (+974) 443 54 298  
www.boltsandtools.com



Pozidriv®



Torx®



Tamper resist Torx®  
Tel: (+974) 443 54 298  
www.boltsandtools.com



With Ball-point

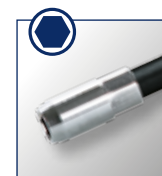

Hexagon  
Tel: (+974) 443 54 298  
www.boltsandtools.com



## POLAR® SCREWDRIVERS AND BITS



### SCREWDRIVERS

#### 4000 SCREWDRIVERS FOR SLOTTED HEAD SCREWS

ISO 2380, DIN 5264

- Ergonomic soft grip handle.
- Surface: Chrome plated blade with burnished tip.  
Material: Chrome-molybdenum steel blade.
- Note: art. 4000-0030 is supplied with cylindrical blade.

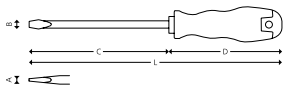

ITEM NO.	5704196+	A X B X C MM	D MM	L MM	G	
4000-0030	006697	0,5 x 3 x 75	85	160	30	10
4000-0040	006703	0,8 x 4 x 100	105	205	56	10
4000-0055	006710	1,0 x 5,5 x 125	105	230	69	10
4000-0065	006727	1,2 x 6,5 x 150	115	265	102	10
4000-0080	006734	1,2 x 8 x 175	125	300	172	10

#### 4010 PH SCREWDRIVERS FOR PHILLIPS® HEAD SCREWS

ISO 8764, DIN 5260

- Ergonomic soft grip handle.
- Surface: Chrome plated blade with burnished tip.  
Material: Chrome-molybdenum steel blade.

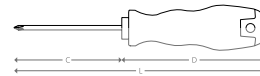

ITEM NO.	5704196+	PH	C MM	D MM	L MM	G	
4010-0100	006772	0	60	85	145	29	10
4010-0101	006789	1	80	105	185	60	10
4010-0102	006796	2	100	115	215	86	10
4010-0103	006802	3	150	125	275	165	10

#### 4001 SCREWDRIVERS FOR SLOTTED HEAD SCREWS

- Supplied with go-through blade and hexagonal bolster.
- Ergonomic soft grip handle with impact cap.
- Surface: Chrome plated blade with burnished tip.  
Material: Chrome-molybdenum steel blade.

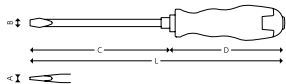

ITEM NO.	5704196+	A X B X C MM	D MM		L MM	G	
4001-0055	016597	1,0 x 5,5 x 125	110	8	235	98	6
4001-0065	016603	1,2 x 6,5 x 125	120	10	245	137	6
4001-0080	016610	1,2 x 8 x 175	130	13	305	227	6
4001-0100	016627	1,6 x 10 x 200	130	16	330	278	10
4001-0120	016634	2 x 12 x 200	130	16	330	318	6

#### 4011 PH SCREWDRIVERS FOR PHILLIPS® HEAD SCREWS

- Supplied with go-through blade and hexagonal bolster.
- Ergonomic soft grip handle with impact cap.
- Surface: Chrome plated blade with burnished tip.  
Material: Chrome-molybdenum steel blade.

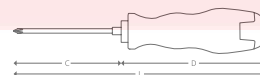
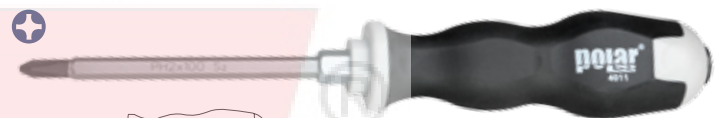

ITEM NO.	5704196+	PH	C MM	D MM		L MM	G	
4011-0101	016641	1	80	110	8	190	88	6
4011-0102	016658	2	100	120	10	220	131	6
4011-0103	016665	3	150	130	13	280	219	6
4011-0104	016672	4	200	130	16	330	315	6

#### 4003 STUBBY SCREWDRIVERS FOR SLOTTED HEAD SCREWS

ISO 2380, DIN 5264

- Ergonomic soft grip handle.
- Surface: Chrome plated blade with burnished tip.  
Material: Chrome-molybdenum steel blade.

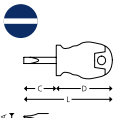

ITEM NO.	5704196+	A X B X C MM	D MM	L MM	G	
4003-0055	006758	1,0 x 5,5 x 25	50	75	36	10
4003-0065	006765	1,0 x 6,5 x 25	50	75	40	10

#### 4013 PH STUBBY SCREWDRIVERS FOR PHILLIPS® HEAD SCREWS

ISO 8764, DIN 5260

- Ergonomic soft grip handle.
- Surface: Chrome plated blade with burnished tip.  
Material: Chrome-molybdenum steel blade.



ITEM NO.	5704196+	PH	C MM	D MM	L MM	G	
4013-0101	006819	1	25	50	75	34	10
4013-0102	006826	2	25	50	75	38	10





## POLAR® SCREWDRIVERS AND BITS



### 4020 PZ SCREWDRIVERS FOR POZIDRIV® HEAD SCREWS

ISO 8764, DIN 5260

- Ergonomic soft grip handle.
  - Surface: Chrome plated blade with burnished tip.
- Material: Chrome-molybdenum steel blade.



ITEM NO.	5704196+	PZ	C MM	D MM	L MM	G	Icon
4020-0101	006833	1	80	105	185	60	10
4020-0102	006840	2	100	115	215	86	10
4020-0103	006857	3	150	125	275	165	10

### 4090 SCREWDRIVER SET - 7 PCS.

- Supplied in carton box.



ITEM NO.	5704196+	QTY.	SIZE	G	Icon
4090-0007	000800	7	3 x 75 - 4 x 100 - 5,5 x 125 PH1 x 80 - PH2 x 100 PZ1 x 80 - PZ2 x 100	640	1

### 4021 PZ SCREWDRIVERS FOR POZIDRIV® HEAD SCREWS

- Supplied with go-through blade and hexagonal bolster.
  - Ergonomic soft grip handle with impact cap.
  - Surface: Chrome plated blade with burnished tip.
- Material: Chrome-molybdenum steel blade.

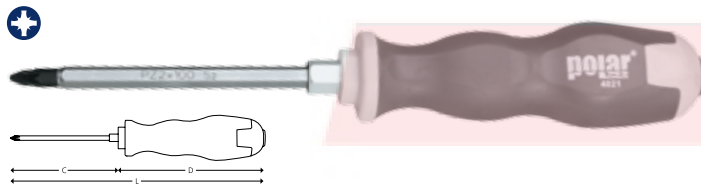

ITEM NO.	5704196+	PZ	C MM	D MM	L MM	G	Icon	
4021-0101	016689	1	80	110	8	190	88	6
4021-0102	016696	2	100	120	10	220	131	6
4021-0103	016702	3	150	130	13	280	219	6
4021-0404	016719	4	200	130	16	330	315	6

### 4090 SCREWDRIVER SET - 10 PCS.

- Supplied in carton box.



ITEM NO.	5704196+	QTY.	SIZE	G	Icon
4090-0010	000824	10	3 x 75 - 4 x 100 - 5,5 x 125 - 6,5 x 150 PH1 x 80 - PH2 x 100 - PH3 x 150 PZ1 x 80 - PZ2 x 100 - PZ3 x 150	1115	1

### 4023 PZ STUBBY SCREWDRIVERS FOR POZIDRIV® HEAD SCREWS

ISO 8764, DIN 5260

- Ergonomic soft grip handle.
  - Surface: Chrome plated blade with burnished tip.
- Material: Chrome-molybdenum steel blade.



ITEM NO.	5704196+	PH	C MM	D MM	L MM	G	Icon
4023-0101	006864	1	25	50	75	34	10
4023-0201	006871	2	25	50	75	38	10



## POLAR® SCREWDRIVERS AND BITS

### 4090 SCREWDRIVER SET - 7 PCS.

▪ Supplied in carton box.



7  
TOOLS

ITEM NO.	5704196+	QTY.	SIZE	G	1
4090-1007	000817	7	3 x 75 - 4 x 100 - 5,5 x 125 - 6,5 x 150 - PH1 x 80 - PH2 x 100 - PH3 x 150	755	1

### 4091 SCREWDRIVER SET WITH IMPACT CAP - 6 PCS.

▪ Supplied in carton box.



6  
TOOLS

ITEM NO.	5704196+	QTY.	SIZE	G	1
4091-0006	016740	6	5,5 x 125 - 6,5 x 150 - 10 x 200 - PH1 x 80 - PH2 x 100 - PH3 x 150	1090	1

### 4090 SCREWDRIVER SET - 12 PCS.

▪ Supplied in plastic case.



12  
TOOLS

ITEM NO.	5704196+	QTY.	SIZE	G	1
4090-0012	024905	12	3 x 75 - 4 x 100 - 5,5 x 125 - 6,5 x 150 - PH1 x 80 - PH2 x 100 - PH3 x 150 - PZ1 x 80 - PZ2 x 100 - PZ3 x 150 - Stubby screwdriver 5,5 x 25 - Stubby screwdriver PH2 x 25	194	1





## POLAR® SCREWDRIVERS AND BITS



### 4091 SCREWDRIVER SET WITH IMPACT CAP - 7 PCS.

▪ Supplied in carton box.



6 TOOLS

ITEM NO.	5704196+	QTY.	SIZE	G	1
4091-0007	016726	7	5,5 x 125 - 6,5 x 150 - 8 x 175 - 10 x 200 12 x 200 - PH2 x 100 - PH3 x 150	1580	1

### 4031 TX SCREWDRIVERS FOR TORX® HEAD SCREWS

▪ Ergonomic soft grip handle.

▪ Surface: Chrome plated blade with burnished tip.

Material: Chrome-molybdenum steel blade.



ITEM NO.	5704196+	TORX® NO.	MM	C MM	D MM	L MM	G	10
4031-0008	015187	T8	2,31	60	85	145	31	10
4031-0010	015194	T10	2,74	80	105	185	56	10
4031-0015	015200	T15	3,27	80	105	185	56	10
4031-0020	015217	T20	3,86	100	105	205	58	10
4031-0025	015224	T25	4,43	100	105	205	68	10
4031-0027	015231	T27	4,99	115	115	230	98	10
4031-0030	015248	T30	5,52	115	115	230	98	10
4031-0040	015255	T40	6,65	130	115	245	118	10

### 4090 SCREWDRIVER SET FOR TORX® HEAD SCREWS - 8 PCS.

▪ Supplied in carton box.



8 TOOLS

ITEM NO.	5704196+	QTY.	SIZE	G	1
4090-1008	015330	8	TX T8 x 60 - T10 x 80 - T15 x 80 - T20 x 100 - T25 x 100 - T27 x 115 - T30 x 115 - T40 x 130	740	1

### 4091 SCREWDRIVER SET WITH IMPACT CAP - 10 PCS.

▪ Supplied in carton box.



10 TOOLS

ITEM NO.	5704196+	QTY.	SIZE	G	1
4091-0010	016733	10	5,5 x 125 - 6,5 x 150 - 8 x 175 - 10 x 200 PH1 x 80 - PH2 x 100 - PH3 x 150 PZ1 x 80 - PZ2 x 100 - PZ3 x 150	1840	1



## POLAR® SCREWDRIVERS AND BITS

### 4030 STX SCREWDRIVERS FOR TAMPER RESISTANT® TORX® HEAD SCREWS

- Ergonomic soft grip handle.
- Surface: Chrome plated blade with burnished tip.
- Material: Chrome-molybdenum steel blade.



ITEM NO.	5704196+	TORX® NO.	MM	C MM	D MM	L MM	G	
4030-0008	006888	T8	2,31	60	85	145	31	10
4030-0010	006895	T10	2,74	80	85	165	56	10
4030-0015	006901	T15	3,27	80	105	185	56	10
4030-0020	006918	T20	3,86	100	105	205	58	10
4030-0025	006925	T25	4,43	100	105	205	68	10
4030-0027	006932	T27	4,99	115	115	230	98	10
4030-0030	006949	T30	5,52	115	115	230	98	10
4030-0040	006956	T40	6,65	130	115	245	118	10

### 4035 HBP SCREWDRIVERS WITH BALL-POINT FOR HEX HEAD SCREWS

- Ergonomic soft grip handle.
- Surface: Chrome plated blade with burnished tip.
- Material: Chrome-molybdenum steel blade.



ITEM NO.	5704196+	SIZE MM	C MM	D MM	L MM	G	
4035-0025	015262	2,5	100	85	185	33	10
4035-0030	015279	3	100	85	185	34	10
4035-0040	015286	4	100	105	205	68	10
4035-0050	015293	5	100	105	205	70	10
4035-0060	015309	6	125	115	240	105	10
4035-0080	015316	8	150	128	278	177	10
4035-0100	015323	10	150	128	278	229	10

### 4090 SCREWDRIVER SET FOR TAMPER RESISTANT® TORX® HEAD SCREWS

- Supplied in carton box.



ITEM NO.	5704196+	QTY.	SIZE	G	
4090-0008	000831	8	STX T8 x 60 - T10 x 80 - T15 x 80 - T20 x 100 - T25 x 100 - T27 x 115 - T30 x 115 - T40 x 130	740	1

### 4042 F FLEXIBLE HEXAGONAL NUT DRIVERS

- Ergonomic soft grip handle.
- Maximum torque: 10 Nm.
- Surface: Chrome plated finish. Material: Chrome-vanadium steel.



ITEM NO.	5704196+	SIZE MM	C MM	D MM	L MM	G	
4042-0014	006987	1/4"	160	115	275	135	10
4042-0060	006963	6 mm	160	115	275	135	10
4042-0070	006970	7 mm	160	115	275	135	10

### 4043 M 1/4" MAGNETIC BIT HOLDING SCREWDRIVER

- Ergonomic soft grip handle.
- Model with 6 mm hexagonal blade.
- Surface: Chrome plated finish. Material: Chrome-vanadium steel.



ITEM NO.	5704196+	SIZE MM	C MM	D MM	L MM	G	
4043-0014	006994	1/4"	100	115	215	106	10



# POLAR® SCREWDRIVERS AND BITS



## INSULATED SCREWDRIVERS

### 4200 INSULATED SCREWDRIVERS FOR SLOTTED HEAD SCREWS

IEC 60900:2004, ISO 2380, DIN 5264

- Every tool is individually tested to protect up to 1000V AC.
- VDE and GS approved.
- Insulation moulded directly onto the blade.
- Ergonomic soft grip handle.
- Cylindrical blade.
- Surface: Insulated blade with burnished tip.
- Material: Chrome-molybdenum steel blade.

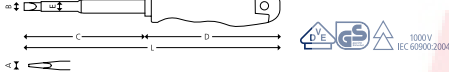
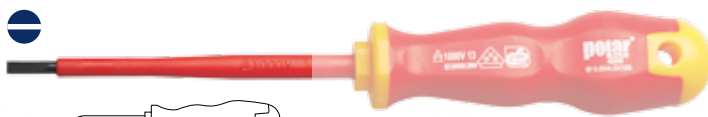

ITEM NO.	5704196+	A X B X C MM	D MM	E MM	L MM	G	
4200-0025	022949	0,2 x 2,5 x 75	85	4,2	160	28	10
4200-0030	022956	0,5 x 3,0 x 100	85	4,7	185	32	10
4200-0035	022963	0,8 x 3,5 x 100	85	5,3	185	34	10
4200-0040	022970	0,8 x 4,0 x 100	105	6,0	215	58	10
4200-0055	022987	1,0 x 5,5 x 125	105	7,4	230	78	10
4200-0065	022994	1,2 x 6,5 x 150	115	8,5	270	114	10
4200-0080	023007	1,2 x 8,0 x 175	125	9,9	300	185	10

### 4220 INSULATED SCREWDRIVERS FOR POZIDRIV® HEAD SCREWS

IEC 60900:2004, ISO 8764, DIN 5260

- Every tool is individually tested to protect up to 1000V AC.
- VDE and GS approved.
- Insulation moulded directly on to the blade.
- Ergonomic soft grip handle.
- Surface: Insulated blade with burnished tip.
- Material: Chrome-molybdenum steel blade.

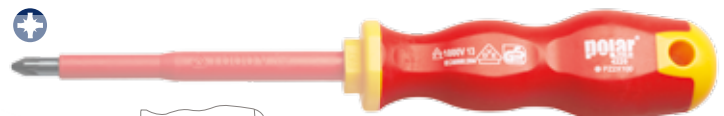

ITEM NO.	5704196+	PZ	C MM	D MM	E MM	L MM	G	
4220-0100	023052	0	60	85	4,7	145	29	10
4220-0101	023069	1	80	105	6,8	190	64	10
4220-0102	023076	2	100	115	7,8	215	94	10
4220-0103	023083	3	150	125	9,9	280	173	10

### 4210 INSULATED SCREWDRIVERS FOR PHILLIPS® HEAD SCREWS

IEC 60900:2004, ISO 8764, DIN 5260

- Every tool is individually tested to protect up to 1000V AC.
- VDE and GS approved.
- Insulation moulded directly on to the blade.
- Ergonomic soft grip handle.
- Surface: Insulated blade with burnished tip.
- Material: Chrome-molybdenum steel blade.

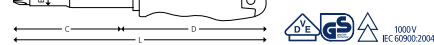

ITEM NO.	5704196+	PH	C MM	D MM	E MM	L MM	G	
4210-0100	023014	0	60	85	4,7	145	29	10
4210-0101	023021	1	80	105	6,8	190	64	10
4210-0102	023038	2	100	115	7,8	215	94	10
4210-0103	023045	3	150	125	9,9	280	173	10

### 4202 VOLTAGE TESTER

- VDE and GS approved.
- Transparent handle with clip.
- Insulation moulded directly onto the blade.
- Cylindrical blade.
- Surface: Insulated chrome plated blade.
- Material: Chrome-vanadium steel blade.

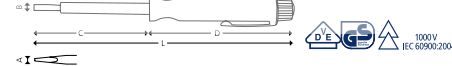

ITEM NO.	5704196+	A X B X C MM	D MM	L MM	G	
4202-0030	023090	0,5 x 3,0 x 60	80	140	16	10





**POLAR®**

**INSULATED SCREWDRIVERS**

**4290 INSULATED SCREWDRIVER SET - 6 PCS.**

■ Supplied in carton box.



6 TOOLS



ITEM NO.	5704196+	QTY.	SIZE	G	1
4290-0006	023106	6	2.5 x 75 - 3.5 x 100 - 4.0 x 100 - 5.5 x 125 PH1 x 80 - PH2 x 100	492	1

**4290 INSULATED SCREWDRIVER SET - 9 PCS.**

■ Supplied in carton box.



9 TOOLS



ITEM NO.	5704196+	QTY.	SIZE	G	1
4290-0009	023113	9	2.5 x 75 - 4.0 x 100 - 5.5 x 125 - 6.5 x 150 PH1 x 80 - PH2 x 100 PZ1 x 80 - PZ2 x 100 Voltage tester 110-250 V	790	1





# POLAR® SCREWDRIVERS AND BITS



## SCREWDRIVERS

### 4045 S/5 3-IN-1 RATCHET BIT SCREWDRIVER

- 3 different handle positions.
- Magnetic bit holding ratchet screwdriver with 10 teeth.
- 5 pcs. bit holder inside the handle.
- Surface: Chrome plated finish. Material: Chrome-vanadium steel.
- Content:
  - 1 Bits for slotted head screws 4514 1/4" 6 mm
  - 2 Bits for Phillips® screws 4514 1/4" PH 1 - 2
  - 2 Bits for Pozidriv® screws 4514 1/4" PZ 1 - 2

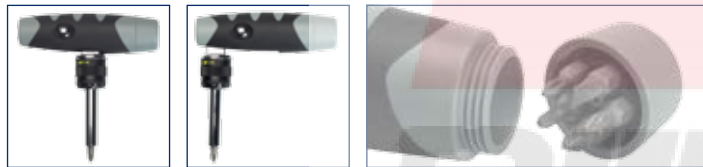

ITEM NO.	5704196+
4045-0005	019024

DIMENSIONS	G	MM
200 x 35 mm	250	1

### 4410 PH SCREWDRIVERS FOR PHILLIPS® HEAD SCREWS

- Ergonomic soft grip handle.
- Revolving head for precision action.
- Surface: Chrome plated blade with burnished tip.  
Material: Chrome-molybdenum steel blade.



ITEM NO.	5704196+	PH	C	D	L	G	MM	MM	MM	MM
4410-0000	014999	000	40	98	138	12	10			
4410-0010	015002	00	75	98	173	14	10			
4410-0100	015019	0	75	98	173	16	10			
4410-0101	015026	1	75	98	173	21	10			

### 4431 TX SCREWDRIVERS FOR TORX® HEAD SCREWS

- Ergonomic soft grip handle.
- Revolving head for precision action.
- Surface: Chrome plated blade with burnished tip.  
Material: Chrome-molybdenum steel blade.



ITEM NO.	5704196+	TORX® NO.	MM	C	D	L	G	MM	MM	MM
4431-0005	015095	T5	1,35	40	98	138	12	10		
4431-0006	015101	T6	1,67	40	98	138	12	10		
4431-0007	015118	T7	1,99	40	98	138	13	10		
4431-0008	015125	T8	2,30	40	98	138	13	10		
4431-0009	015132	T9	2,50	75	98	173	16	10		
4431-0010	015149	T10	2,72	75	98	173	16	10		
4431-0015	015156	T15	3,26	75	98	173	19	10		
4431-0020	015163	T20	3,84	75	98	173	21	10		

### 4400 SCREWDRIVERS FOR SLOTTED HEAD SCREWS

- Ergonomic soft grip handle.
- Revolving head for precision action.
- Surface: Chrome plated blade with burnished tip.  
Material: Chrome-molybdenum steel blade.

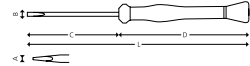

ITEM NO.	5704196+	A X B X C	D	L	G	MM	MM	MM
4400-0010	014937	0,2 x 1 x 40	98	138	12	10		
4400-0015	014944	0,4 x 1,5 x 40	98	138	12	10		
4400-0018	014951	0,4 x 1,8 x 75	98	173	13	10		
4400-0020	014968	0,5 x 2 x 75	98	173	13	10		
4400-0025	014975	0,5 x 2,5 x 75	98	173	14	10		
4400-0030	014982	0,5 x 3 x 75	98	173	16	10		

### 4430 STX SCREWDRIVERS FOR TAMPER RESISTANT® TORX® HEAD SCREWS

- Ergonomic soft grip handle.
- Revolving head for precision action.
- Surface: Chrome plated blade with burnished tip.  
Material: Chrome-molybdenum steel blade.



ITEM NO.	5704196+	TORX® NO.	MM	C	D	L	G	MM	MM	MM
4430-0007	015033	T7	1,99	40	98	138	13	10		
4430-0008	015040	T8	2,30	40	98	138	13	10		
4430-0009	015057	T9	2,50	75	98	173	16	10		
4430-0010	015064	T10	2,72	75	98	173	16	10		
4430-0015	015071	T15	3,26	75	98	173	19	10		
4430-0020	015088	T20	3,84	75	98	173	21	10		



## POLAR® SCREWDRIVERS AND BITS

### 4490 S/8 SCREWDRIVER SET

▪ Supplied in nylon bag.



ITEM NO.	5704196+	QTY.	SIZE	G	
4490-0008	014913	8	1,0 x 40 - 1,5 x 40 - 1,8 x 78 - 2,0 x 75 - 2,5 x 75 PH00 x 75 - PH0 x 75 - PH1 x 75	154	1
P4490-0008	027050	1	Empty pouch for 4490-0008	46	1

### 4490TXS/8 SCREWDRIVER SET FOR TORX® HEAD SCREWS

▪ Supplied in nylon bag.



ITEM NO.	5704196+	QTY.	SIZE	G	
4490-1008	014920	8	TX T5 x 40 - T6 x 40 - T7 x 40 - T8 x 40 - T9 x 75 T10 x 75 - T15 x 75 - T20 x 75	161	1
P4490-1008	027067	1	Empty pouch for 4490-1008	46	1

### 4490 A 1/4" PRECISION BITS AND SOCKET WRENCH SET

ITEM NO. 4490-0031

▪ Set in metal box with 19 pcs. 4 mm bits,  
10 pcs. 1/4" sockets, 1/4" adaptor and  
bit holding screwdriver.

▪ 31 tools.

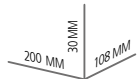

0,61 KG

5704196 015170

1

CONTENT:

QTY.	DESCRIPTION	SIZE
4	4 mm bits for slotted head screws	2 - 2.5 - 3 - 4 mm
2	4 mm bits for Phillips® screws	PH 00 - 0
2	4 mm bits for Pozidriv® screws	PZ 00 - 0
5	4 mm bits for Torx® screws	TX T6 - T7 - T8 - T9 - T10
3	4 mm bits for hex head screws	H 1.5 - 2 - 2.5
3	4 mm bits for hex head screws	HBP 1.5 - 2 - 2.5
5	1/4" 6-point sockets	3.2 - 4 - 5 - 5.5 - 7 mm
5	1/4" sockets for Torx® screws	NTX E4 - E5 - E6 - E7 - E8
1	Adaptor	4 mm x 1/4"
1	Bit holding screwdriver	4 mm





## POLAR® SCREWDRIVERS AND BITS



## L-SHAPED WRENCHES

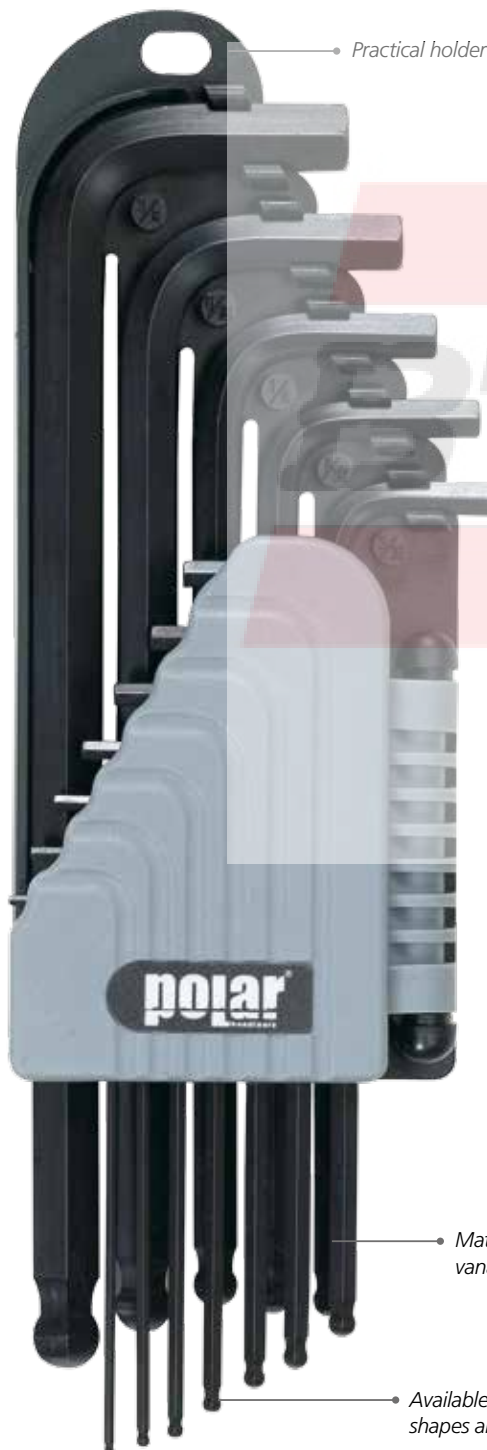

### 4100 METRIC HEXAGON KEYS

ISO 2936, DIN 911

- Surface: Phosphatised finish. Material: Chrome-vanadium steel.



ITEM NO.	5704196+	SIZE MM	A MM	L MM	G	
4100-0015	012797	1,5	14	45	1	1
4100-0002	012803	2	15	50	2	1
4100-0025	012810	2,5	18	55	3	1
4100-0003	012827	3	20	62	5	1
4100-0004	012834	4	23	70	10	1
4100-0005	012841	5	29	80	18	1
4100-0006	012858	6	32	90	30	1
4100-0007	012865	7	34	95	43	1
4100-0008	012872	8	36	100	60	1
4100-0009	012889	9	38	105	80	1
4100-0010	012896	10	40	112	105	1
4100-0012	012902	12	45	125	170	1
4100-0014	012919	14	54	140	265	1
4100-0017	012926	17	61	160	440	1
4100-0019	012933	19	70	180	625	1
4100-0022	012940	22	80	200	935	1
4100-0024	012957	24	90	225	1250	1

### 4105 BP METRIC LONG HEXAGON KEYS WITH BALL-POINT

- The ball-point provides a working angle up to 25°.
- Surface: Phosphatised finish. Material: Chrome-vanadium steel.



ITEM NO.	5704196+	SIZE MM	A MM	L MM	G	
4105-0015	012575	1,5	15	74	1	1
4105-0002	012582	2	16	80	3	1
4105-0025	012599	2,5	18	87	5	1
4105-0003	012605	3	20	96	7	1
4105-0004	012612	4	24	107	14	1
4105-0005	012629	5	28	120	26	1
4105-0006	012636	6	32	136	42	1
4105-0007	012643	7	34	144	60	1
4105-0008	012650	8	36	154	84	1
4105-0010	012667	10	40	172	147	1



## POLAR® SCREWDRIVERS AND BITS

### 4105 IBP INCH LONG HEXAGON KEYS WITH BALL-POINT

- The ball-point provides a working angle up to 25°.
- Surface: Phosphatised finish. Material: Chrome-vanadium steel.



ITEM NO.	5704196+	SIZE MM	A MM	L MM	G	
4105-1002	012674	1/16"	15	74	1	1
4105-1025	012681	5/64"	16	80	3	1
4105-1003	012698	3/32"	18	87	4	1
4105-1035	012704	7/64"	19	92	6	1
4105-1004	012711	1/8"	20	98	8	1
4105-1045	012728	9/64"	22	104	11	1
4105-1005	012735	5/32"	24	110	15	1
4105-1006	012742	3/16"	28	120	23	1
4105-1007	012759	7/32"	30	130	34	1
4105-1008	012766	1/4"	32	141	48	1
4105-1010	012773	5/16"	36	154	83	1
4105-1012	012780	3/8"	40	172	133	1

### 4195 LS/9 LONG METRIC HEXAGON KEY SET WITH BALL-POINT

- Supplied in plastic holder.



ITEM NO.	5704196+	QTY.	SIZE	G	
4195-0009	012537	9	1.5 - 2 - 2.5 - 3 - 4 - 5 - 6 - 8 - 10 mm	356	1

### 4195 LIS/12 LONG INCH HEXAGON KEY SET WITH BALL-POINT

- Supplied in plastic holder.

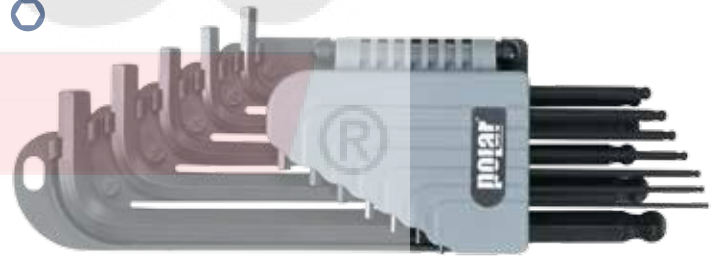

ITEM NO.	5704196+	QTY.	SIZE	G	
4195-1012	012544	12	1/16 - 5/64 - 3/32 - 7/64 - 1/8 - 9/64 - 5/32 - 3/16 - 7/32 - 1/4 - 5/16 - 3/8"	395	1

### 4131 TX LONG KEY FOR TORX® HEAD SCREWS

- Surface: Phosphatised finish. Material: Chrome-vanadium steel.



ITEM NO.	5704196+	TORX® NO.	MM	A MM	L MM	G	
4131-0008	019260	T8	2,31	18	83	6	10
4131-0009	019277	T9	2,5	19	85	7	10
4131-0010	019284	T10	2,74	20	88	7	10
4131-0015	019291	T15	3,27	21	92	8	10
4131-0020	019307	T20	3,86	23	98	12	10
4131-0025	019314	T25	4,43	25	104	18	10
4131-0027	019321	T27	4,99	27	110	19	10
4131-0030	019338	T30	5,52	30	119	28	10
4131-0040	019345	T40	6,65	32	130	40	10
4131-0045	019352	T45	7,82	36	140	67	10
4131-0050	019369	T50	8,83	40	160	78	10

### 4190 LTXS/9 LONG KEY SET FOR TORX® HEAD SCREWS

- Supplied in plastic holder.



ITEM NO.	5704196+	QTY.	SIZE	G	
4190-6009	012551	9	TX T8 - T10 - T15 - T20 - T25 - T27 - T30 - T40 - T50	250	1

## POLAR® SCREWDRIVERS AND BITS



### 4195 FS/8 METRIC HEXAGON KEY SET WITH BALL-POINT

- Compact holder with comfortable grip.



ITEM NO.	5704196+	QTY.	SIZE	G	KG
4195-0008	012506	8	1.5 - 2 - 2.5 - 3 - 4 - 5 - 6 - 8 mm	168	1

### 4190 FTXS/8 KEY SET FOR TORX® HEAD SCREWS

- Compact holder with comfortable grip.



ITEM NO.	5704196+	QTY.	SIZE	G	KG
4190-6008	012520	8	TX.T9 - T10 - T15 - T20 - T25 - T27 - T30 - T40	162	1

### 4195 FIS/8 INCH HEXAGON KEY SET

- Compact holder with comfortable grip.



ITEM NO.	5704196+	QTY.	SIZE	G	KG
4195-1009	012513	9	5/64 - 3/32 - 7/64 - 1/8 - 9/64 - 5/32 - 3/16 - 7/32 - 1/4"	154	1

### 4190 S/30 METRIC AND INCH HEXAGON KEY SET

- Supplied in plast box.

- Content:

15 Metric hexagon keys:

0.7 - 0.9 - 1.3 - 1.5 - 2 - 2.5 - 3 - 4 - 4.5 - 5 - 5.5 - 6 - 7 - 8 - 10 mm

15 Inch hexagon keys:

0.028 - 0.035 - 0.05 - 1/16 - 5/64 - 3/32 - 7/64 - 1/8 - 9/64 - 5/32 - 3/16 - 7/32 - 1/4 - 5/16 - 3/8"



ITEM NO.	5704196+	DIMENSIONS	KG	KG
4190-0030	012568	130 x 190 x 33 mm	0,85	1

# BITS AND -SETS

## 1/4" 1/4" BITS AND ACCESSORIES

### 4514 1/4" BITS FOR SLOTTED HEAD SCREWS

ISO 1173/2351, DIN 3126 C 6,3/3127

- Surface: Sandblasted and oiled. Material: Silicon chrome-vanadium steel.



ITEM NO.	5704196+	A X B MM	L MM	QTY. PCS.	G	24
4514-0035	007120	0,5 x 3,5	25	10	5	24
4514-0045	007137	0,6 x 4,5	25	10	5	24
4514-0055	007144	0,5 x 5,5	25	10	5	24
4514-0065	007151	1,2 x 6,5	25	10	6	24
4514-0080	007168	1,6 x 8	25	10	6	24

### 4514 PH 1/4" BITS FOR PHILLIPS® SCREWS

ISO 1173/8764, DIN 3126 C 6,3/3128

- ACR profile for maximum bite into fasteners.
- Surface: Sandblasted and oiled. Material: Silicon chrome-vanadium steel.



ITEM NO.	5704196+	PH	L MM	QTY. PCS.	G	24
4514-1001	011363	1	25	10	5	24
4514-1002	011370	2	25	10	6	24
4514-1902	015958	2	25	50	6	1
4514-1003	011387	3	25	10	6	24

### 4514 PH R 1/4" BITS FOR PHILLIPS® SCREWS

ISO 1173/8764, DIN 3126 C 6,3/3128

- ACR profile for maximum bite into fasteners.
- Slim model for drywall screws.
- Surface: Sandblasted and oiled. Material: Silicon chrome-vanadium steel.



ITEM NO.	5704196+	PH	L MM	QTY. PCS.	G	24
4514-1502	007205	2	25	10	6	24



## POLAR® SCREWDRIVERS AND BITS



### 4514 PZ 1/4" BITS FOR POZIDRIV® SCREWS

ISO 1173/8764, DIN 3126 C 6,3

- ACR profile for maximum bite into fasteners.
- Surface: Sandblasted and oiled. Material: Silicon chrome-vanadium steel.



ITEM NO.	5704196+	PZ	L MM	QTY. PCS.	G	
4514-2001	011264	1	25	10	5	24
4514-2002	011301	2	25	10	6	24
4514-2902	015965	2	25	50	6	1
4514-2003	011318	3	25	10	6	24

### 4514 STX 1/4" BITS FOR TAMPER RESISTANT® TORX® HEAD SCREWS

ISO 1173, DIN 3126 C 6,3

- Surface: Sandblasted and oiled. Material: Silicon chrome-vanadium steel.



ITEM NO.	5704196+	TORX® NO.	MM	L MM	QTY. PCS.	G	
4514-4009	007359	T9	2,50	25	10	5	24
4514-4010	007366	T10	2,74	25	10	5	24
4514-4015	007373	T15	3,27	25	10	5	24
4514-4020	007380	T20	3,86	25	10	5	24
4514-4025	007397	T25	4,43	25	10	5	24
4514-4027	007403	T27	4,99	25	10	6	24
4514-4030	007410	T30	5,52	25	10	6	24
4514-4040	007427	T40	6,60	25	10	6	24
4514-4045	013732	T45	7,77	25	10	7	24
4514-4050	013749	T50	8,79	25	10	7	24

### 4514 TX 1/4" BITS FOR TORX® HEAD SCREWS

ISO 1173, DIN 3126 C 6,3

- Surface: Sandblasted and oiled. Material: Silicon chrome-vanadium steel.



ITEM NO.	5704196+	TORX® NO.	MM	L MM	QTY. PCS.	G	
4514-4109	015781	T9	2,5	25	10	5	24
4514-4110	015798	T10	2,74	25	10	5	24
4514-4910	015897	T10	2,74	25	50	5	1
4514-4115	015804	T15	3,27	25	10	5	24
4514-4915	015903	T15	3,27	25	50	5	1
4514-4120	015811	T20	3,86	25	10	5	24
4514-4920	015910	T20	3,86	25	50	5	1
4514-4125	015828	T25	4,43	25	10	5	24
4514-4925	015927	T25	4,43	25	50	5	1
4514-4127	015835	T27	4,99	25	10	6	24
4514-4927	015934	T27	4,99	25	50	6	1
4514-4130	015842	T30	5,52	25	10	6	24
4514-4930	015941	T30	5,52	25	50	6	1
4514-4140	015859	T40	6,65	25	10	6	24
4514-4145	015866	T45	7,77	25	10	7	24
4514-4150	015873	T50	8,79	25	10	7	24

### 4514 H 1/4" BITS FOR HEX HEAD SCREWS

ISO 1173/3109, DIN 3126 C 6,3/7426

- Surface: Sandblasted and oiled. Material: Silicon chrome-vanadium steel.



ITEM NO.	5704196+	SIZE MM	L MM	QTY. PCS.	G	
4514-5020	007250	2	25	10	5	24
4514-5030	007274	3	25	10	5	24
4514-5040	007281	4	25	10	5	24
4514-5050	007298	5	25	10	6	24
4514-5060	007304	6	25	10	6	24
4514-5070	011011	7	25	10	6	24
4514-5080	007311	8	25	10	8	24





## POLAR® SCREWDRIVERS AND BITS

### 4590 EC 1/4" BITS SET

ITEM NO. 4590-0024

- Bits set supplied in compact plastic box with 17 pcs. 1/4" bits, 5 pcs. 1/4" magnetic nut setters,
- Quick-Release screwdriver bit socket and accessories.
- 24 tools.

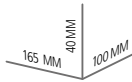

0,47 KG

5704196 014883



CONTENT:

QTY.	DESCRIPTION	SIZE
3	Bits for Phillips® screws	4514 1/4" PH 1 - 2 - 3
1	Bits for Phillips® drywall screws	4514 1/4" PHD 2
1	Bits with reduced head for Phillips® screws	4514 1/4" PHR 2
3	Bits for Pozidriv® screws	4514 1/4" PZ 1 - 2 - 3
6	Bits for Torx® screws	4514 1/4" TX T10 - T15 - T20 - T25 - T30 - T40
3	Bits for square head screws	4514 1/4" SQ 1 - 2 - 3
1	Socket adaptor	4714 1/4 SQ 25 mm
5	Magnetic nut setters	4814 1/4" 8 -10 -11 -13 mm / 1/4"
1	Quick-Release screwdriver bit socket	4714 1/4" QR



24  
TOOLS

### 4590 A 1/4" BITS SET

ITEM NO. 4590-0031

- Bits set supplied in plastic box with 30 pcs. 1/4" bits and Quick-Release screwdriver bit socket.
- 31 tools.

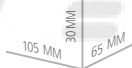

0,24 KG

5704196 000848



CONTENT:

QTY.	DESCRIPTION	SIZE
1	Quick-Release screwdriver bit socket	4714 1/4" QR
5	Bits for slotted head screws	4514 1/4" 3.5 - 4.5 - 5.5 - 6.5 - 8 mm
3	Bits for Phillips® screws	4514 1/4" PH 1 - 2 - 3
3	Bits for Pozidriv® screws	4514 1/4" PZ 1 - 2 - 3
10	Bits for Torx® head screws	4514 1/4" TX T7 - T8 - T9 - T10 - T15 - T20 - T25 - T27 - T30 - T40
7	Bits for hex head screws	4514 1/4" H 2 - 3 - 4 - 5 - 6 - 7 - 8 mm
2	Bits for square head screws	4514 1/4" SQ 1 - 2



31  
TOOLS

### 4590 E 1/4" BITS SET

ITEM NO. 4590-1031

- Bits set supplied in plastic box with 30 pcs. 1/4" bits and Quick-Release screwdriver bit socket.
- 31 tools.

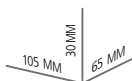

0,24 KG

5704196 017136



CONTENT:

QTY.	DESCRIPTION	SIZE
1	Quick-Release screwdriver bit socket	4714 1/4" QR
3	Bits for Phillips® screws	4514 1/4" PH 2
6	Bits for Pozidriv® screws	4514 1/4" PZ 2
6	Bits for Torx® head screws	4514 1/4" TX T15
6	Bits for Torx® head screws	4514 1/4" TX T20
6	Bits for Torx® head screws	4514 1/4" TX T25
3	Bits for Torx® head screws	4514 1/4" TX T30



31  
TOOLS



## POLAR® SCREWDRIVERS AND BITS



### 4590 B 1/4" BITS SET

ITEM NO. 4590-0056

- Bits set in metal box with 52 pcs. 1/4" bits, magnetic bit holding screwdriver and accessories.
- 56 tools.

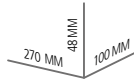

1,06 KG

5704196 000855



**CONTENT:**

QTY.	DESCRIPTION	SIZE
1	Magnetic bit holding screwdriver	4043 1/4" M
1	Quick-Release screwdriver bit socket	4714 1/4" QR
1	Screwdriver bit socket	4714 1/4"
1	Socket adaptor	4714 1/4" SQ 25 mm
5	Bits for slotted head screws	4514 1/4" 3.5 - 4.5 - 5.5 - 6.5 - 8 mm
3	Bits for Phillips® screws	4514 1/4" ACR PH 1 - 2 - 3
3	Bits for Pozidriv® screws	4514 1/4" ACR PZ 1 - 2 - 3
7	Bits for Torx® screws	4514 1/4" TX T10 - T15 - T20 - T25 - T27 - T30 - T40
9	Bits for Tamper Resistant® Torx® head screws	4514 1/4" STX T8 - T9 - T10 - T15 - T20 - T25 - T27 - T30 - T40
7	Bits for hex head bore hole screws	4514 1/4" HB 2 - 2,5 - 3 - 4 - 5 - 6 - 8 mm
1	Bits for square head screws	4514 1/4" SQ 2
5	Bits for Spanner screws	4514 1/4" SN 4 - 6 - 8 - 10 - 12
4	Bits for Torq-Set® screws	4514 1/4" TS 6 - 8 - 10 mm / 1/4"
3	Bits for XZN screws	4514 1/4" XZN 5 - 6 - 8
4	Bits for Tri-Wing® screws	4514 1/4" TW 2 - 3 - 4 - 5
1	Bits for hooks	4514 1/4" HOOK



56  
TOOLS

### 4590 C 1/4" BITS SET

ITEM NO. 4590-0109

- Bits set in metal box with 103 pcs. 1/4" bits, magnetic bit holding screwdriver and accessories.
- 109 tools.



1,47 KG

5704196 000862



**CONTENT:**

QTY.	DESCRIPTION	SIZE
1	Magnetic bit holding screwdriver	4043 1/4" M
1	Magnetic screwdriver bit socket	4714 1/4" M
1	Screwdriver bit socket	4714 1/4"
1	Flexible extension with Quick-Release screwdriver bit socket	4714 1/4" QRF
1	Socket adaptor	4714 1/4" SQ 25 mm
1	Socket adaptor	4714 1/4" SQ 50 mm
6	Bits for slotted head screws	4514 1/4" 3 - 3.5 - 4.5 - 5 - 5.5 - 6.5 mm
5	Bits for Phillips® screws	4514 1/4" PH 0 - 1 - 2 - 3 - 4
3	Bits for Phillips® screws	4514 1/4" ACR PH 1 - 2 - 3
1	Bits with reduced head for Phillips® screws	4514 1/4" PHR 2
5	Bits for Pozidriv® screws	4514 1/4" PZ 0 - 1 - 2 - 3 - 4
3	Bits for Pozidriv® screws	4514 1/4" ACR PZ 1 - 2 - 3
15	Bits for Torx® screws	4514 1/4" TX T5 - T6 - T7 - T8 - T9 - T10 - T15 - T20 - T25 - T27 - T30 - T40 - T45 - T50
11	Bits for Tamper Resistant® Torx® head screws	4514 1/4" STX T6 - T7 - T8 - T9 - T10 - T15 - T20 - T25 - T27 - T30 - T40
10	Bits for hex head screws	4514 1/4" H 1.5 - 2 - 2.5 - 3 - 4 - 5 - 5.5 - 6 - 7 - 8 mm
10	Bits for hex head bore hole screws	4514 1/4" HB 1.5 - 2 - 2.5 - 3 - 4 - 5 - 5.5 - 6 - 7 - 8 mm
6	Bits for hex head bore hole screws	4514 1/4" HB 5/64 - 3/32 - 7/64 - 1/8 - 9/64 - 5/32"
5	Bits for square head screws	4514 1/4" SQ 0 - 1 - 2 - 3 - 4
5	Bits for Spanner screws	4514 1/4" SN 4 - 6 - 8 - 10 - 12
5	Bits for Torq-Set® screws	4514 1/4" TS 4 - 6 - 8 - 10 mm / 1/4"
4	Bits for XZN screws	4514 1/4" XZN 4 - 5 - 6 - 8
5	Bits for Tri-Wing® screws	4514 1/4" TW 1 - 2 - 3 - 4 - 5
3	Bits for Clutch G screws	4514 1/4" CG 1 - 2 - 3
1	Bits for hooks	4514 1/4" HOOK



109  
TOOLS





## POLAR® SCREWDRIVERS AND BITS

### 4590 F 1/4", 3/8" AND 1/2" TORX® SET

ITEM NO. 4590-0035

- Bits and socket wrench set supplied in metal box with Torx® sockets, short and long Torx® bits and accessories.
- 35 tools.

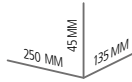

1,9 KG

5704196 017112



35  
TOOLS



**CONTENT:**

QTY.	DESCRIPTION	SIZE
4	Bits for Tamper Resistant® Torx® screws	4514 1/4" STX T9 - T10 - T15 - T20
6	Bits for Tamper Resistant® Torx® screws	4520 10 mm STX T25 - T27 - T30 - T40 - T45 - T50
7	Long bits for Torx® skruer, 75 mm	4520 10 mm TX T25 - T27 - T30 - T40 - T45 - T50 - T55
2	Long bits for Torx® skruer, 75 mm	4524 14 mm TX T60 - T70
5	Sockets for Torx® screws	5014 1/4" NTX E4 - E5 - E6 - E7 - E8
7	Sockets for Torx® screws	5038 3/8" NTX E10 - E11 - E12 - E14 - E16 - E18 - E20
1	Screwdriver bit socket	4714 1/4" x 1/4"
1	Screwdriver bit socket	4738 3/8" x 10 mm
2	Screwdriver bit sockets	4712 1/2" x 10 mm - 1/2" x 14 mm







## POLAR® SCREWDRIVERS AND BITS



### 4590 G 1/4" BITS SET

ITEM NO. 4590-0021

- Bits set supplied in plastic box with 20 pcs. 1/4" bits and Quick-Release screwdriver bit socket.
- 21 tools.



CONTENT:

QTY.	DESCRIPTION	SIZE
1	Quick-Release screwdriver bit socket	4714 1/4" QR
1	Bits for slotted head screws	4514 1/4" 4 mm
1	Bits for slotted head screws	4514 1/4" 5.5 mm
1	Bits for Phillips® screws	4514 1/4" PH 1
3	Bits for Phillips® screws	4514 1/4" PH 2
1	Bits for Phillips® screws	4514 1/4" PH 3
1	Bits for Pozidriv® screws	4514 1/4" PZ 1
3	Bits for Pozidriv® screws	4514 1/4" PZ 2
1	Bits for Pozidriv® screws	4514 1/4" PZ 3
2	Bits for Torx® head screws	4514 1/4" TX T15
2	Bits for Torx® head screws	4514 1/4" TX T20
2	Bits for Torx® head screws	4514 1/4" TX T25
1	Bits for Torx® head screws	4514 1/4" TX T27
1	Bits for Torx® head screws	4514 1/4" TX T30

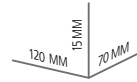

170 G

5704196 018690



21  
TOOLS



### 4614 1/4" BITS FOR SLOTTED HEAD SCREWS

ISO 1173/2351, DIN 3126 E 6,3/3127

- Surface: Sandblasted and oiled. Material: Silicon chrome-vanadium steel.



ITEM NO.	5704196+	A X B MM	L MM	QTY. PCS.	G	Box
4614-0030	011486	0,5 x 3,0	90	10	10	15
4614-0040	011493	0,5 x 4,0	90	10	12	15
4614-0050	011509	0,8 x 5,0	90	10	15	15
4614-0060	011516	1,0 x 6,0	90	10	19	15
4614-0070	011523	1,2 x 7,0	90	10	22	15
4614-0080	011530	1,2 x 8,0	90	10	30	12
4614-0100	011547	1,6 x 10,0	90	10	37	12

### 4614 PZ 1/4" BITS FOR POZIDRIV® SCREWS

ISO 1173/8764, DIN 3126 E 6,3

- ACR profile for maximum bite into fasteners.
- Surface: Sandblasted and oiled. Material: Silicon chrome-vanadium steel.



ITEM NO.	5704196+	PZ	L MM	QTY. PCS.	G	Box
4614-2001	011462	1	90	10	14	15
4614-2002	011226	2	90	10	17	15
4614-2003	011479	3	90	10	20	15

### 4614 PH 1/4" BITS FOR PHILLIPS® SCREWS

ISO 1173/8764, DIN 3126 E 6,3/3128

- ACR profile for maximum bite into fasteners.
- Surface: Sandblasted and oiled. Material: Silicon chrome-vanadium steel.



ITEM NO.	5704196+	PH	L MM	QTY. PCS.	G	Box
4614-1001	011448	1	90	10	14	15
4614-1002	011219	2	90	10	17	15
4614-1003	011455	3	90	10	20	15

### 4614 STX 1/4" BITS FOR TAMPER RESISTANT® TORX® SCREWS

ISO 1173, DIN 3126 E 6,3

- Surface: Sandblasted and oiled. Material: Silicon chrome-vanadium steel.



ITEM NO.	5704196+	TORX® NO.	MM	L MM	QTY. PCS.	G	Box
4614-4010	011554	T10	2,72	90	12	10	15
4614-4015	011561	T15	3,26	90	13	10	15
4614-4020	011578	T20	3,84	90	15	10	15
4614-4025	011585	T25	4,40	90	19	10	15
4614-4027	011592	T27	4,96	90	21	10	15
4614-4030	011608	T30	5,49	90	22	10	15
4614-4040	011615	T40	6,60	90	24	10	15



## POLAR® SCREWDRIVERS AND BITS

### 4714 QR 1/4" QUICK-RELEASE SCREWDRIVER BIT SOCKET

- Magnetic model with quick-release and locking pin.
- Surface: Chrome plated finish with burnished ring.
- Material: Chrome-vanadium steel.



ITEM NO.	5704196+	Ø	A MM	L MM	G	☒
4714-2014	015408	1/4"	11,5	50	25	20

### 4714 SQ 1/4" SOCKET WRENCH ADAPTORS

- Model with retaining ball.
- Surface: Sandblasted and oiled. Material: Silicon chrome-vanadium steel.



ITEM NO.	5704196+	Ø	Hex	L MM	G	☒
4714-4014	015439	1/4"	1/4"	25	7	30
4714-4114	015446	1/4"	1/4"	50	14	20
4714-4138	015453	3/8"	1/4"	50	20	20
4714-4112	015767	1/2"	1/4"	50	33	20

### 4714 QRF 1/4" FLEXIBLE EXTENSION WITH QUICK-RELEASE SCREWDRIVER BIT SOCKET

- Maximum torque allowed: 2,8 Nm.
- Surface: Chrome plated finish with burnished ring.
- Material: Chrome-vanadium steel.



ITEM NO.	5704196+	Ø	A MM	L MM	G	☒
4714-2114	019031	1/4"	14	175	80	10

### 4814 1/4" MAGNETIC NUT SETTERS

- Surface: Sandblasted and oiled. Material: Silicon chrome-vanadium steel.



ITEM NO.	5704196+	Ø	Hex	L MM	G	☒
4814-5008	015729	8 mm	1/4"	65	31	20
4814-5010	015736	10 mm	1/4"	65	37	20
4814-5011	015743	11 mm	1/4"	65	42	20
4814-5013	015750	13 mm	1/4"	65	52	20
4814-5014	018591	1/4"	1/4"	65	30	20

### 4714 M 1/4" MAGNETIC SCREWDRIVER BIT SOCKET

- Surface: Chrome plated finish with burnished ring.
- Material: Chrome-vanadium steel.



ITEM NO.	5704196+	Ø	A MM	L MM	G	☒
4714-3014	015415	1/4"	11,5	50	25	20

### 4714 MC 1/4" MAGNETIC SCREWDRIVER BIT SOCKET WITH C-RING

- Surface: Chrome plated finish with burnished ring.
- Material: Chrome-vanadium steel.



ITEM NO.	5704196+	Ø	A MM	L MM	G	☒
4714-3114	015422	1/4"	10	60	24	20

### 5/16" 5/16" BITS AND ACCESSORIES

#### 4516 5/16" BITS FOR SLOTTED HEAD SCREWS

ISO 1173/2351, DIN 3126 C 8/3127

- Surface: Sandblasted and oiled. Material: Silicon chrome-vanadium steel.



ITEM NO.	5704196+	A X B MM	L MM	QTY. PCS.	G	☒
4516-0080	013725	1,2 x 8	30	10	10	24
4516-0100	010984	1,6 x 10	30	5	18	24
4516-0120	010991	1,8 x 12	30	5	20	24

#### 4516 PH 5/16" BITS FOR PHILLIPS® SCREWS

ISO 1173/8764, DIN 3126 C 8/3128

- ACR profile for maximum bite into fasteners.

- Surface: Sandblasted and oiled. Material: Silicon chrome-vanadium steel.



ITEM NO.	5704196+	PH	L MM	QTY. PCS.	G	☒
4516-1002	013657	2	30	10	9	24
4516-1003	013664	3	30	10	10	24
4516-1004	011394	4	30	10	16	24





## POLAR® SCREWDRIVERS AND BITS



### 4516 PZ 5/16" BITS FOR POZIDRIV® SCREWS

ISO 1173/8764, DIN 3126 C 8

- ACR profile for maximum bite into fasteners.
- Surface: Sandblasted and oiled. Material: Silicon chrome-vanadium steel.



ITEM NO.	5704196+	PZ	L MM	QTY. PCS.	G	
4516-2002	013756	2	30	10	9	24
4516-2003	013763	3	30	10	10	24
4516-2004	011325	4	30	10	16	24

### 4712 1/2" IMPACT SCREWDRIVER BIT SOCKET

ISO 1173-1174, DIN 7427.

- For use with 5/16" screwdriver bits.
- Surface: Phosphatised finish. Material: Chrome-vanadium steel.

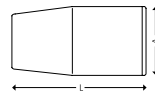

ITEM NO.	5704196+	5/16"	1/2"	A MM	L MM	G	
4712-6012	013701			22	38	63	1

### 4516 TX 5/16" BITS FOR TORX® HEAD SCREWS

ISO 1173, DIN 3126 C 8

- Surface: Sandblasted and oiled. Material: Silicon chrome-vanadium steel.



ITEM NO.	5704196+	TORX® NO.	MM	L MM	QTY. PCS.	G	
4516-4040	010939	T40	6,65	30	10	12	24
4516-4045	010946	T45	7,82	30	10	13	24
4516-4050	010953	T50	8,83	30	10	14	24
4516-4055	010960	T55	11,22	30	5	20	24

### 4712 ID 1/2" IMPACT BIT DRIVER

- For fast and safe loosening of locked, rusted or glued screws.
- Torque: 400 Nm. Driving direction can be adjusted by turning the grip.
- Surface: Phosphatised. Material: Chrome-vanadium steel.

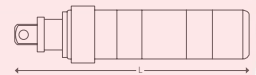

ITEM NO.	5704196+	1/2"	A MM	L MM	G	
4712-6112	013718		31	143	660	1

### 4516 H 5/16" BITS FOR HEX HEAD SCREWS

ISO 1173/3109, DIN 3126 C 8/7426

- Surface: Sandblasted and oiled. Material: Silicon chrome-vanadium steel.



ITEM NO.	5704196+	SIZE MM	L MM	QTY. PCS.	G	
4516-5005	013671	5	30	10	10	24
4516-5006	013688	6	30	10	11	24
4516-5008	013695	8	30	10	13	24
4516-5010	010915	10	30	5	17	24
4516-5012	010922	12	30	5	22	24

### 4790 1/2" IMPACT BIT DRIVER SET

ITEM NO. 4790-0015



- Set supplied in plastic box with 5/16" bits (13 pcs.), bits socket and impact bit driver. 15 tools.

CONTENT:

QTY.	DESCRIPTION	SIZE
3	Bits for slotted head screws	4516 5/16" 8, 10, 12 mm
3	Bits for Phillips® screws	4516 5/16" ACR PH 2 - 3 - 4
4	Bits for Torx® screws	4516 5/16" TX T40 - T45 - T50 - T55
3	Bits for hex head screws	4516 5/16" H 5 - 6 - 8 mm
1	Screwdriver bit socket	4712 1/2" x 5/16"
1	Impact bit driver	4712 1/2 ID

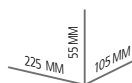

1,0 KG

5704196 013640

1





## POLAR® SOCKETS AND ACCESSORIES

# SOCKETS & ACCESSORIES

*POLAR® sockets and ratchets are designed to fit and built to perform for a lifetime.  
Made from high grade chrome vanadium steel for a stronger and more durable tool.*

- 1/4" Sockets, socket bits, ratchets and accessories
- 3/8" Sockets, ratchets and accessories
- 1/2" Sockets, socket bits, ratchets and accessories
- 3/4" Sockets, ratchets and accessories





# POLAR® SOCKETS AND ACCESSORIES



6-Point



12-Point



Slotted



Phillips®



Pozidriv®



Torx®



Tamper resist Torx®  
Tel: (+974) 443 54 298  
www.boltsandtools.com



Torx®



Hexagon



Bit driver  
Tel: (+974) 443 54 298  
www.boltsandtools.com

# POLAR® SOCKETS AND ACCESSORIES



## 1/4" 1/4" SOCKETS AND ACCESSORIES

### 5014 1/4" 6-POINT METRIC SOCKETS

ISO 2725-1, DIN 3124

■ Surface: Satin chrome finish. Material: Chrome-vanadium steel.

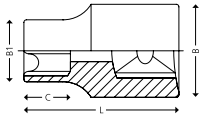

ITEM NO.	5704196+	SIZE MM	B MM	B1 MM	C MM	L MM	G	
5014-0004	000923	4	11,9	6,8	5	25	10	10
5014-0045	000930	4,5	11,9	7,1	5	25	10	10
5014-0005	000947	5	11,9	8,0	5	25	10	10
5014-0055	000954	5,5	11,9	8,3	5	25	10	10
5014-0006	000961	6	11,9	9,3	5	25	11	10
5014-0007	000978	7	11,9	10,5	5	25	12	10
5014-0008	000985	8	11,9	11,9	5	25	12	10
5014-0009	000992	9	13,0	13,0	8	25	12	10
5014-0010	001005	10	14,0	14,0	8	25	22	10
5014-0011	001012	11	15,9	15,9	8	25	24	10
5014-0012	001029	12	16,9	16,9	8	25	27	10
5014-0013	001036	13	17,8	17,8	10	25	31	10
5014-0014	001043	14	19,6	19,6	10	25	38	10

### 5014 1/4" 6-POINT INCH SOCKETS

ANSI B107.1

■ Surface: Satin chrome finish. Material: Chrome-vanadium steel.

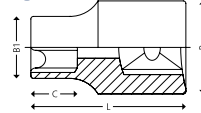

ITEM NO.	5704196+	SIZE "	B MM	B1 MM	C MM	L MM	G	
5014-1005	001050	5/32"	11,9	6,8	5	25	10	10
5014-1006	001067	3/16"	11,9	8,0	5	25	10	10
5014-1007	001074	7/32"	11,9	8,8	5	25	11	10
5014-1008	001081	1/4"	11,9	9,3	5	25	11	10
5014-1009	001098	9/32"	11,9	10,5	5	25	12	10
5014-1010	001104	5/16"	11,9	11,9	5	25	12	10
5014-1011	001111	11/32"	13,0	13,0	5	25	19	10
5014-1012	001128	3/8"	14,0	14,0	8	25	22	10
5014-1013	001135	13/32"	14,0	14,0	8	25	24	10
5014-1014	001142	7/16"	16,0	16,0	8	25	24	10
5014-1016	001159	1/2"	17,8	17,8	10	25	31	10

### 5014 L 1/4" 6-POINT LONG METRIC SOCKETS

ISO 2725-1, DIN 3124

■ Surface: Satin chrome finish. Material: Chrome-vanadium steel.

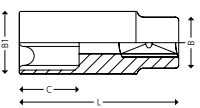

ITEM NO.	5704196+	SIZE MM	B MM	B1 MM	C MM	L MM	G	
5014-4004	001166	4	11,9	6,8	5	50	22	10
5014-4005	001173	5	11,9	8,0	5	50	21	10
5014-4055	001180	5,5	11,9	8,3	5	50	21	10
5014-4006	001197	6	11,9	9,3	8	50	22	10
5014-4007	001203	7	11,9	10,5	8	50	23	10
5014-4008	001210	8	11,9	11,9	8	50	25	10
5014-4009	001227	9	13,2	13,2	11	50	30	10
5014-4010	001234	10	14,6	14,6	11	50	40	10
5014-4011	001241	11	15,9	15,9	11	50	56	10
5014-4012	001258	12	17,0	17,0	13	50	53	10
5014-4013	001265	13	18,0	18,0	13	50	70	10

### 5014 NTX 1/4" SOCKETS FOR TORX® SCREWS

ANSI B107.1

■ Surface: Satin chrome finish. Material: Chrome-vanadium steel.

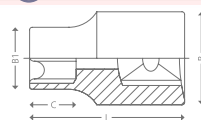

ITEM NO.	5704196+	TORX® NO	MM	B MM	B1 MM	C MM	L MM	G	
5014-6004	001494	E4	3,86	12,0	6,9	5	25	12	10
5014-6005	001500	E5	4,75	12,0	8,1	5	25	12	10
5014-6006	001517	E6	5,74	12,0	8,8	5	25	13	10
5014-6007	001524	E7	6,22	12,0	9,6	6	25	14	10
5014-6008	001531	E8	7,52	12,0	10,6	7	25	13	10
5014-6010	001548	E10	9,42	14,7	13,3	8	25	21	10





# POLAR® SOCKETS AND ACCESSORIES



## 5114 1/4" SOCKET DRIVERS FOR SLOTTED HEAD SCREWS

ISO 2380, DIN 5264

■ Surface: Satin chrome finish. Material: Chrome-vanadium steel.

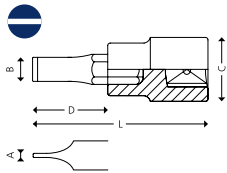

ITEM NO.	5704196+	A X B MM	C MM	D MM	L MM	G	Icon
5114-3004	001272	0,6 x 4	18	11,9	37	14	10
5114-3007	001296	1,2 x 7	11,9	18	37	15	10
5114-3055	001289	08 x 5,5	11,9	18	37	14	10

## 5114 H 1/4" SOCKET DRIVERS FOR HEX HEAD SCREWS

DIN 7422

■ Surface: Satin chrome finish. Material: Chrome-vanadium steel.

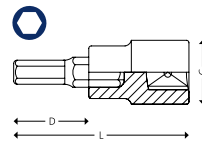

ITEM NO.	5704196+	SIZE MM	C MM	D MM	L MM	G	Icon
5114-2003	001364	3	11,9	18	37	14	10
5114-2004	001371	4	11,9	18	37	14	10
5114-2045	019505	4,5	11,9	18	37	15	10
5114-2005	001388	5	11,9	18	37	15	10
5114-2055	019512	5,5	11,9	18	37	16	10
5114-2006	001395	6	11,9	18	37	16	10
5114-2007	001401	7	11,9	18	37	16	10
5114-2008	001418	8	11,9	18	37	17	10

## 5114 PH 1/4" SOCKET DRIVERS FOR PHILLIPS® HEAD SCREWS

ISO 8764

■ Surface: Satin chrome finish. Material: Chrome-vanadium steel.

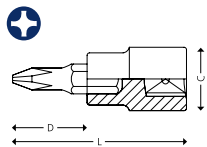

ITEM NO.	5704196+	PH	C MM	D MM	L MM	G	Icon
5114-3101	001302	1	11,9	18	37	14	10
5114-3102	001319	2	11,9	18	37	14	10
5114-3103	001326	3	11,9	18	37	15	10

## 5114 STX 1/4" SOCKET DRIVERS FOR TAMPER RESIST® TORX® SCREWS

■ Surface: Satin chrome finish. Material: Chrome-vanadium steel.

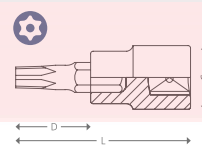

ITEM NO.	5704196+	TORX® NO	MM	C MM	D MM	L MM	G	Icon
5114-1510	001425	T10	2,74	11,9	18	37	14	10
5114-1515	001432	T15	3,27	11,9	18	37	14	10
5114-1520	001449	T20	3,86	11,9	18	37	14	10
5114-1525	001456	T25	4,43	11,9	18	37	14	10
5114-1527	001463	T27	4,99	11,9	18	37	14	10
5114-1530	001470	T30	5,52	11,9	18	37	14	10
5114-1540	001487	T40	6,65	11,9	18	37	15	10

## 5114 PZ 1/4" SOCKET DRIVERS FOR POZIDRIV® HEAD SCREWS

ISO 8764

■ Surface: Satin chrome finish. Material: Chrome-vanadium steel.

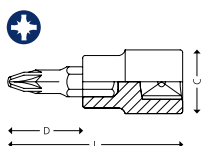

ITEM NO.	5704196+	PZ	C MM	D MM	L MM	G	Icon
5114-3201	001333	1	11,9	18	37	14	10
5114-3202	001340	2	11,9	18	37	15	10
5114-3203	001357	3	11,9	18	37	15	10

## 4714 1/4" SCREWDRIVER BIT SOCKET

ISO 1173-1174, DIN 3126.

■ For use with 1/4" screwdriver bits.

■ Surface: Satin chrome finish. Material: Chrome-vanadium steel.

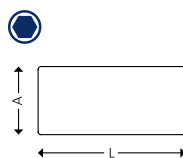

ITEM NO.	5704196+	Icon	A MM	L MM	G	Icon
4714-5014	001555	1/4"	12	25	14	10



## POLAR® SOCKETS AND ACCESSORIES

### 5214 EX 1/4" EXTENSIONS

ISO 3316, DIN 3123.

- With ext. 11 mm hexagon.
- Surface: Satin chrome finish. Material: Chrome-vanadium steel.

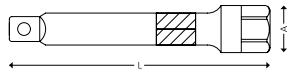

ITEM NO.	5704196+	L MM	A MM	G	10
5214-0050	001562	50	12	26	10
5214-0100	001579	100	12	48	10
5214-0150	001586	150	12	70	10

### 5414 TH 1/4" SLIDING T-HANDLE

ISO 3315, DIN 3122

- Surface: Satin chrome finish. Material: Chrome-vanadium steel.

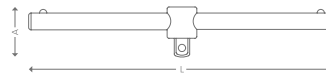

ITEM NO.	5704196+	L MM	A MM	G	10
5414-0014	001623	115	24	42	10

### 5214 F 1/4" FLEXIBLE EXTENSION

- Maximum torque allowed: 2,8 Nm.
- Surface: Chrome plated finish. Material: Chrome-vanadium steel.

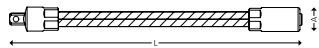

ITEM NO.	5704196+	L MM	A MM	G	10
5214-1150	001593	150	12	62	10

### 5814 U 1/4" UNIVERSAL JOINT

ISO 3316, DIN 3123

- Equipped with tension-spring. Joint stays at desired angle.
- Surface: Satin chrome finish. Material: Chrome-vanadium steel.

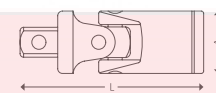

ITEM NO.	5704196+	L MM	A MM	G	10
5814-0014	001616	38	14	27	10

### 5614 A 1/4" ADAPTOR FROM 1/4" TO 3/8"

ISO 3316, DIN 3123

- Surface: Satin chrome finish. Material: Chrome-vanadium steel.

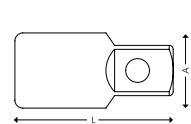

ITEM NO.	5704196+	1/4"	3/8"	A MM	L MM	G	10
5614-1438	001609	1/4"	3/8"	14	25,5	32	10

### 5514 HD 1/4" PLASTIC HANDLE DRIVER

ISO 3315, DIN 3122

- Handle with internal 1/4" square drive.
- Surface: Satin chrome finish. Material: Chrome-vanadium steel.

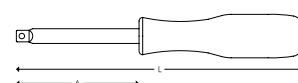

ITEM NO.	5704196+	L MM	A MM	G	10
5514-0014	001630	150	62	100	10





### 5314 A 1/4" REVERSIBLE RATCHET W/ LOCKING SYSTEM

ISO 3315, DIN 3122.

- Model with 60 teeth and Quick Release. Compact head with working angle of 6°.
- Surface: Satin chrome finish. Material: Chrome-vanadium steel.

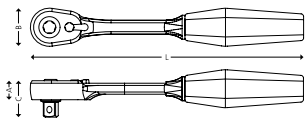

ITEM NO.	5704196+	A MM	B MM	C MM	L MM	G	
5314-0060	017174	10,5	20	20	143	90	1

### 5314 B 1/4" REVERSIBLE RATCHET W/ LOCKING SYSTEM

ISO 3315, DIN 3122

- Model with 48 teeth and Quick Release. Compact head with working angle of 7,5°.
- Surface: Satin chrome finish. Material: Chrome-vanadium steel.

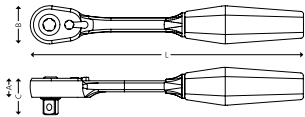
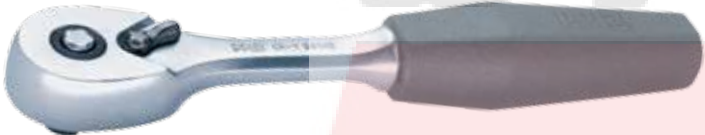

ITEM NO.	5704196+	A MM	B MM	C MM	L MM	G	
5314-0048	015712	11,4	25	20	140	116	1

### 5314 C 1/4" REVERSIBLE RATCHET W/ LOCKING SYSTEM

ISO 3315, DIN 3122

- Model with 72 teeth and Quick Release. Compact head with working angle of 5°.
- Surface: Satin chrome finish. Material: Chrome-vanadium steel.

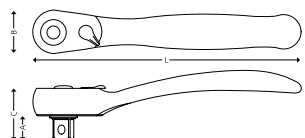

ITEM NO.	5704196+	A MM	B MM	C MM	L MM	G	
5314-1072	020006	8,5	17,7	15,8	95	54	1



# POLAR® SOCKETS AND ACCESSORIES

## 3/8" 3/8" SOCKETS AND ACCESSORIES

### 5038 3/8" 6-POINT METRIC SOCKETS

ISO 2725-1, DIN 3124

■ Surface: Satin chrome finish. Material: Chrome-vanadium steel.

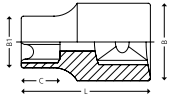

ITEM NO.	5704196+	SIZE MM	B MM	B1 MM	C MM	L MM	G	
5038-0006	001654	6	17,0	10,2	8	28	22	10
5038-0007	001661	7	17,0	10,6	8	28	22	10
5038-0008	001678	8	17,0	11,8	8	28	24	10
5038-0009	001685	9	17,0	13,2	8	28	24	10
5038-0010	001692	10	17,0	14,5	8	28	25	10
5038-0011	001708	11	17,0	15,7	8	28	24	10
5038-0012	001715	12	16,0	17,0	8	28	23	10
5038-0013	001722	13	16,5	18,0	8	28	27	10
5038-0014	001739	14	17,0	19,6	12	28	34	10
5038-0015	001746	15	18,0	20,9	12	28	41	10
5038-0016	001753	16	19,0	22,0	12	30	43	10
5038-0017	001760	17	20,0	23,4	12	30	54	10
5038-0018	001777	18	21,0	24,6	12	30	60	10
5038-0019	001784	19	23,0	26,0	14	30	68	10
5038-0020	001791	20	24,0	27,1	14	32	81	10
5038-0021	001807	21	25,0	28,0	14	32	83	10
5038-0022	001814	22	26,0	29,6	14	32	99	10

### 5038 3/8" 6-POINT INCH SOCKETS

ANSI B107.1

■ Surface: Satin chrome finish. Material: Chrome-vanadium steel.

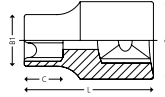

ITEM NO.	5704196+	SIZE MM	B MM	B1 MM	C MM	L MM	G	
5038-1008	001821	1/4"	17,0	10,2	8	28	22	10
5038-1010	001838	5/16"	17,0	11,8	8	28	24	10
5038-1012	001845	3/8"	17,0	14,5	8	28	25	10
5038-1014	001852	7/16"	16,0	15,7	8	28	24	10
5038-1016	001869	1/2"	17,0	18,0	8	28	27	10
5038-1018	001883	9/16"	18,0	19,6	12	28	34	10
5038-1019	001890	19/32"	19,0	21,8	12	30	41	10
5038-1020	001906	5/8"	20,0	22,0	12	30	43	10
5038-1022	001913	11/16"	23,0	23,4	12	30	54	10
5038-1024	001920	3/4"	24,0	26,0	14	32	68	10
5038-1026	001937	13/16"	26,0	28,0	14	32	83	10
5038-1028	001944	7/8"	27,0	29,6	14	32	99	10

### 5038 L 3/8" 6-POINT LONG METRIC SOCKETS

ISO 2725-1, DIN 3124

■ Surface: Satin chrome finish. Material: Chrome-vanadium steel.

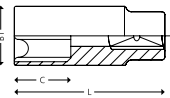

ITEM NO.	5704196+	SIZE MM	B MM	B1 MM	C MM	L MM	G	
5038-4008	001951	8	17,0	11,8	9	63	51	10
5038-4009	001968	9	17,0	13,2	9	63	53	10
5038-4010	001975	10	17,0	14,5	9	63	56	10
5038-4011	001982	11	17,0	15,7	12	63	62	10
5038-4012	001999	12	16,0	17,0	12	63	70	10
5038-4013	002002	13	16,5	18,0	12	63	76	10
5038-4014	002019	14	17,0	19,6	15	63	86	10
5038-4015	002026	15	18,0	20,9	15	63	111	10
5038-4016	002033	16	19,0	22,0	15	63	101	10
5038-4017	002040	17	20,0	23,4	15	63	122	10
5038-4018	002057	18	21,0	24,6	18	63	153	10
5038-4019	002064	19	23,0	26,0	18	63	142	10
5038-4021	002071	21	25,0	28,0	18	63	160	10
5038-4022	002088	22	26,0	29,6	21	63	195	10

### 5038 SP 3/8" SPARK PLUG SOCKETS

ISO 11168

■ Rubber gasket for retaining the spark plug.  
■ Surface: Satin chrome finish. Material: Chrome-vanadium steel.

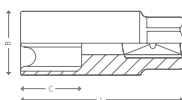

ITEM NO.	5704196+	SIZE MM	MM	B MM	L MM	G	
5038-0516	002095	16	19	22	63	91	10
5038-0518	015682	18	22	24,5	63	118	10
5038-0521	002101	21	22	27,5	63	127v	10

### 5238 EX 3/8" EXTENSIONS

■ ISO 3316, DIN 3123.  
■ With ext. 16 mm Hexagon.  
■ Surface: Chrome plated finish. Material: Chrome-vanadium steel.

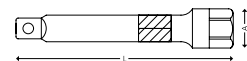

ITEM NO.	5704196+	L MM	A MM	G	
5238-0075	002118	75	18	830	10
5238-0150	002132	150	18	155	10
5238-0250	002149	250	18	244	10



# POLAR® SOCKETS AND ACCESSORIES



## 5238 EXW 3/8" WOBBLE EXTENSIONS

- Can be used for both wobble and rigid functionality.
- The wobble function provides 15° of additional accessibility.
- With ext. 16 mm Hexagon.
- Surface: Chrome plated finish. Material: Chrome-vanadium steel.

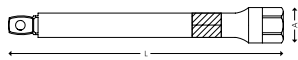

ITEM NO.	5704196+	L MM	A MM	G	10
5238-1075	011028	75	18	83	10
5238-1150	011035	150	18	155	10
5238-1250	011042	250	18	244	10
5238-1450	011059	450	18	630	10

## 5438 TH 3/8" SLIDING T-HANDLE

- ISO 3315, DIN 3122
- Surface: Satin chrome finish. Material: Chrome-vanadium steel.

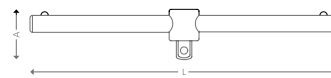

ITEM NO.	5704196+	L MM	A MM	G	10
5438-0038	002187	164	34	43	10

## 5738 A 3/8" ADAPTOR FROM 3/8" TO 1/4"

- ISO 3316, DIN 3123
- Surface: Satin chrome finish. Material: Chrome-vanadium steel.

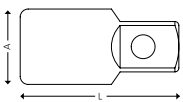

ITEM NO.	5704196+	□	■	A MM	L MM	G	10
5738-3814	002156	3/8"	1/4"	16	27	30	10

## 5838 U 3/8" UNIVERSAL JOINT

- ISO 3316, DIN 3123
- Equipped with tension-spring. Joint stays at desired angle.
- Surface: Satin chrome finish. Material: Chrome-vanadium steel.



ITEM NO.	5704196+	L MM	A MM	G	10
5838-0038	002170	56	20	67	10

## 5638 A 3/8" ADAPTOR FROM 3/8" TO 1/2"

- ISO 3316, DIN 3123
- Surface: Satin chrome finish. Material: Chrome-vanadium steel.

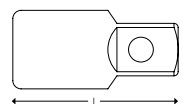

ITEM NO.	5704196+	□	■	A MM	L MM	G	10
5638-3812	002163	3/8"	1/2"	16	37,5	69	10



## 5338 3/8" REVERSIBLE RATCHET WITH LOCKING SYSTEM

- ISO 3315, DIN 3122
- Model with 72 teeth and Quick Release.
- Compact head with working angle of 5°.
- Surface: Satin chrome finish. Material: Chrome-vanadium steel.

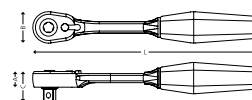

ITEM NO.	5704196+	A MM	B MM	C MM	L MM	G	10
5338-0072	002194	13,3	26,6	27,2	196	220	1



# POLAR® SOCKETS AND ACCESSORIES



## 1/2" 1/2" SOCKETS AND ACCESSORIES

### 5012 1/2" 6-POINT METRIC SOCKETS

ISO 2725-1, DIN 3124

■ Surface: Satin chrome finish. Material: Chrome-vanadium steel.

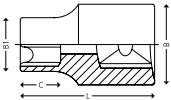

ITEM NO.	5704196+	SIZE MM	B MM	B1 MM	C MM	L MM	G	
5012-0008	002200	8	21,8	13,2	12	38	47	10
5012-0009	002217	9	21,8	13,9	12	38	47	10
5012-0010	002224	10	21,8	15,0	12	38	49	10
5012-0011	002231	11	21,8	16,3	12	38	50	10
5012-0012	002248	12	21,8	17,6	12	38	50	10
5012-0013	002255	13	21,8	18,8	12	38	51	10
5012-0014	002262	14	21,8	20,4	21	38	53	10
5012-0015	002279	15	20,7	21,6	12	38	54	10
5012-0016	002286	16	21,5	22,9	12	38	61	10
5012-0017	002293	17	22,0	24,0	12	38	68	10
5012-0018	002309	18	23,0	25,4	12	38	85	10
5012-0019	002316	19	23,0	26,0	14	38	73	10
5012-0020	002323	20	24,0	27,9	14	38	86	10
5012-0021	002330	21	25,0	28,0	14	38	82	10
5012-0022	002347	22	26,0	30,0	14	40	106	10
5012-0023	002354	23	27,0	31,6	14	40	125	10
5012-0024	002361	24	28,0	32,0	16	42	121	10
5012-0025	002378	25	30,0	34,0	16	42	150	10
5012-0026	002385	26	30,0	35,4	16	42	170	10
5012-0027	002392	27	30,0	36,0	18	43	168	10
5012-0028	002408	28	32,0	37,9	18	43	193	10
5012-0029	002415	29	32,0	38,0	20	43	205	10
5012-0030	002422	30	34,0	40,0	22	46	225	10
5012-0032	002439	32	36,0	42,0	22	46	255	10

### 5012 L 1/2" 6-POINT LONG METRIC SOCKETS

ISO 2725-1, DIN 3124

■ Surface: Satin chrome finish. Material: Chrome-vanadium steel.

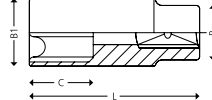

ITEM NO.	5704196+	SIZE MM	B MM	B1 MM	C MM	L MM	G	
5012-4010	002835	10	22,0	15,0	12	77	96	10
5012-4011	002842	11	22,0	16,3	12	77	101	10
5012-4012	002859	12	22,0	17,6	12	77	107	10
5012-4013	002866	13	22,0	18,8	12	77	109	10
5012-4014	002873	14	22,0	20,4	15	77	112	10
5012-4015	002880	15	20,7	21,6	15	77	109	10
5012-4016	002897	16	21,5	22,9	15	77	112	10
5012-4017	002903	17	22,0	24,0	15	77	133	10
5012-4018	002910	18	23,0	25,4	18	77	179	10
5012-4019	002927	19	23,0	26,0	18	77	157	10
5012-4020	002934	20	24,0	27,9	18	77	210	10
5012-4021	002941	21	25,0	28,0	18	77	222	10
5012-4022	002958	22	26,0	30,0	21	77	227	10
5012-4024	002965	24	28,0	32,0	24	77	255	10

### 5012 B 1/2" 12-POINT METRIC SOCKETS

ISO 2725-1, DIN 3124

■ Surface: Satin chrome finish. Material: Chrome-vanadium steel.

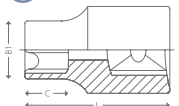

ITEM NO.	5704196+	SIZE MM	B MM	B1 MM	C MM	L MM	G	
5012-2010	002613	10	21,8	15,0	12	38	49	10
5012-2011	002620	11	21,8	16,3	12	38	50	10
5012-2012	002637	12	21,8	17,6	12	38	50	10
5012-2013	002644	13	21,8	18,8	12	38	51	10
5012-2014	002651	14	21,8	20,4	12	38	53	10
5012-2015	002668	15	20,7	21,6	12	38	54	10
5012-2016	002675	16	21,5	22,9	12	38	61	10
5012-2017	002682	17	22,0	24,0	12	38	68	10
5012-2018	002699	18	23,0	25,4	12	38	85	10
5012-2019	002705	19	23,0	26,0	14	38	73	10
5012-2020	002712	20	24,0	27,9	14	38	86	10
5012-2021	002729	21	25,0	28,0	14	38	82	10
5012-2022	002736	22	26,0	30,0	14	40	106	10
5012-2023	002743	23	27,0	31,6	14	40	125	10
5012-2024	002750	24	28,0	32,0	16	42	121	10
5012-2025	002767	25	30,0	34,0	16	42	150	10
5012-2026	002774	26	30,0	35,4	16	42	170	10
5012-2027	002781	27	30,0	36,0	18	43	168	10
5012-2028	002798	28	32,0	37,9	18	43	193	10
5012-2029	002804	29	32,0	38,0	20	43	205	10
5012-2030	002811	30	34,0	40,0	22	46	225	10
5012-2032	002828	32	36,0	42,0	22	46	255	10





# POLAR® SOCKETS AND ACCESSORIES



## 5012 1/2" 6-POINT INCH SOCKETS

ANSI B107.1

- Surface: Satin chrome finish. Material: Chrome-vanadium steel.

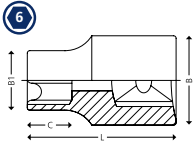

## 5012 NTX 1/2" SOCKETS FOR TORX® SCREWS

- Surface: Satin chrome finish. Material: Chrome-vanadium steel.

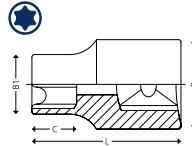

ITEM NO.	5704196+	SIZE	B	B1	C	L	G	
		"	MM	MM	MM	MM	MM	
5012-1012	002446	3/8"	21,8	15,0	12	38	49	10
5012-1014	002453	7/16"	21,8	16,3	12	38	50	10
5012-1016	002460	1/2"	21,8	18,8	12	38	51	10
5012-1018	002477	9/16"	21,8	20,4	12	38	53	10
5012-1019	002484	19/32"	20,7	21,6	12	38	54	10
5012-1020	002491	5/8"	21,5	22,9	12	38	61	10
5012-1022	002507	11/16"	22,0	24,0	12	38	68	10
5012-1024	002514	3/4"	23,0	26,0	14	38	73	10
5012-1025	002521	25/32"	24,0	27,9	14	38	86	10
5012-1026	002538	13/16"	25,0	28,0	14	38	82	10
5012-1028	002545	7/8"	26,0	30,0	14	40	106	10
5012-1030	002552	15/16"	28,0	32,0	16	42	121	10
5012-1032	002569	1"	30,0	34,0	16	42	150	10
5012-1034	002576	1 1/16"	30,0	36,0	18	43	168	10
5012-1036	002583	1 1/8"	32,0	38,0	20	43	205	10
5012-1038	002590	1 3/16"	34,0	40,0	22	46	225	10
5012-1040	002606	1 1/4"	36,0	42,0	22	46	225	10

ITEM NO.	5704196+	TORX® NO.	MM	B	B1	C	L	G	
			MM	MM	MM	MM	MM	MM	
5012-6010	002972	E10	9,42	22,0	13,5	7	38	52	10
5012-6011	010793	E11	9,80	22,0	14,0	8	38	53	10
5012-6012	002989	E12	11,17	22,0	15,0	8	38	57	10
5012-6014	002996	E14	12,90	22,0	17,0	9	38	63	10
5012-6016	003009	E16	14,76	22,0	19,0	10	38	57	10
5012-6018	003016	E18	16,70	24,0	21,0	12	38	72	10
5012-6020	003023	E20	18,45	22,0	24,0	13	38	80	10
5012-6022	010809	E22	20,00	23,0	26,0	14	38	95	10
5012-6024	003030	E24	22,16	24,0	28,0	16	38	114	10



## 5090 NTX 1/2" SOCKET SET FOR TORX® SCREWS

ITEM NO. 5090-1207

- Set in metal box with Torx® sockets from E10 to E24.
- 7 tools.

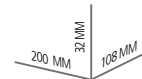

0,9 KG

5704196 000701

1

7  
TOOLS



CONTENT:

QTY.	DESCRIPTION	SIZE
7	Sockets for Torx® screws	5112 1/2" NTX E10 - E12 - E14 - E16 - E18 - E20 - E24



**POLAR®**

### 5112 1/2" SOCKET DRIVERS FOR SLOTTED HEAD SCREWS

ISO 2380, DIN 5264

■ Surface: Satin chrome finish. Material: Chrome-vanadium steel.

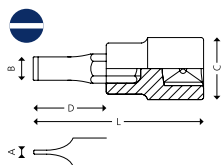

ITEM NO.	5704196+	A X B MM	C MM	D MM	L MM	G	U
5112-3012	003306	1,2 x 8	23,9	24	62	53	10
5112-3016	003313	1,6 x 10	23,9	24	62	87	10
5112-3020	003320	2 x 12	23,9	24	62	98	10

### 5112 PH 1/2" SOCKET DRIVERS FOR PHILLIPS® HEAD SCREWS

ISO 8764

■ Surface: Satin chrome finish. Material: Chrome-vanadium steel.

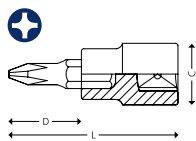

ITEM NO.	5704196+	PH	C MM	D MM	L MM	G	U
5112-3103	003351	3	23,9	24	62	89	10
5112-3104	010847	4	23,9	24	62	89	10

### 5112 PZ 1/2" SOCKET DRIVERS FOR POZIDRIV® HEAD SCREWS

ISO 8764

■ Surface: Satin chrome finish. Material: Chrome-vanadium steel.

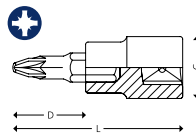

ITEM NO.	5704196+	PZ	C MM	D MM	L MM	G	U
5112-3203	003382	3	23,9	24	62	89	10
5112-3204	010854	4	23,9	24	62	89	10





## POLAR® SOCKETS AND ACCESSORIES



### 5112 H 1/2" SOCKET DRIVERS FOR HEX HEAD SCREWS

DIN 7422

- Surface: Satin chrome finish. Material: Chrome-vanadium steel.

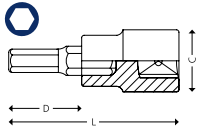

ITEM NO.	5704196+	SIZE MM	C MM	D MM	L MM	G	
5112-2005	003139	5	23,9	24	62	89	10
5112-2006	003146	6	23,9	24	62	89	10
5112-2007	003153	7	23,9	24	62	90	10
5112-2008	003160	8	23,9	24	62	91	10
5112-2009	019000	9	23,9	24	62	93	10
5112-2010	003184	10	23,9	24	62	95	10
5112-2012	003191	12	23,9	24	62	107	10
5112-2014	003207	14	23,9	24	62	121	10
5112-2017	003214	17	25,9	24	62	162	10
5112-2019	003221	19	25,9	24	62	170	10

### 5112HL 1/2" LONG SOCKET DRIVERS FOR HEX HEAD SCREWS

DIN 7422

- Surface: Satin chrome finish. Material: Chrome-vanadium steel.

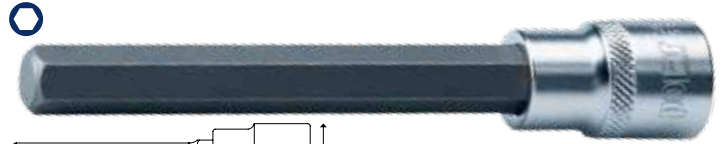
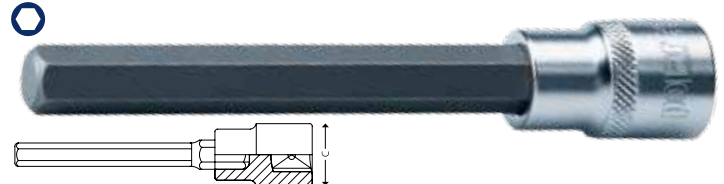

ITEM NO.	5704196+	SIZE MM	C MM	D MM	L MM	G	
5112-2105	010816	5	23,9	100	138	111	10
5112-2106	010823	6	23,9	100	138	113	10
5112-2107	010830	7	23,9	100	138	114	10
5112-2108	003238	8	23,9	100	138	114	10
5112-2109	019017	9	23,9	100	138	115	10
5112-2110	003252	10	23,9	100	138	143	10
5112-2112	003269	12	23,9	100	138	130	10
5112-2114	003276	14	23,9	100	138	224	10
5112-2117	003283	17	25,9	100	138	306	10
5112-2119	003290	19	25,9	100	138	320	10

### 5190 H 1/2" SOCKET DRIVER SET FOR HEX HEAD SCREWS

ITEM NO. 5190-1210

- Set in metal box with socket drivers for hex head screws from 5 to 19 mm.
- 10 tools.



3,1 KG  
 5704196 000688  
 1

CONTENT:

QTY.	DESCRIPTION	SIZE
10	Socket drivers for hex head screws	5112 1/2" H 5 - 6 - 7 - 8 - 9 - 10 - 12 - 14 - 17 - 19 mm



### 5191 HL 1/2" LONG SOCKET DRIVER SET FOR HEX HEAD SCREWS

ITEM NO. 5191-1210

- Set in metal box with long socket drivers for hex head screws from 5 to 19 mm.
- 10 tools.

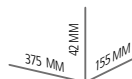

2,9 KG  
 5704196 000695  
 1

CONTENT:

QTY.	DESCRIPTION	SIZE
10	Long socket drivers for hex head screws	5112 1/2" HL 5 - 6 - 7 - 8 - 9 - 10 - 12 - 14 - 17 - 19 mm



## POLAR® SOCKETS AND ACCESSORIES

### 5112 TX 1/2" SOCKET DRIVERS FOR TORX® SCREWS

■ Surface: Satin chrome finish. Material: Chrome-vanadium steel.

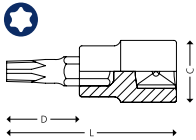

ITEM NO.	5704196+	TORX® NO.	★ MM	C MM	D MM	L MM	⚖️ G	📦
5112-1020	003047	T20	3,86	23,9	24	62	59	10
5112-1025	003054	T25	4,43	23,9	24	62	84	10
5112-1027	003061	T27	4,99	23,9	24	62	90	10
5112-1030	003078	T30	5,52	23,9	24	62	88	10
5112-1040	003085	T40	6,65	23,9	24	62	89	10
5112-1045	003092	T45	7,82	23,9	24	62	90	10
5112-1050	003108	T50	8,83	23,9	24	62	91	10
5112-1055	003115	T55	11,22	23,9	24	62	94	10
5112-1060	003122	T60	13,25	23,9	24	62	104	10

### 5112TXL 1/2" LONG SOCKET DRIVERS FOR TORX® SCREWS

■ Surface: Satin chrome finish. Material: Chrome-vanadium steel.

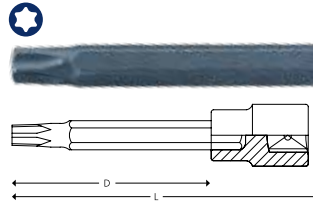

ITEM NO.	5704196+	TORX® NO.	★ MM	C MM	D MM	L MM	⚖️ G	📦
5112-1120	013107	T20	3,84	23,9	100	138	119	10
5112-1125	013114	T25	4,40	23,9	100	138	119	10
5112-1127	013121	T27	4,96	23,9	100	138	120	10
5112-1130	013138	T30	5,49	23,9	100	138	120	10
5112-1140	013145	T40	6,60	23,9	100	138	121	10
5112-1145	013152	T45	7,77	23,9	100	138	121	10
5112-1150	013169	T50	8,79	23,9	100	138	122	10
5112-1155	013176	T55	11,17	23,9	100	138	143	10
5112-1160	013183	T60	13,17	23,9	100	138	176	10

### 5190 TX 1/2" SOCKET DRIVER SET FOR TORX® SCREWS

ITEM NO. 5190-1209

- Set in metal box with Torx® socket drivers from TX20 to TX60.
- 9 tools.



CONTENT:

QTY.	DESCRIPTION	SIZE
9	Socket drivers for Torx® screws	5112 1/2" TX T20 - T25 - T27 - T30 - T40 - T45 - T50 - T55 - T60



⚖️ 1,5 KG

📦 5704196 000671

📦 1

9  
TOOLS

### 5191 TXL 1/2" LONG SOCKET DRIVER SET FOR TORX® SCREWS

ITEM NO. 5191-1209

- Set in metal box with long Torx® socket drivers from TX20 to TX60.
- 9 tools.



CONTENT:

QTY.	DESCRIPTION	SIZE
9	Long socket drivers for Torx® screws	5112 1/2" TXL T20 - T25 - T27 - T30 - T40 - T45 - T50 - T55 - T60

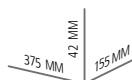

⚖️ 2,3 KG

📦 5704196 013190

📦 1

9  
TOOLS





# POLAR® SOCKETS AND ACCESSORIES



## 4712 1/2" SCREWDRIVER BIT SOCKET

ISO 1173-1174, DIN 3126.

- For use with 5/16" screwdriver bits.
- Surface: Satin chrome finish. Material: Chrome-vanadium steel.

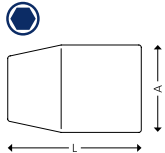

ITEM NO.	5704196+	5/16"	1/2"	A MM	L MM	G	10
4712-5012	010908			22	38,5	55	10

## 5712 A 1/2" ADAPTOR FROM 1/2" TO 3/8"

ISO 3316, DIN 3123

- Surface: Satin chrome finish. Material: Chrome-vanadium steel.

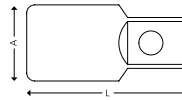

ITEM NO.	5704196+	1/2"	3/8"	A MM	L MM	G	10
5712-1238	003467			22	36	67	10

## 5212 EX 1/2" EXTENSIONS

ISO 3316, DIN 3123.

- With ext. 22 mm Hexagon.
- Surface: Satin chrome finish. Material: Chrome-vanadium steel.

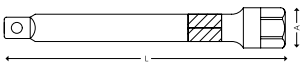

ITEM NO.	5704196+	L MM	A MM	G	10
5212-0075	003399	75	23	160	10
5212-0125	003405	125	23	247	10
5212-0250	003412	250	23	450	10

## 5612 A 1/2" ADAPTOR FROM 1/2" TO 3/4"

ISO 3316, DIN 3123

- Surface: Satin chrome finish. Material: Chrome-vanadium steel.

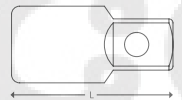

ITEM NO.	5704196+	1/2"	3/4"	A MM	L MM	G	10
5612-1234	003474			25	50	140	10

## 5212 EXW 1/2" WOBBLE EXTENSIONS

- Can be used for both wobble and rigid functionality.
- The wobble function provides 15° of additional accessibility.
- With ext. 22 mm Hexagon.
- Surface: Satin chrome finish. Material: Chrome-vanadium steel.

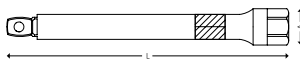

ITEM NO.	5704196+	L MM	A MM	G	10
5212-1075	011066	75	24	160	10
5212-1125	011073	125	24	247	10
5212-1150	011080	150	24	280	10
5212-1250	021959	250	24	420	10
5212-1500	011097	500	24	850	10

## 5412 TH 1/2" SLIDING T-HANDLE

ISO 3315, DIN 3122

- Surface: Satin chrome finish. Material: Chrome-vanadium steel.

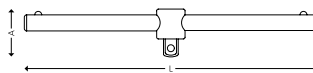

ITEM NO.	5704196+	L MM	A MM	G	10
5412-0012	003450	250	42	372	10





**POLAR®**

### 5812 U 1/2" UNIVERSAL JOINT

ISO 3316, DIN 3123

- Equipped with tension-spring.
- Joint stays at desired angle.
- Surface: Satin chrome finish. Material: Chrome-vanadium steel.

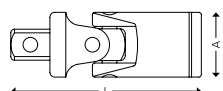

ITEM NO.	5704196+	L MM	A MM	G	10
5812-0012	003443	75	25	160	10

### 5912 FH 1/2" SWIVEL HANDLE

ISO 3315, DIN 3122.

- Heavy duty model.
- Surface: Satin chrome finish.  
Material: Handle in chrome-vanadium steel.  
Head in chrome-molybdenum steel.

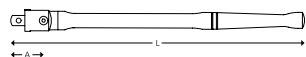

ITEM NO.	5704196+	L MM	A MM	G	6
5912-0410	003429	410	56	990	6
5912-0645	003436	645	56	1380	10

### 5312 1/2" REVERSIBLE RATCHET WITH LOCKING SYSTEM

ISO 3315, DIN 3122

- Model with 72 teeth and Quick Release.
- Compact head with a working angle of 5°.
- Surface: Satin chrome finish. Material: Chrome-vanadium steel.

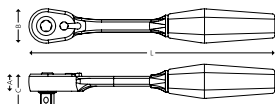

ITEM NO.	5704196+	A MM	B MM	C MM	L MM	G	1
5312-0072	003481	15,9	32,2	33,2	257	412	1





# POLAR® SOCKETS AND ACCESSORIES



## 3/4" 3/4" SOCKETS AND ACCESSORIES

### 5034 3/4" 6-POINT METRIC SOCKETS

ISO 2725-1, DIN 3124

- Surface: Chrome plated finish. Material: Chrome-vanadium steel.

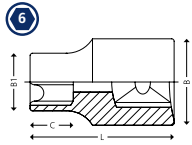

ITEM NO.	5704196+	SIZE MM	B MM	B1 MM	C MM	L MM	G	Icon
5034-0019	003498	19	33,0	29,2	14	50	170	5
5034-0021	003504	21	33,0	31,2	14	50	190	5
5034-0022	003511	22	36,0	32,2	14	50	220	5
5034-0024	003528	24	36,0	34,2	16	51	230	5
5034-0027	003535	27	36,0	38,0	22	52	240	5
5034-0030	003542	30	38,0	42,0	24	54	280	5
5034-0032	003559	32	38,0	44,0	26	56	310	5
5034-0036	003566	36	42,0	50,0	28	58	430	5
5034-0038	003573	38	45,0	52,0	28	60	500	5
5034-0041	003580	41	45,0	56,0	30	64	570	5
5034-0046	003597	46	48,0	62,0	34	68	700	5
5034-0050	003603	50	48,0	68,0	36	72	850	5

### 5434 TH 3/4" SLIDING T-HANDLE

ISO 3315, DIN 3122

- Surface: Chrome plated finish. Material: Chrome-vanadium steel.



ITEM NO.	5704196+	L MM	A MM	G	Icon
5434-0450	003641	450	60	1380	1

### 5934 FH 3/4" SWIVEL HANDLE - 500 MM

ISO 3315, DIN 3122

- Surface: Chrome plated finish. Material: Chrome-vanadium steel.



ITEM NO.	5704196+	L MM	A MM	G	Icon
5934-0475	003658	500	57	1850	1

### 5234 EX 3/4" EXTENSIONS

ISO 3316, DIN 3123

- Surface: Chrome plated finish. Material: Chrome-vanadium steel.

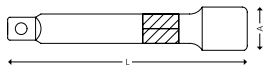
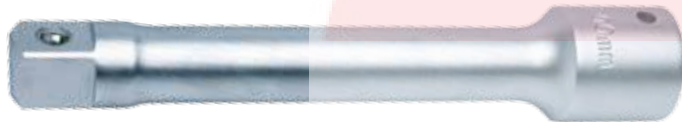

ITEM NO.	5704196+	L MM	A MM	G	Icon
5234-0100	003610	100	36	410	1
5234-0200	003627	200	36	710	1

### 5934 FH 3/4" SWIVEL HANDLE - 1000 MM

ISO 3315, DIN 3122

- Surface: Chrome plated finish. Material: Chrome-vanadium steel.



ITEM NO.	5704196+	L MM	A MM	G	Icon
5934-1000	017129	1000	85	3650	1

### 5734 A 3/4" ADAPTOR FROM 3/4" TO 1/2"

ISO 3316, DIN 3123

- Surface: Chrome plated finish. Material: Chrome-vanadium steel.

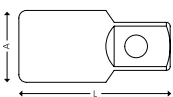

ITEM NO.	5704196+	Icon	Icon	A MM	L MM	G	Icon
5734-3412	003634	3/4"	1/2"	34	54	170	5

### 5334 3/4" REVERSIBLE RATCHET

ISO 3315, DIN 3122

- Model with 40 teeth. Working angle of 9°.
- Surface: Chrome plated finish. Material: Chrome-vanadium steel.

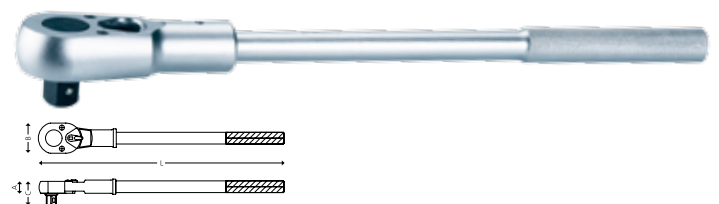

ITEM NO.	5704196+	A MM	B MM	C MM	L MM	G	Icon
5334-0040	003655	32,4	65,5	58	500	2850	1



## POLAR® AIR TOOLS

# AIR TOOLS

*POLAR® Air tools are designed to work comfortably and feature heavy duty components to resist the everyday use.*

*POLAR® offers a very wide range of air tools, which combines power and durability.*

- Compact design – allows easy access to tight spaces
- Twin hammer impact mechanisms – performing maximum power
- Reduced vibration – shock absorption reduce the stress from vibration
- Balanced design – for better user control
- Low noise – for a comfortable working environment
- Comfort grip – ergonomic grip, to take the strain out of repetitive use.

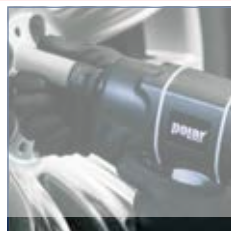





## POLAR® AIR TOOLS

# IMPACT WRENCHES

POLAR® Composite impact wrenches are all manufactured with the durable and hard hitting twin hammer mechanism. Choose among nine different models.



3 speed regulator

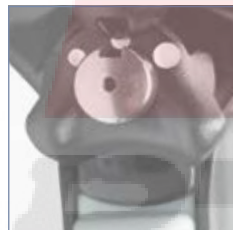

Forward/Reverse and speed level by one-hand switching



Handle exhaust

### 6100 C 1/2" MINI IMPACT WRENCH

ITEM NO. 6100-0012

▲ 1,3 KG L 122 MM

▮ 5704196 019758

📦 1

- Composite motor housing.
- Lightweight.
- Handle exhaust. Twin hammer.
- One hand push button forward / reverse.
- Compact design for narrow space.
- Steel ring to retain the sockets.

**TECHNICAL DATA:**

Working torque: 50 - 550 Nm  
Max. torque: 610 Nm  
Speed: 9.000 RPM  
Noise level: 89 db(A)  
Air inlet: 1/4"  
Hose size: 3/8" (10 mm)  
Air consumption: 120 L/Min



### 6100 C1 1/2" IMPACT WRENCH

ITEM NO. 6100-1012

▲ 1,9 KG L 165 MM

▮ 5704196 019765

📦 1

- Composite motor housing.
- Lightweight.
- Handle exhaust. Twin hammer.
- One hand push button forward / reverse.
- Steel ring to retain the sockets.

**TECHNICAL DATA:**

Working torque: 70 - 880 Nm  
Max. torque: 1.220 Nm  
Speed: 6.500 RPM  
Noise level: 89 db(A)  
Air inlet: 1/4"  
Hose size: 3/8" (10 mm)  
Air consumption: 135 L/Min





# POLAR® AIR TOOLS



## 6100 B 3/8" IMPACT WRENCH

ITEM NO. 6100-0038

▲ 1,2 KG L 153 MM

▮ 5704196 019987

📦 1

- Composite motor housing.
- Lightweight.
- Handle exhaust.
- Twin hammer clutch mechanism.
- One hand push button forward/reverse.
- Steel ring to retain the sockets.

### TECHNICAL DATA:

Working torque: 34 - 338 Nm  
 Max. torque: 410 Nm  
 Speed: 11.000 RPM  
 Noise level: 83 db(A)  
 Air inlet: 1/4"  
 Hose size: 3/8" (10 mm)  
 Air consumption: 113 L/Min



## 6100 C2 1/2" IMPACT WRENCH

ITEM NO. 6100-2012

▲ 2,1 KG L 186 MM

▮ 5704196 019772

📦 1

- Composite motor housing.
- Silenced handle exhaust.
- Twin hammer.
- Steel ring to retain the sockets.

### TECHNICAL DATA:

Working torque: 68 - 746 Nm  
 Max. torque: 813 Nm  
 Speed: 9.000 RPM  
 Noise level: 84 db(A)  
 Air inlet: 1/4"  
 Hose size: 3/8" (10 mm)  
 Air consumption: 120 L/Min





## POLAR® AIR TOOLS

### 6100 D 3/4" IMPACT WRENCH

ITEM NO. 6100-0034

- 3,3 KG    L 215 MM
- 5704196 019789
- 1



- Composite motor housing.
- Lightweight.
- Handle exhaust.
- Twin hammer clutch mechanism.
- One hand push button forward/reverse.
- Steel ring to retain the sockets..

**TECHNICAL DATA:**

Working torque: 271 - 1627 Nm  
 Max. torque: 1.898 Nm  
 Speed: 5.500 RPM  
 Noise level: 90 db(A)  
 Air inlet: 3/8"  
 Hose size: 1/2" (13 mm)  
 Air consumption: 198 L/Min

### 6100 E2 1" IMPACT WRENCH

ITEM NO. 6100-2010

- 3,4 KG    L 223 MM
- 5704196 019994
- 1



- Composite motor housing.
- Lightweight.
- Handle exhaust.
- Twin hammer clutch mechanism.
- One hand push button forward/reverse.
- Steel ring to retain the sockets..

**TECHNICAL DATA:**

Working torque: 271-1627 Nm  
 Max. torque: 1.898 Nm  
 Speed: 5.500 RPM  
 Noise level: 90 db(A)  
 Air inlet: 3/8"  
 Hose size: 1/2" (13 mm)  
 Air consumption: 198 L/Min

### 6100 E 1" IMPACT WRENCH

ITEM NO. 6100-0010    5704196 019796    L 412 MM    10 KG    1



- Side handle for better control.
- Handle with inside trigger.
- Steel ring to retain the sockets.
- Twin hammer clutch mechanism.

**TECHNICAL DATA:**

Working torque: 542 - 2441 Nm  
 Max. torque: 3.119 Nm  
 Speed: 5.000 RPM  
 Noise level: 109 db(A)  
 Air inlet: 1/2"  
 Hose size: 1/2" (13 mm)  
 Air consumption: 282 L/Min



Forward/Reverse  
and speed level

### 6100 E1 1" IMPACT WRENCH WITH 8" LONG ANVIL

ITEM NO. 6100-1010    5704196 019802    L 520 MM    11 KG    1



- Side handle for better control.
- Handle with inside trigger.
- Steel ring to retain the sockets.
- Twin hammer clutch mechanism.

**TECHNICAL DATA:**

Working torque: 542 - 2441 Nm  
 Max. torque: 3.119 Nm  
 Speed: 5.000 RPM  
 Noise level: 109 db(A)  
 Air inlet: 1/2"  
 Hose size: 1/2" (13 mm)  
 Air consumption: 282 L/Min



Forward/Reverse  
and speed level



## POLAR® AIR TOOLS



# RATCHETS

All POLAR® Ratchets are manufactured with needle bearings, providing a smooth running tool.



### 6105 A 1/4" STUBBY RATCHET

ITEM NO. 6105-0014    5704196 019819    L 133 MM    0,4 KG    1



- Composite motor housing.
- Short and compact size.
- Rear exhaust.

**TECHNICAL DATA:**

Max. torque: 40,7 Nm	Hose size: 3/8" (10 mm)
Speed: 350 RPM	Air consumption: 113 L/Min
Noise level: 85 db(A)	
Air inlet: 1/4"	

### 6105 B 3/8" STUBBY RATCHET WITH WOBBLE-SQUARE

ITEM NO. 6105-1038    5704196 019826    L 133 MM    0,5 KG    1



- Composite motor housing.
- Short and compact size. Rear exhaust.
- Wobble function provides 15° of additional accessibility.

**TECHNICAL DATA:**

Max. torque: 40,7 Nm	Hose size: 3/8" (10 mm)
Speed: 350 RPM	Air consumption: 113 L/Min
Noise level: 85 db(A)	
Air inlet: 1/4"	

Wobble-square

### 6105 B1 3/8" RATCHET

ITEM NO. 6105-0038    5704196 019833    L 256 MM    1,2 KG    1



- Cushioned grip. Strong ratchet head.
- Rotating air inlet. Rotating rear exhaust with silencer.

**TECHNICAL DATA:**

Working torque: 14 - 68 Nm	Air inlet: 1/4"
Max. torque: 68 Nm	Hose size: 3/8" (10 mm)
Speed: 150 RPM	Air consumption: 113 L/Min
Noise level: 79 db(A)	

### 6105C 1/2" RATCHET

ITEM NO. 6105-0012    5704196 019840    L 256 MM    1,2 KG    1



- Cushioned grip. Strong ratchet head.
- Rotating air inlet. Rotating rear exhaust with silencer.

**TECHNICAL DATA:**

Working torque: 14 - 68 Nm	Air inlet: 1/4"
Max. torque: 68 Nm	Hose size: 3/8" (10 mm)
Speed: 150 RPM	Air consumption: 113 L/Min
Noise level: 79 db(A)	



## POLAR® AIR TOOLS

# GRINDERS

*POLAR® Mini grinders with ergonomic handles are contoured to fit comfortably in the hand, as well as absorb vibration.*



### 6110 A MINI GRINDER

ITEM NO. 6110-0000 5704196 019659 L 163 MM 0,4 KG 1



- Comfort grip.
- Rotating rear regulator. Safety throttle lever.
- Rear exhaust with silencer. Rotating air inlet.

**TECHNICAL DATA:**

Speed: 25.000 RPM    Hose size: 3/8" (10 mm)  
Collet size: 1/4" (6 mm)    Air consumption: 113 L/Min  
Noise level: 77 db(A)  
Air inlet: 1/4"

### 6110 C MINI GRINDER, 115° ANGLE HEAD

ITEM NO. 6110-0115 5704196 019673 L 200 MM 0,5 KG 1



- Comfort grip. Rotating rear regulator. Safety throttle lever.
- Rear exhaust with silencer. Rotating air inlet.

**TECHNICAL DATA:**

Speed: 20.000 RPM    Hose size: 3/8" (10 mm)  
Collet size: 1/4" (6 mm)    Air consumption: 113 L/Min  
Noise level: 77 db(A)  
Air inlet: 1/4"

### 6110 B MINI GRINDER, 90° ANGLE HEAD

ITEM NO. 6110-0090 5704196 019666 L 166 MM 0,5 KG 1



- Comfort grip. Rotating rear regulator. Safety throttle lever.
- Rear exhaust with silencer. Rotating air inlet.

**TECHNICAL DATA:**

Speed: 20.000 RPM    Hose size: 3/8" (10 mm)  
Collet size: 1/4" (6 mm)    Air consumption: 113 L/Min  
Noise level: 77 db(A)  
Air inlet: 1/4"

### 6110 D MINI GRINDER, 3" CUT-OFF TOOL

ITEM NO. 6110-1075 5704196 019680 L 203 MM 0,8 KG 1



- Comfort grip.
- Rotating rear regulator. Safety throttle lever.
- Rear exhaust with silencer. Rotating air inlet.

**TECHNICAL DATA:**

Speed: 20.000 RPM    Hose size: 3/8" (10 mm)  
Disc size: 3" (75 mm)    Air consumption: 113 L/Min  
Noise level: 79 db(A)  
Air inlet: 1/4"



### 6120 A 5" ANGLE GRINDER

ITEM NO. 6120-0125 5704196 019710 L 238 MM 2 KG 1



- Composite motor housing.
- 9 position adjustable swivel guard. Side handle.
- Spindle lock allows quick and easy disc change.
- Powerful 0,75 HP motor. Low noise level.

**TECHNICAL DATA:**

Speed:	10.000 RPM	Air inlet:	1/4"
Disc size:	5" (125 mm)	Hose size:	3/8" (10 mm)
Spindle thread:	M14 x 2.0	Air consumption:	113 L/Min
Noise level:	83 db(A)		
Power:	0,7 HP (0,52 Kw)		

### 6120 B 7" ANGLE GRINDER

ITEM NO. 6120-0175 5704196 019727 L 355 MM 3,3 KG 1



- Spindle lock allows quick and easy disc change.
- Push button lock off lever. Rubber comfort grip.
- Front exhaust.

**TECHNICAL DATA:**

Speed:	8.500 RPM	Air inlet:	3/8"
Disc size:	7" (175 mm)	Hose size:	3/8" (10 mm)
Spindle thread:	5/8" - 11	Air consumption:	113 L/Min
Noise level:	89 db(A)		
Power:	1,3 HP (0,97 Kw)		

### 6125 LONG ANGLE GRINDER, 4" CUT-OFF TOOL

ITEM NO. 6125-0100 5704196 019734 L 377 MM 1,7 KG 1



- Spindle lock allows quick and easy disc change. Rear exhaust.
- Built-in cushion grip. Push to adjust guard.
- 11 position adjustable swivel guard.

**TECHNICAL DATA:**

Speed:	14.000 RPM	Air inlet:	1/4"
Disc size:	4" (100 mm)	Hose size:	3/8" (10 mm)
Disc hole:	3/8" (10)	Air consumption:	113 L/Min
Noise level:	87 db(A)		
Power:	1,0 HP (0,75 Kw)		

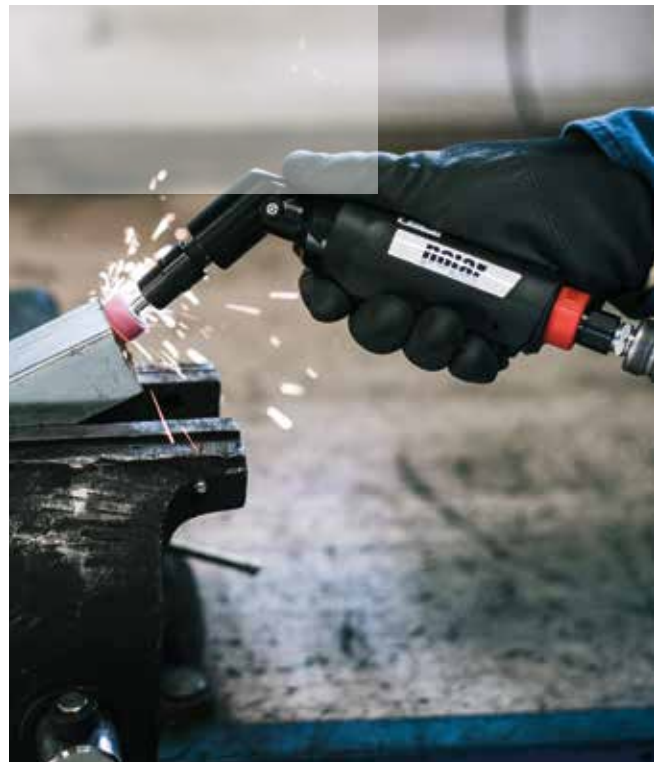



## POLAR® AIR TOOLS



SANDERS, POLISHER & HAMMER

### 6113 5" REVERSIBLE HIGH SPEED SANDER

ITEM NO. 6113-0125

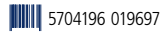

5704196 019697

L 142 MM

1 KG



- Composite motor housing.
- Reversing bar on both sides.
- Handle exhaust.

**TECHNICAL DATA:**

Speed: 16.000 RPM  
Pad size: 3" - 4" - 5"  
Noise level: 83 db(A)  
Power: 0,6 HP (0,45 Kw)  
Air inlet: 3/8"  
Hose size: 3/8" (10 mm)  
Air consumption: 113 L/Min

### 6115 5" RANDOM ORBITAL SANDER

ITEM NO. 6115-0150

0,7 KG

L 196 MM

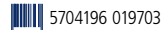

5704196 019703



- Composite motor housing.
- Exhaust to central-vacuum system.
- Low vibration.
- Lightweight.
- Low noise level.

**TECHNICAL DATA:**

Speed:	12.000 RPM	Power:	0,6 HP (0,45 Kw)
Orbit diameter:	5 mm	Air inlet:	1/4"
Pad size:	5" (125 mm)	Hose size:	3/8" (10 mm)
Spindle thread:	5/16"	Air consumption:	57 L/Min
Noise level:	84 db(A)		
Vibration level:	1,2 m/s <sup>2</sup>		

### 6127 7" ANGLE POLISHER

ITEM NO. 6127-0175

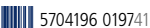

5704196 019741

L 307 MM

1,9 KG



- Rubber comfort grip. Safety lever.
- Spindle lock button. Rear exhaust.

**TECHNICAL DATA:**

Speed:	2.500 RPM	Hose size:	3/8" (10 mm)
Pad size:	7" (175 mm)	Air consumption:	91 L/Min
Spindle thread:	5/8" - 11		
Air inlet:	1/4"		

### 6135 HAMMER WITH HEX-SHANK

ITEM NO. 6135-0001



5704196 019871

L 133 MM

1,4 KG



**TECHNICAL DATA:**

Blows per minute:	5.000 BPM
Stroke length:	1 5/8" (41 mm)
Air inlet:	1/4"
Hose size:	3/8" (10 mm)
Air consumption:	113 L/Min



## POLAR® AIR TOOLS



### DRILLS & NEEDLE SCALERS

#### 6130 A DRILL, 10 MM

ITEM NO. 6130-0010  5704196 019857 L 185 MM  1,1 KG  1





- Composite motor housing.
- Two speed trigger.
- Reversing bar on both sides.
- Keyless chuck.

**TECHNICAL DATA:**

Speed: 1.800 RPM  
 Chuck size: 3/8" (10 mm)  
 Noise level: 83 db(A)  
 Power: 0,5 HP (0,37 Kw)  
 Air inlet: 1/4"  
 Hose size: 3/8" (10 mm)  
 Air consumption: 113 L/Min

#### 6130 B DRILL, 13 MM

ITEM NO. 6130-0013  5704196 019864 L 218 MM  1,3 KG  1





- Composite motor housing.
- Two speed trigger.
- Reversing bar on both sides.
- Keyless chuck.

**TECHNICAL DATA:**

Speed: 800 RPM  
 Chuck size: 1/2" (13 mm)  
 Noise level: 83 db(A)  
 Power: 0,5 HP (0,37 Kw)  
 Air inlet: 1/4"  
 Hose size: 3/8" (10 mm)  
 Air consumption: 113 L/Min

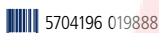
#### 6137 A NEEDLE SCALER - STRAIGHT

ITEM NO. 6137-0001  5704196 019888 L 376 MM  2,6 KG  1



**TECHNICAL DATA:**

Blows per minute: 3.000 BPM  
 Needle diameter: 3 mm  
 Qty. needles: 19 pcs.  
 Air inlet: 1/4"  
 Hose size: 3/8" (10 mm)  
 Air consumption: 113 L/Min

#### 6137 B NEEDLE SCALER - PISTOL

ITEM NO. 6137-0002  5704196 019895 L 315 MM  2,6 KG  1



**TECHNICAL DATA:**

Blows per minute: 3.000 BPM  
 Needle diameter: 3 mm  
 Qty. needles: 19 pcs.  
 Air inlet: 1/4"  
 Hose size: 3/8" (10 mm)  
 Air consumption: 113 L/Min





## POLAR® AIR TOOLS

### 1/2" IMPACT SOCKETS AND ACCESSORIES

#### 6012 1/2" 6-POINT METRIC IMPACT SOCKETS

■ Surface: Phosphatised finish. Material: Chrome-molybdenum steel.

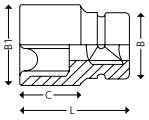

ITEM NO.	5704196+	SIZE MM	B MM	B1 MM	C MM	L MM	G	
6012-0010	016054	10	25	17,5	12	39	70	1
6012-0011	016061	11	25	18,5	12	39	71	1
6012-0012	016078	12	25	20,0	12	39	72	1
6012-0013	016085	13	25	21,0	12	39	74	1
6012-0014	016092	14	25	22,5	12	39	79	1
6012-0015	016108	15	30	25,0	12	39	119	1
6012-0016	016115	16	30	26,0	12	39	121	1
6012-0017	016122	17	30	26,0	13	39	122	1
6012-0018	016139	18	30	27,5	13	39	123	1
6012-0019	016146	19	30	28,0	13	39	125	1
6012-0021	016153	21	30	30,0	13	39	127	1
6012-0022	016160	22	30	32,0	13	39	131	1
6012-0024	016177	24	30	34,0	20	39	175	1
6012-0027	016184	27	30	38,0	24	43	225	1
6012-0030	016191	30	30	42,0	24	48	253	1
6012-0032	016207	32	30	44,0	26	48	273	1

#### 6012 L 1/2" 6-POINT LONG METRIC IMPACT SOCKETS

■ Surface: Phosphatised finish. Material: Chrome-molybdenum steel.

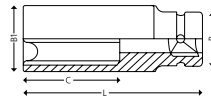

ITEM NO.	5704196+	SIZE MM	B MM	B1 MM	C MM	L MM	G	
6012-4010	016214	10	24	17,5	14	78	154	1
6012-4011	016221	11	24	18,5	14	78	163	1
6012-4012	016238	12	24	20,0	14	78	169	1
6012-4013	016245	13	24	21,0	14	78	185	1
6012-4014	016252	14	24	22,0	17	78	201	1
6012-4015	016269	15	24	24,0	17	78	213	1
6012-4016	016276	16	24	24,0	17	78	224	1
6012-4017	016283	17	26	26,0	17	78	252	1
6012-4018	016290	18	28	28,0	17	78	283	1
6012-4019	016306	19	28	28,0	19	78	268	1
6012-4021	016313	21	30	30,0	24	78	310	1
6012-4022	016320	22	30	32,0	24	78	302	1
6012-4024	016337	24	30	34,0	24	78	309	1
6012-4027	016344	27	30	38,0	24	78	325	1
6012-4030	016351	30	30	42,0	24	78	352	1
6012-4032	016368	32	30	44,0	24	78	317	1

#### 6090 1/2" METRIC SOCKET WRENCH SET

ITEM NO. 6090-1222

- Set in watertight plastic case with 6-point impact sockets from 10 to 32 mm and accessories.
- 22 tools.

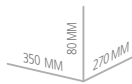

3,5 KG

5704196 016474

1



CONTENT:

QTY.	DESCRIPTION	SIZE
15	6-point sockets	6012 1/2" 10 - 11 - 12 - 13 - 14 - 15 - 16 - 17 - 19 - 21 - 22 - 24 - 27 - 30 - 32 mm
1	Extension	6212 1/2" EX 125 mm
1	Adaptor	6638 1/2" A
2	Safety set	6012 1/2" SR 8 - 14 mm / 15 - 32 mm





**POLAR®**  
AIR TOOLS



**6090 L 1/2" METRIC SOCKET WRENCH SET**

ITEM NO. 6090-1220

- Set in watertight plastic case with 6-point long impact sockets from 10 to 32 mm and accessories.
- 20 tools.

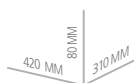

4,6 KG

5704196 016481

1

**20  
TOOLS**



**CONTENT:**

QTY.	DESCRIPTION	SIZE
15	Long 6-point sockets	6012 1/2" L 10 - 11 - 12 - 13 - 14 - 15 - 16 - 17 - 19 - 21 - 22 - 24 - 27 - 30 - 32 mm
1	Extension	6212 1/2" EX 125 mm
2	Safety set	6012 1/2" SR 8 - 14 mm / 15 - 32 mm



## POLAR® AIR TOOLS

### 6090 LT 1/2" METRIC SOCKET WRENCH SET

ITEM NO. 6090-1204

- Set in metal box with 6-point long impact sockets with thin walls for wheel nuts.
- 6 tools.

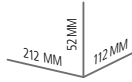

1,5 KG

5704196 016467

1



**CONTENT:**

QTY.	DESCRIPTION	SIZE
4	Long thinwalled 6-point sockets	6012 1/2" LT 17 - 19 - 21 - 22 mm
1	Safety set	6012 1/2" SR 15 - 32 mm

### 6012 LT 1/2" 6-POINT LONG METRIC IMPACT SOCKETS

- Model with thin walls for wheel nuts.
- Surface: Phosphatised finish. Material: Chrome-molybdenum steel.

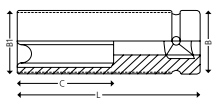

ITEM NO.	5704196+	SIZE MM	B MM	B1 MM	C MM	L MM	G G	1
6012-4117	016375	17	30	24,0	24	85	240	1
6012-4119	016382	19	30	26,0	24	85	259	1
6012-4121	016399	21	30	28,0	24	85	270	1
6012-4122	016405	22	30	29,5	24	85	296	1

### 6734 A 3/4" ADAPTOR FROM 3/4" TO 1/2"

- Surface: Phosphatised finish. Material: Chrome-molybdenum steel.

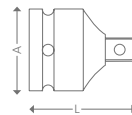

ITEM NO.	5704196+	3/4"	1/2"	A MM	L MM	G G	1
6734-3412	016412	3/4"	1/2"	44	56	305	1

### 6212 EX 1/2" EXTENSIONS

- Surface: Phosphatised finish. Material: Chrome-molybdenum steel.



ITEM NO.	5704196+	L MM	A MM	G G	1
6212-0075	016443	75	24	138	1
6212-0125	016450	125	24	215	1

### 6638 A 3/8" ADAPTOR FROM 3/8" TO 1/2"

- Surface: Phosphatised finish. Material: Chrome-molybdenum steel.

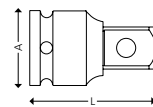

ITEM NO.	5704196+	3/8"	1/2"	A MM	L MM	G G	1
6638-3812	016429	3/8"	1/2"	22	38	64	1





## POLAR® AIR TOOLS



### 6812 U 1/2" UNIVERSAL JOINT

- Surface: Phosphatised finish. Material: Chrome-molybdenum steel.

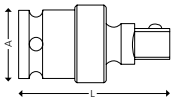

ITEM NO.	5704196+	L MM	A MM	G	1
6812-0012	016436	65	28	205	1

### 6012 SR 1/2" SAFETY SET

- Includes safety ring and pin.



ITEM NO.	5704196+	SIZE	G	1
6012-9301	016498	6012 1/2" 8 - 14 mm	3	1
6012-9302	016504	6012 1/2" 15 - 32 mm	4	1

### 6910 A AIRTOOL OIL - 100 ML

- Reliable protection.
- Mist lubrication applications.
- Specifications and approvals:  
ISO 6743-11, Types PAC and PBC.



ITEM NO.	5704196+	G	1
6910-0010	024967	98	1

### 6910 1/4" MINI OILER

- Provides automatic lubrication of pneumatic air tools

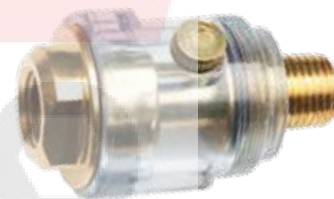

ITEM NO.	5704196+	G	1
6910-0014	021591	77	1

### 6100 SERVICE KITS

- Find all spareparts on polartools.com.



### 6910 A AIRTOOL OIL - 1000 ML

- Reliable protection.
- Mist lubrication applications.
- Specifications and approvals:  
ISO 6743-11, Types PAC and PBC.



ITEM NO.	5704196+	G	1
6910-0100	021997	888	1

### 6100 REBUILD KITS

- Find all spareparts on polartools.com.

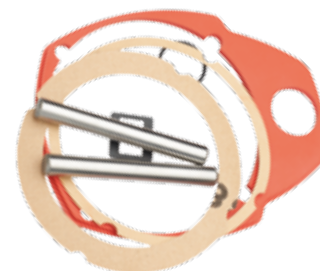



## POLAR® STRIKING TOOLS

# HAMMERS

POLAR® offers a wide range of striking tools made of carbon steel and high grade chrome-molybdenum steel. Precision heat treatment and the carefully machined parts are made for optimum performance and to enhance your safety.

- Ball pein hammers
- Claw hammers
- Mechanics hammers
- Sledge hammers
- Dead-blow hammers
- Engineers sledge hammers
- Pin punches
- Taper punches
- Center punches
- Cape chisels
- Flat chisels
- Wood chisels



Precision heat treatment



"One piece" construction delivers increased strength

Ergonomic comfort handle



## POLAR® STRIKING TOOLS



### 8010 BALL PEIN HAMMERS

ISO 15601

- Model with round flat head and ball shaped pein. Hickory handle.
- Surface: Polished and enamelled. Material: Forged carbon steel head.



ITEM NO.	5704196+	GRAMS	OZ	A MM	B MM	C MM	L MM	G G	
8010-0230	009094	230	8	27	24	82	295	355	6
8010-0340	009100	340	12	31	25	94	297	495	6
8010-0450	009117	450	16	33	30	104	344	645	6
8010-0680	009124	680	24	36	31	121	397	940	6
8010-0900	009131	900	32	40	34	127	397	1280	6

### 8020 F CLAW HAMMER

- Model with round flat head and curved claw.
- Fiberglass shaft with rubber handle.
- Surface: Polished and enamelled. Material: Forged carbon steel head.



ITEM NO.	5704196+	GRAMS	OZ	A MM	B MM	L MM	G G	
8020-2450	009087	450	16	30	127	337	760	6

### 8020 T CLAW HAMMER

- Round flat head and curved claw. Tubular steel shaft with rubber handle.
- Surface: Polished and enamelled. Material: Forged carbon steel head.

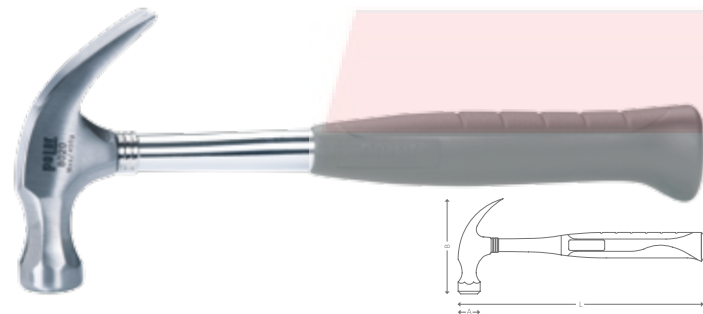

ITEM NO.	5704196+	GRAMS	OZ	A MM	B MM	L MM	G G	
8020-0450	009063	450	16	30	127	325	765	6

### 8030 MECHANICS HAMMERS

ISO 15601, DIN 1041

- Model with Hickory handle and steel protection.
- Surface: Polished and enamelled. Material: Forged carbon steel head.



ITEM NO.	5704196+	A MM	B MM	L MM	G G	
8030-0100	009162	15	82	260	173	10
8030-0200	012964	19	95	280	271	10
8030-0300	009148	23	105	300	448	10
8030-0500	009155	27	118	320	652	10
8030-0800	012971	33	130	350	1054	10
8030-1000	012988	34	134	360	1228	4
8030-1500	012995	43	147	380	1847	4
8030-2000	013008	45	155	400	2112	1

### 8020 S CLAW HAMMER

- Model with round flat head and curved claw.
- "One Piece" steel shaft with rubber handle.
- Surface: Polished and enamelled. Material: Forged carbon steel head and shaft.



ITEM NO.	5704196+	GRAMS	OZ	A MM	B MM	L MM	G G	
8020-1450	009070	450	16	30	127	330	760	6





**POLAR®**

## 8040 SLEDGE HAMMERS

ISO 15601, DIN 6475

- Model with Hickory handle and steel protection.
- Surface: Polished and enamelled. Material: Forged carbon steel head.



ITEM NO.	5704196+	A MM	B MM	L MM	G G	6
8040-1000	009001	40	95	260	1233	6
8040-1250	009018	43	100	260	1375	6
8040-1500	009025	45	110	275	1642	4
8040-2000	009032	50	120	300	2327	4

## 8060 DEAD-BLOW HAMMERS

- Model with head and shaft covered by urethane.
- Dead-blow hammer filled with steelshots. PVC handgrip.



ITEM NO.	5704196+	A MM	B MM	L MM	G G	6
8060-0030	009179	35	90	280	400	12
8060-0040	009186	45	90	300	580	6
8060-0050	009193	55	110	355	1050	6

## 8070 ENGINEERS SLEDGE HAMMERS

- Surface: Polished and enamelled. Material: Forged carbon steel head.



ITEM NO.	5704196+	A MM	B MM	L MM	G G	6
8070-3000	013015	55	160	600	3500	4
8070-4000	013022	65	170	700	4500	4
8070-5000	013039	70	180	800	5700	2





## POLAR® STRIKING TOOLS



# PUNCHES & CHISELS

POLAR® Chisels are manufactured of high grade chrome-molybdenum steel and differentially heat treated for optimum performance. The hardness of the striking head is reduced to help toughness.

Differentially heat treated  
for optimum performance

Chrome-molybdenum steel

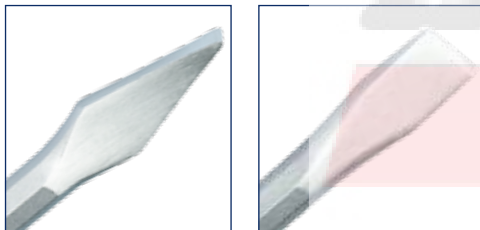



### PUNCHES AND CHISELS

#### 8200 PIN PUNCHES

DIN 6450

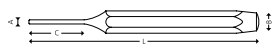
- Surface: Chrome plated finish. Material: Chrome-molybdenum steel.



ITEM NO.	5704196+	A MM	B MM	C MM	L MM	G G	
8200-0002	009209	2	8	23	115	34	25
8200-0003	009216	3	8	32	125	35	25
8200-0004	009223	4	10	35	150	64	25
8200-0005	009230	5	10	43	165	72	25
8200-0006	009247	6	13	47	180	136	25
8200-0008	009254	8	13	50	180	146	25

#### 8290 PP/6 ASSORTMENT WITH 6 PIN PUNCHES

- Supplied in nylon bag.

6  
TOOLS



ITEM NO.	5704196+	QTY.	SIZE MM	G	
8290-0006	000886	6	2-3-4-5-6-8 mm	545	1
P8290-0006	017075	1	Empty pouch for 8290-0006	52	1



## POLAR® STRIKING TOOLS

### 8205 TAPER PUNCHES

DIN 6458

- Surface: Chrome plated finish. Material: Chrome-molybdenum steel.

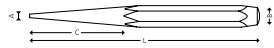

ITEM NO.	5704196+	A MM	B MM	C MM	L MM	G G	
8205-0002	009278	2	10	48	120	52	25
8205-0003	009285	3	10	48	120	53	25
8205-0004	009292	4	10	48	120	55	25
8205-0005	009308	5	10	48	120	58	25
8205-0006	009315	6	10	48	120	59	25

### 8215 CAPE CHISELS

DIN 6451

- Surface: Chrome plated finish. Material: Chrome-molybdenum steel.

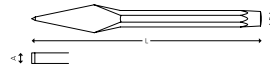

ITEM NO.	5704196+	A MM	B MM	L MM	G G	
8215-0005	009346	5	10	130	63	25
8215-0007	009353	7	13	165	147	25

### 8290 TP/5 ASSORTMENT WITH 5 TAPER PUNCHES

- Supplied in nylon bag.



ITEM NO.	5704196+	QTY.	SIZE MM	G G	
8290-0005	000893	5	2 - 3 - 4 - 5 - 6 mm	315	1
P8290-0005	017068	1	Empty pouch for 8290-0005	47	1

### 8220 FLAT CHISELS

DIN 6453

- Surface: Chrome plated finish. Material: Chrome-molybdenum steel.



ITEM NO.	5704196+	A MM	B MM	L MM	G G	
8220-0012	009360	12	10	130	68	25
8220-0018	009384	18	13	165	158	10

### 8290 S/17 ASSORTMENT WITH 17 TOOLS

- Supplied with metal holder.
- Content:
  - 2 Center punches: 1 - 2 mm
  - 5 Taper punches: 2 - 3 - 4 - 5 - 6 mm
  - 6 Pin punches: 2 - 3 - 4 - 5 - 6 - 8 mm
  - 2 Flat chisels: 12 - 18 mm
  - 2 Cape chisels: 5 - 7 mm



ITEM NO.	5704196+	G G	
8290-0017	000916	1,6	1

### 8210 CENTER PUNCHES

DIN 7250

- Surface: Chrome plated finish. Material: Chrome-molybdenum steel.

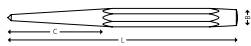

ITEM NO.	5704196+	A MM	B MM	C MM	L MM	G G	
8210-0001	009322	1	8	40	100	32	10
8210-0002	009339	2	10	50	120	54	10



## POLAR® STRIKING TOOLS



### 8290 S/5 ASSORTMENT WITH 5 TOOLS

- Supplied in nylon bag.
- Content:
  - 1 Taper punch: 3 x 120 mm
  - 1 Center punch: 2 x 120 mm
  - 1 Cape chisel: 5 x 130 mm
  - 1 Flat chisel: 12 x 130 mm
  - 1 Pin punch: 4 x 150 mm



5  
TOOLS

ITEM NO. 5704196+

8290-1005 000909

P8290-1005 017082 Empty pouch for 8290-1005

G 350 1  
53 1

### WOOD CHISELS

#### 8300 WOOD CHISEL

- Allround wood chisel with good durability.
- Precisioncut blade for maximum sharpness.
- Hardened for high strength and long usage.
- Softgrip handle with steel cap.
- Surface: Chrome plated finish. Material: Chrome-molybdenum steel.

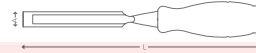

ITEM NO.	5704196+	L MM	A MM	G	
8300-0010	009407	285	10	205	6
8300-0013	009414	285	13	215	6
8300-0016	009421	285	16	225	6
8300-0019	009438	285	19	240	6
8300-0022	209445	290	22	250	6
8300-0025	009452	290	25	260	6
8300-0032	009469	320	32	315	6

#### 8390 WOOD CHISEL SET

- Supplied in plastic holder.



3  
TOOLS

ITEM NO.	5704196+	QTY.	SIZE MM	G	
8390-0003	013091	3	13 - 19 - 25 mm	775	1



**POLAR®**  
MISCELLANEOUS PRODUCTS



# MISCELLANEOUS PRODUCTS

*POLAR® offers a variety of products, including measuring tools, knives, saws, vices, pullers, cable ties and lamps.*

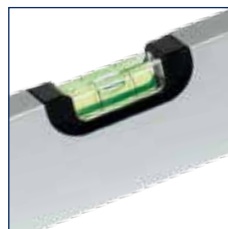
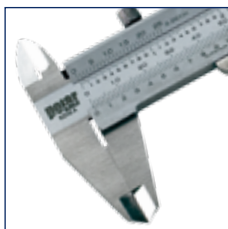
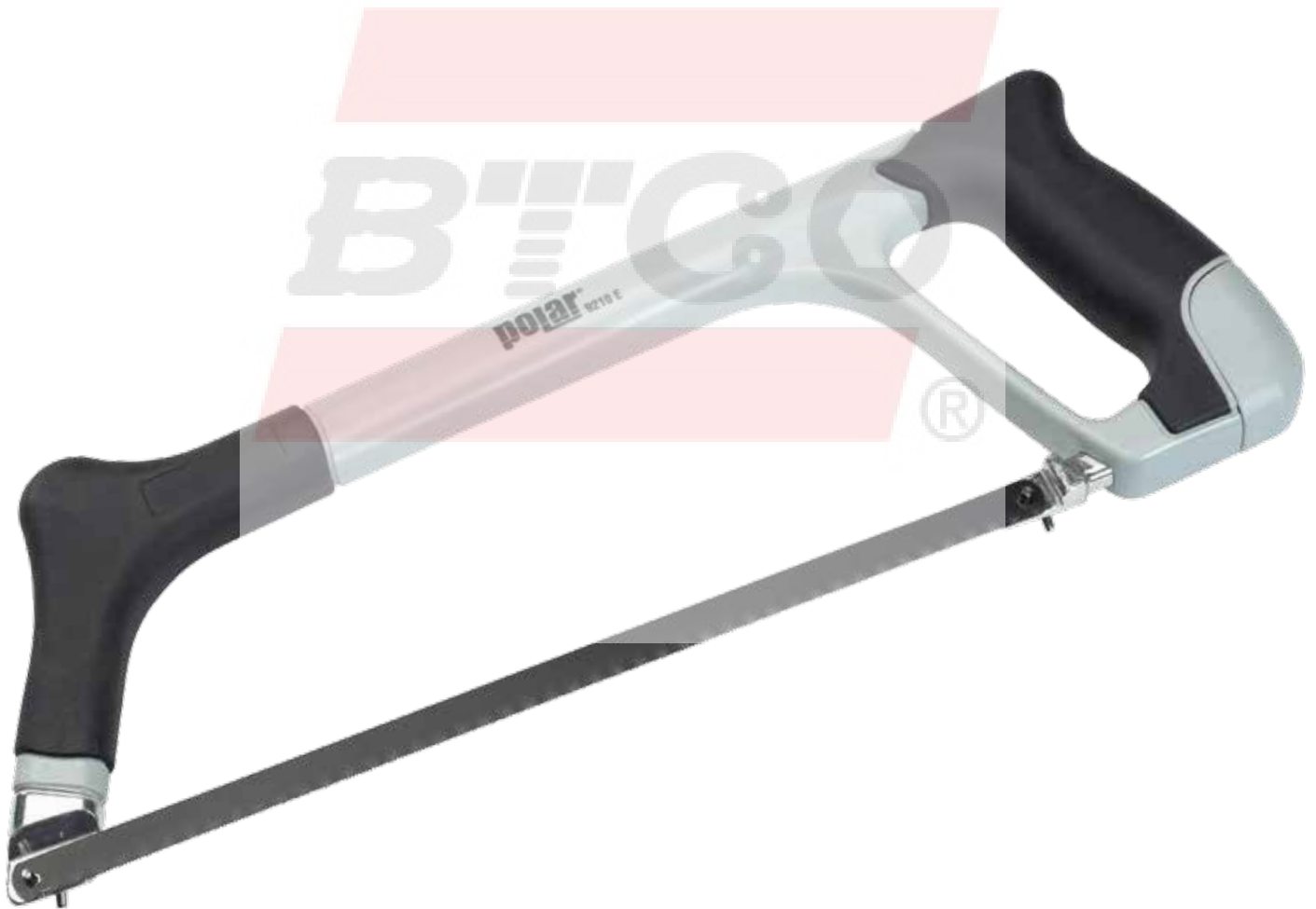



## POLAR® MISCELLANEOUS PRODUCTS



### 8400 BENCH VISES

- Model made of cast carbon steel with anvil.
- Equipped with pipe jaws. Replacable top jaws.
- Surface: Blue hammer paint.
- Model 8400-0075 is supplied with swivel base.

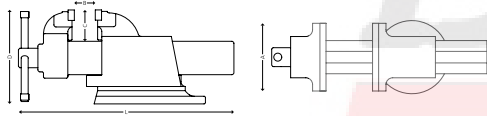

ITEM NO.	5704196+	A MM	B MM	C MM	D MM	L MM	⚖️ G	📦
8400-0075	009940	75	95	50	135	280	4,5	1
8400-0100	009476	100	95	70	125	315	7,3	1
8400-0125	009483	125	145	80	150	410	10,7	1
8400-0150	009490	150	167	100	175	465	17,0	1
8400-0175	020037	175	215	117	210	530	25,0	1

### 8400 SWIVEL BASE FOR BENCH VISE

- Surface: Blue hammer paint.

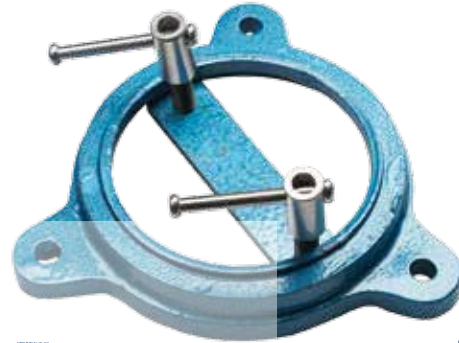

ITEM NO.	5704196+	⚖️ G	📦
8400-1100	020044	0,8	1
8400-1125	020051	1,0	1
8400-1150	020068	1,6	1
8400-1175	020075	1,9	1

### 9000 MAGNETIC TELESCOPIC PICK-UP TOOLS

- Perfect for retrieval of ferrous objects, which are difficult to reach.
- Surface: Chrome plated finish.



ITEM NO.	5704196+	MAX. CAPACITY KG	A MM	L MM	⚖️ G	📦
9000-0016	007564	1,6	11	560	35	25
9000-0022	007571	2,2	13	650	40	25

### 8450 UNIVERSAL PULLERS

- Internal and external model with fixture for use with 2 or 3 legs.
- Spindle made of carbon steel.
- Surface: Chrome plated finish.
- Material: Chrome-vanadium steel.

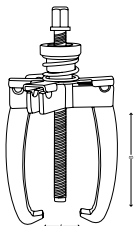

ITEM NO.	5704196+	A MM	B MM	C MM	D MM	⊙ MM	MAX. TORQUE NM	⚖️ G	📦
8450-0102	017365	102	106	15	210	17 mm	90 Nm	1,2	1
8450-0178	017372	175	220	22	300	19 mm	210 Nm	2,6	1



## POLAR® MISCELLANEOUS PRODUCTS

### KNIVES

#### 9101 UTILITY KNIFE

- Professional model with 9 mm snap-off blades.
- Steel blade guide with automatic insert of new blades.
- 4 spare blades inside the handle.
- Comfortable rubber grip.



ITEM NO.	5704196+	L MM	G	12
9101-0009	008288	140	114	12

#### 9115 UTILITY KNIFE

- Model with standard blades.
- Quick change mechanism allows for easy blade removal and blade insert without opening the knife.
- Three different blade positions.
- Includes 5 extra blades inside the handle.
- Comfortable rubber grip.



ITEM NO.	5704196+	L MM	G	12
9115-0010	008332	170	215	12

#### 9101 SB 9 MM SPARE BLADES (10 PCS.)



ITEM NO.	5704196+	SIZE MM	G	50
9101-0910	008295	9 mm	24	50

#### 9115 SB STANDARD SPARE BLADES (10 PCS.)

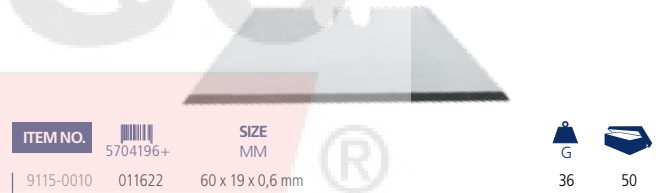

ITEM NO.	5704196+	SIZE MM	G	50
9115-0010	011622	60 x 19 x 0,6 mm	36	50

#### 9105 UTILITY KNIFE

- Professional model with 18 mm snap-off blades.
- Steel blade guide with automatic insert of new blades.
- Adjustment screw to lock the blade.
- 4 spare blades inside the handle.
- Comfortable rubber grip.



ITEM NO.	5704196+	L MM	G	12
9105-0018	008301	170	228	12

#### 9105 SB 18 MM SPARE BLADES (10 PCS.)



ITEM NO.	5704196+	SIZE MM	G	36
9105-1810	008318	18 mm	50	36





## POLAR® MISCELLANEOUS PRODUCTS



### SAWS

#### 9200 M HANDSAW MAXCUT

- Professional handsaw for fine and medium thick materials and plastic tubes.
- TCT-teeth on thick blade for high precision and straight cutting with exceptionally good stability.
- Teflon coating for low-friction and rust protection.
- Ergonomic and shockabsorbing handle.
- Hardened teeth never need resharpener.
- Magnetic teeth protection.



ITEM NO.	5704196+	SIZE MM	SIZE "	TPI	G	1
9200-0550	008356	550	22"	11	460	1

#### 9210 M HACKSAW

- DIN 6473.
- Model for 300 mm blades with possibility of positioning the blade at 90°.
- Screw for regulating blade tension.
- HSS bi-metal steel blade 24 TPI.
- Surface: Enamelled finish.



ITEM NO.	5704196+	BLADE MM	BLADE "	A MM	L MM	G	12
9210-1300	018799	300	12"	130	430	380	12

#### 9210 J HACKSAW JUNIOR

- DIN 6473
- Model for 150 mm blades with possibility of positioning the blade at 45° and 90°.
- Screw for regulating blade tension. 32 TPI steel blade. Ergonomic non-slip grip.
- Surface: Enamelled finish.

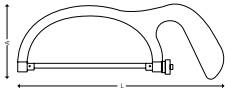
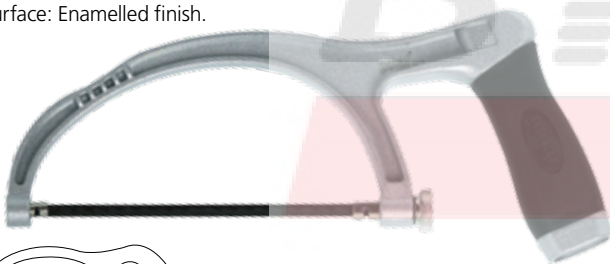

ITEM NO.	5704196+	BLADE MM	BLADE "	A MM	L MM	G	12
9210-0150	008370	150	6"	85	270	215	12

#### 9210 E HACKSAW

- DIN 6473.
- Model for 300 mm blades with possibility of positioning the blade at 45° and 90°.
- Blade tension regulator integrated in the handle.
- Steel body with antislip and shock resistant plastic coating.
- HSS bi-metal steel blade 24 TPI.

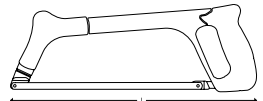

ITEM NO.	5704196+	BLADE MM	BLADE "	A MM	L MM	G	6
9210-2300	018805	300	12"	140	402	580	6

#### 9210 HACKSAW

- DIN 6473.
- Model for 300 mm blades with possibility of positioning the blade at 45° and 90°.
- Screw for regulating blade tension. HSS bi-metal steel blade 24 TPI.
- Surface: Enamelled finish.

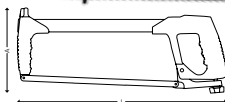

ITEM NO.	5704196+	BLADE MM	BLADE "	A MM	L MM	G	6
9210-0300	008363	300	12"	150	400	595	6

#### 9211 SPARE BLADES

- HSS BI-METAL steel model.



ITEM NO.	5704196+	TPI	L MM	L "	G	QTY. PCS.	1
9211-0001	018607	24	150	6"	6	1	1
9211-0002	008400	24	300	12"	17	2	1
9211-1010	024936	14	300	12"	17	10	1
9211-2010	024943	18	300	12"	17	10	1
9211-0010	008394	24	300	12"	17	10	1

## POLAR® MISCELLANEOUS PRODUCTS



### MEASURING TOOLS

#### 9200 A VERNIER CALIPER

ISO 3599, DIN 862

- Accurate to 0.02 mm (1/50 mm). Inside, outside and depth measurements.
- Vernier with thumb positioning guide.
- Vernier screw lock. Supplied in plastic case.
- Surface: Matt chrome beam and vernier. Material: Stainless steel.

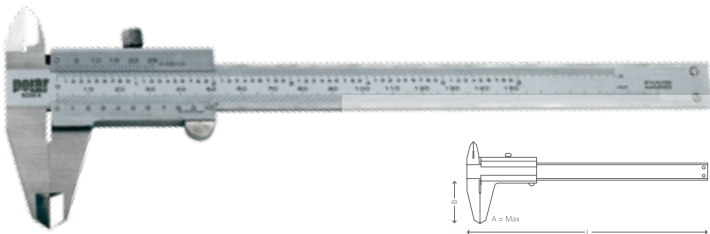

ITEM NO.	5704196+	PRECISION MM/INCH	A MM	B MM	L MM	G	1
9200-0150	009582	0.02 / 0.001	150	40	235	155	1

#### 9400 P TAPE RULE

- Precision class II. Casing of shock resistant ABS with rubbergrip and stainless clip.
- Anti-reflex nylon coated tape of hardened steel.
- Corrosion-, wear- and scratching resistant. Button for tape rewind.
- Rigid up to 2,4 m horizontal and 3,6 m vertical.
- Double graduation in black on yellow background.
- Decimals highlighted in red.

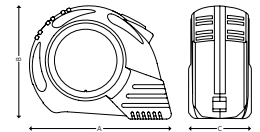

#### 9400 S TAPE RULES

- Precision class II. Casing in steel with rubbergrip and clip.
- Anti-reflex nylon coated tape of hardened steel.
- Corrosion-, wear- and scratching resistant. Two buttons for tape rewind.
- Rigid up to 2,4 m horizontal and 3,6 m vertical.
- Double graduation in black on yellow background.
- Decimals highlighted in red.



**POLAR Xtra**

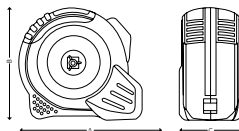

ITEM NO.	5704196+	L M	SCALE	WIDTH MM	AxBxC MM	G	12
9400-0003	009506	3	mm	16	70 x 65 x 30	150	12
9400-0005	009513	5	mm	25	80 x 75 x 38	300	12
9400-0008	009520	8	mm	25	90 x 85 x 40	415	6

ITEM NO.	5704196+	L M	SCALE	WIDTH MM	AxBxC MM	G	12
9400-1005	011257	5	mm	25	93 x 70 x 40 mm	250	12

#### 9400 C TAPE RULE

- Precision class II. Casing in steel with rubbergrip and clip.
- Stainless hook with two magnets. Anti-reflex nylon coated tape of hardened steel.
- Corrosion-, wear- and scratching resistant. Two buttons for tape rewind.
- Rigid up to 1,8 m horizontal and 2,6 m vertical.
- Double graduation in mm and inches, black on yellow background.
- Decimals highlighted in red.



**POLAR Xtra**

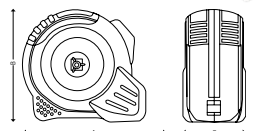

ITEM NO.	5704196+	L M	SCALE	WIDTH MM	AxBxC MM	G	6
9400-2003	017211	3 mtr/10 ft	mm/inches	16	70 x 65 x 30	135	6



### 9410 P TAPE RULE

- Precision class II.
- Casing of shock resistant ABS with rubbergrip.
- Folding winder. Loop with retractable claw.
- Graduation in black on yellow background.
- Decimals highlighted in red.

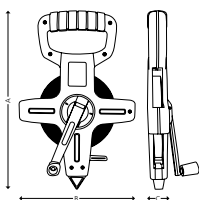

ITEM NO.	5704196+	L M	SCALE	WIDTH MM	A x B x C MM	G	1
9410-0050	008387	50	mm / cm	12	295 x 190 x 40	965	1

### 9500 ALUMINIUM LEVELS

- Precision 0.057° = 1 mm/m
- Supplied with two vertical and one horizontal vial.

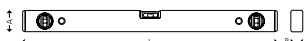

ITEM NO.	5704196+	L M	A M	B M	G	1
9500-0400	009650	400	50	20	245	1
9500-0600	009667	600	50	20	338	1
9500-1200	009681	1200	50	20	632	1

### 9510 TORPEDO LEVEL WITH MAGNET

- Precision 0.057° = 1 mm/m
- Supplied with one vertical, one horizontal and one 45° vial.

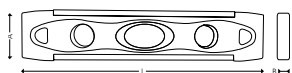

ITEM NO.	5704196+	L M	A M	B M	G	1
9510-0225	009643	225	47	17	153	1



## POLAR® MISCELLANEOUS PRODUCTS

### CABLE TIES

#### 9605 CABLE TIES (100 PCS.)

- UL Flame rating: 94V-2
- Material: Neutral 6/6 nylon
- Operating temperature: -40°C ~ 85°C.

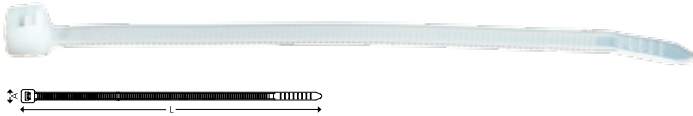

ITEM NO.	5704196+	A x L MM	Ø MAX. MM	MIN. LOOP TENSILE STRENGTH KG	QTY PCS.	
9605-0005	017389	2,5 x 100	22	8,1	100	1
9605-0010	017402	2,5 x 140	33	8,1	100	1
9605-0015	017419	2,5 x 200	53	8,1	100	1
9605-0020	017426	3,6 x 140	33	18,2	100	1
9605-0025	017440	3,6 x 200	53	18,2	100	1
9605-0030	017457	3,6 x 300	76	18,2	100	1
9605-0035	017464	4,8 x 178	40	22,2	100	1
9605-0040	017488	4,8 x 200	50	22,2	100	1
9605-0045	017501	4,8 x 300	76	22,2	100	1
9605-0050	017525	4,8 x 370	102	22,2	100	1
9605-0053	026824	4,8 x 500	145	22,2	100	1
9605-0055	017532	7,6 x 240	63	54,4	100	1
9605-0060	017549	7,6 x 368	102	54,4	100	1
9605-0065	017556	7,6 x 530	140	54,4	100	1
9605-0070	017563	7,6 x 750	218	54,4	100	1
9605-0080	017587	12,6 x 580	152	114,0	100	1

#### 9610 CABLE TIE MOUNTS (100 PCS.)

- Adhesive modell for cable ties up to 4,8 mm width.
- The two largest sizes can be mounted by screws.
- UL Flame rating: 94V-2
- Material: Neutral 6/6 nylon
- Operating temperature: -40°C ~ 85°C.

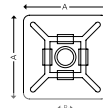

ITEM NO.	5704196+	A MM	B MM	Ø HOLE MM	QTY PCS.	
9610-0010	017808	19,0 x 19,0	4,0	3,6	100	1
9610-0015	017815	27,7 x 27,7	5,3	5,5	100	1

#### 9611 UV CABLE TIE MOUNTS (100 PCS.)

- Adhesive modell for cable ties up to 4,8 mm width.
- The two largest sizes can be mounted by screws.
- UV weather resistant for outdoor application.
- UL Flame rating: 94V-2
- Material: Neutral 6/6 nylon
- Operating temperature: -40°C ~ 85°C.

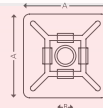

ITEM NO.	5704196+	A MM	B MM	Ø HOLE MM	QTY PCS.	
9611-0005	017822	12,7 x 12,7	3,2	-	100	1
9611-0010	017839	19,0 x 19,0	4,0	3,6	100	1
9611-0015	017846	27,7 x 27,7	5,3	5,5	100	1

#### 9606 UV CABLE TIES (100 PCS.)

- UV weather resistant for outdoor application.
- UL Flame rating: 94V-2
- Material: Neutral 6/6 nylon
- Operating temperature: -40°C ~ 85°C.



ITEM NO.	5704196+	A x L MM	Ø MAX. MM	MIN. LOOP TENSILE STRENGTH KG	QTY PCS.	
9606-0005	017594	2,5 x 100	22	8,1	100	1
9606-0010	017617	2,5 x 140	33	8,1	100	1
9606-0015	017624	2,5 x 200	53	8,1	100	1
9606-0020	017631	3,6 x 140	33	18,2	100	1
9606-0025	017655	3,6 x 200	53	18,2	100	1
9606-0030	017662	3,6 x 300	76	18,2	100	1
9606-0035	017679	4,8 x 178	40	22,2	100	1
9606-0040	017693	4,8 x 200	50	22,2	100	1
9606-0045	017716	4,8 x 300	76	22,2	100	1
9606-0050	017730	4,8 x 370	102	22,2	100	1
9606-0053	026831	4,8 x 500	145	22,2	100	1
9606-0055	017747	7,6 x 240	63	54,4	100	1
9606-0060	017754	7,6 x 368	102	54,4	100	1
9606-0065	017761	7,6 x 530	140	54,4	100	1
9606-0070	017778	7,6 x 750	218	54,4	100	1
9606-0080	017396	12,6 x 580	152	114,0	100	1
9606-0085	022000	12,6 x 1000	305	114,0	100	1

#### 9620 STAINLESS CABLE TIES, TYPE 316 STEEL

- Self locking ball bearing mechanism.
- Material: Stainless steel, type 316.

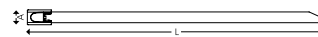

ITEM NO.	5704196+	A x L MM	Ø MAX. MM	MIN. LOOP TENSILE STRENGTH KG	QTY PCS.	
9620-0005	017853	4,5 x 200	50	46	100	1
9620-0010	017860	4,5 x 300	76	46	100	1
9620-0015	017877	4,5 x 370	102	46	100	1
9620-0020	017884	4,5 x 520	156	46	50	1
9620-0025	017891	4,5 x 680	207	46	50	1
9620-0030	017907	4,5 x 840	257	114	50	1



## POLAR® MISCELLANEOUS PRODUCTS



### 9705 RECHARGEABLE COB LED WORK LAMP

ITEM NO. 9705-0001

205 G

5704196 016467

1

- Powerful 270 lumen illumination.
- Strong ABS housing with IP 64 protection.
- The COB LED provides strong and smooth luminous for large area lighting.
- The torch provides intensive and focus luminous for narrow space and long distance lighting.
- Emergency function: Lamp automatically turns on if charging power is interrupted.
- Double switches to control COB and Torch luminous.
- Belt clip, Built-in Magnet and hook for easy carrying and positioning.
- Fast charging, 2.5 hrs.
- Light output: COB = 270 Lm/Torch 2500 LUX (at 0.5 m distance)
- Li-Ion Battery: 3.7V 1900 mAh
- Operating time: COB=100 min. / Torch=180 min
- Charger voltage: 180-240V AC/50-60 Hz
- Charger output: 5 V / 1A

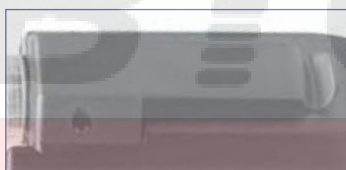



## POLAR® SALES DISPLAYS

### 1900 D DISPLAY STAND

- Supplied with assortment of hooks and logo sign.
- Surface: Black and grey powder coating. Material: 1,2 mm sheet steel casing.

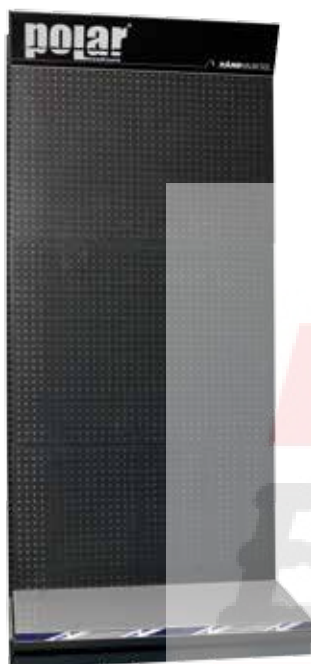

ITEM NO.	5704196+	H MM	W MM	D MM	KG	1
1900-0100	018645	2100	950	500	40,5	1

### 1905 L LOGO STREAMER FOR SHELF

- For 1905 S.



ITEM NO.	5704196+	H MM	W MM	D MM	KG	1
1905-0103	015491	25	905	1	0,01	1

### 1905 L LIGHTNING

- Voltage: 220V/50Hz
- Supplied with 1,5 mtr. cable and fluorescent tube.
- Surface: Black powder coating. Material: 0,8 mm sheet steel casing.



ITEM NO.	5704196+	H MM	W MM	D MM	KG	1
1905-0100	015477	215	915	275	8,0	1

### 1905 S SHELF

- Shelf capacity: 110 kg.
- Surface: Grey powder coating. Material: 1,2 mm sheet steel casing.



ITEM NO.	5704196+	H MM	W MM	D MM	KG	1
1905-0101	016016	30	910	270	3,5	1

### 1910 H HOOKS

- Surface: Zinc-coated. Material: Steel



ITEM NO.	5704196+	Ø x L MM	G	1
1910-0050	015507	3 x 50	14	1
1910-0100	015514	3 x 100	20	1
1910-0150	015521	3 x 150	25	1

### 1905 F SHELF FRONT

- Material: Plexiglass



ITEM NO.	5704196+	H MM	W MM	D MM	KG	1
1905-0102	015484	40	905	3	0,11	1

### 1902 DISPLAY FOR AIR TOOL

- Material: Plexiglass. Supplied with fittings.

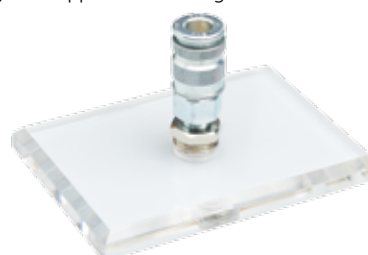

ITEM NO.	5704196+	SIZE "	G	1
1902-0014	027074	1/4"	310	1
1902-0038	027081	3/8"	310	1



## POLAR® SALES DISPLAYS



### 1900 F DISPLAY FOR TOOL SETS

- Supplied with three hooks and logo sign.
- Surface: Black powder coating. Material: Steel structure.

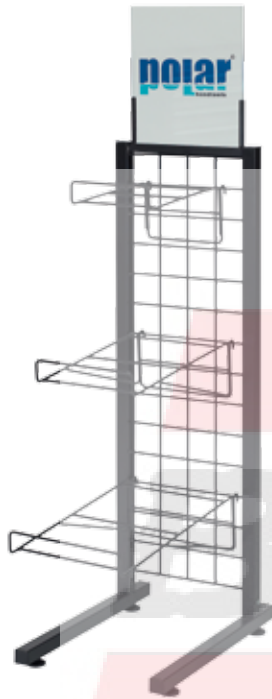

ITEM NO.	5704196+	H MM	W MM	D MM	KG	1
1900-0500	016009	1350	330	470	8,5	1

### 4590 SB/20 BITS SET

- Supplied in sales display.
- Content: 20 Bits sets, 4590 EC 1/4"

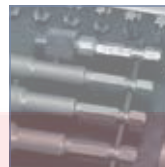

ITEM NO.	5704196+	DIMENSIONS MM
4590-2024	014876	350 x 410 x 110 mm

KG	1
8,9	1

### 5090 S/20 METRIC SOCKET WRENCH SET

- Supplied in sales display.
- Content: 20 Metric socket wrench sets, 5090 1/4" HC



ITEM NO.	5704196+	DIMENSIONS MM
5090-2023	014890	350 x 410 x 110

KG	1
10,1	1

### 4590 SA/20 BITS SET

- Supplied in sales display.
- Content: 20 Bits sets, 4590 A 1/4"



ITEM NO.	5704196+	DIMENSIONS MM	KG	1
4590-2031	011202	345 x 255 x 105 mm	5,5	1



## POLAR® SALES DISPLAYS



### 4090 S/50 SCREWDRIVER SET

ITEM NO. 4090-0050

- Supplied with plexiglas display.

**CONTENT:**

QTY.	DESCRIPTION	SIZE
5	Screwdrivers for slotted head screws	4000 3 x 75 mm
5	Screwdrivers for slotted head screws	4000 4 x 100 mm
5	Screwdrivers for slotted head screws	4000 5,5 x 125 mm
5	Screwdrivers for slotted head screws	4000 6,5 x 150 mm
5	Screwdrivers for slotted head screws	4000 8 x 175 mm
5	Screwdrivers for Phillips® head screws	4010 PH 0
5	Screwdrivers for Phillips® head screws	4010 PH 1
5	Screwdrivers for Phillips® head screws	4010 PH 2
5	Screwdrivers for Pozidriv® head screws	4020 PZ 1
5	Screwdrivers for Pozidriv® head screws	4020 PZ 2

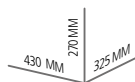

- 5,6 KG
- 5704196 013923
- 1



### 9190 S/39 UTILITY KNIVES SET

- Supplied in sales display.
- Content:
  - 27 Utility knives, 9 mm (item no. 9101)
  - 12 Utility knives, 18 mm (item no. 9105)



### 9490 S/24 TAPE RULES SET

- Supplied in sales display.
- Content:
  - 8 Tape Rules, 3 mtr. (item no. 9400)
  - 8 Tape Rules, 5 mtr. (item no. 9400)
  - 8 Tape Rules, 8 mtr. (item no. 9400)



ITEM NO. 5704196+  
9190-0030 015828

DIMENSIONS  
MM  
280 x 330 x 55 mm

KG 6,2  
1

ITEM NO. 5704196+  
9490-0024 015835

DIMENSIONS  
MM  
290 x 395 x 95 mm

KG 7,4  
1



**POLAR®**  
POLAR COLLECTION



# POLAR COLLECTION

The POLAR® Collection covers a range of promotional products and merchandise.  
We do not compromise with quality – you will always get our well known quality, also for gear and merchandise.

## 1005 R KNEELING MAT

- Oilproof EVA/PE foam.

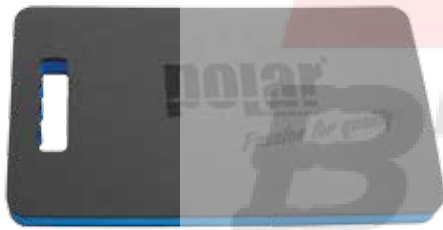

ITEM NO.	5704196+	H MM	W MM	D MM	G	Icon
R1005-1000	021911	30	435	230	146	1

## 4020 POLAR MUG

- Dishwasher safe.



ITEM NO.	5704196+	G	Icon
R4020-0001	026978	326	1

## 4000 POLAR PEN

- With pocket clip.



ITEM NO.	5704196+	G	Icon
R4000-0100	026886	10	100

## 4000 LETTER OPENER



ITEM NO.	5704196+	G	Icon
R4000-0000	026862	72	1

## 4000 PAPER BLOCK

- Squared paper.
- Size: 105 x 148 mm



ITEM NO.	5704196+	G	Icon
R4000-0200	026893	68	5

## 1000 POLAR MENTOS

- Classic Mint.



ITEM NO.	5704196+	G	Icon
R1000-0010	026855	2	100



## POLAR® POLAR COLLECTION

### 4000 PLASTIC BAG



ITEM NO. 5704196+  
R4000-0050 026879

G   
18 500

### 4010 POSTER

■ Including hanging rails.



ITEM NO. 5704196+  
R4010-0005 026947

SIZE  
CM  
50 x 70

G   
500 1

### 4002 STICKERS

■ Vinyl quality.



ITEM NO. 5704196+  
R4002-0001 026909  
R4002-0002 026916  
R4002-0003 026923

SIZE  
MM  
80 x 40  
50 x 120  
80 x 180

G   
0,7 10  
1,4 10  
3,4 10

### 4010 ROLL UP

■ Supplied in a carrying bag.



ITEM NO. 5704196+  
R4010-0010 026954

SIZE  
CM  
85 x 200

G   
4 1

### 4002 FACE ADHESIVE STICKER

■ For shop windows (glue on printside for inside use)  
■ Vinyl quality.



ITEM NO. 5704196+  
R4002-0010 026930

SIZE  
MM  
310 x 130 mm

G   
7 1



## POLAR® POLAR COLLECTION



### 4010 BANNER

- Outdoor PVC banner with reinforced edges.



ITEM NO.	5704196+	SIZE CM
R4010-0030	026961	100 x 200

KG	
5	1

### 4030 POLAR EXHIBITION COUNTER

- Folding exhibition counter in aluminum.
- Supplied in a carrying bag.

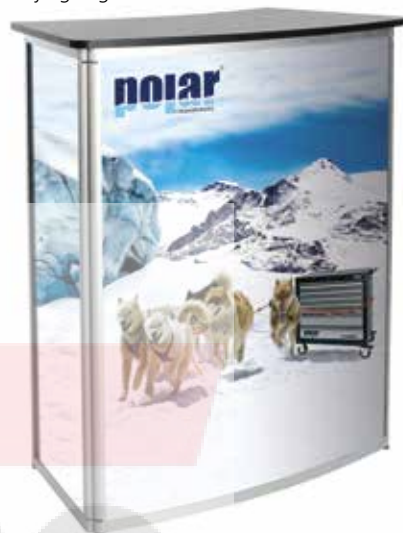

ITEM NO.	5704196+	H CM	W CM	D CM	KG	
R4030-0010	027005	90	80	42	10	1

### 4025 BEACH FLAG

- Beach flag including bag and base plate.



ITEM NO.	5704196+	SIZE CM
R4025-0001	026985	88 x 200

KG	
5	1

### 4030 POLAR TABLE DISPLAY



ITEM NO.	5704196+	SIZE MM	G	
R4030-0005	026992	210 x 297 (A4)	300	1



## POLAR® INFORMATION

# POLAR TOOLS A/S

# SYMBOLS



Weight



Packaging (inner carton)



EAN code



Go-through blade



ACR profile



VDE tested, voltage with stand  
strenght up to 1000 volt



Slotted



6-Point (Sockets)



Phillips®



12-Point (Sockets)



Pozidriv®



Torx® (Sockets)



Torx®



Hexagon (Bit sockets)



Tamper Resistant Torx®

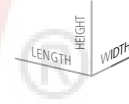

Dimensions (L x H x W)



Hexagon



Square



Tools with added value

### HEAD OFFICE - DENMARK

Polar Tools A/S  
Soldalen 9 . 7100 Vejle . Denmark  
Phone: +45 7584 1122  
Mail: info@polartools.com

### CUSTOMER SERVICE

Phone: +45 7584 1122  
Mail: sales@polartools.com

### WAREHOUSE

Polar Tools A/S  
Bødkervej 2 . 7100 Vejle . Denmark  
Phone: +45 7584 1122  
Mail: info@polartools.com

### GENERAL INFORMATION

*This POLAR® catalogue cancels all previous catalogues. We reserve the right to make changes in design or construction at any time without incurring any obligation in incorporating such changes in tools or equipment previously sold. We also reserve the right to discontinue the manufacture or offering for sale through POLAR® dealers of any tools or equipment at such time as we consider necessary.*

*Dimensions shown in this catalogue have been rounded to the nearest fractional size or nearest tenth millimeter and are not exact product specifications. Ask your local POLAR® representative or POLAR® customer service for product specifications if required.*

*We cannot accept the responsibility for the results of using tools which have been abused or badly worn, such as punches and chisels mushroomed by hammer blows, or the incorrect use of tools, or tools repaired by others. The catalogue is distributed by POLAR® and all items may be available in each country. For detailed information about the availability and pricing, please contact your local POLAR® representative or POLAR® customer service.*

*Copyright: All text, photos and illustrations are protected by copyright. No part of this material may be reproduced without written permission from Polar Tools A/S.*



# POLAR® NUMERICAL CONTENT



**ARTICLE PAGE**

1000.....23-29, 82  
1005.....30  
1010.....31  
1011.....32-33  
1050.....30  
1090.....23  
1091.....38-49  
1092.....83  
1100.....78  
1110.....78  
1120.....79-80  
1125.....80  
1200.....82  
1300.....81  
1345.....81  
1350.....81  
1800.....50  
1801.....50  
1802.....50  
1804.....51  
1805.....51  
1807.....52  
1808.....52  
1809.....52  
1810.....53  
1811.....53  
1812.....53  
1813.....54  
1814.....54  
1815.....55  
1816.....55  
1817.....55  
1818.....55  
1819.....56  
1820.....56  
1821.....56  
1822.....56  
1823.....57  
1824.....57  
1825.....57  
1826.....57  
1827.....58  
1828.....58  
1829.....58-59  
1830.....59-60  
1831.....60  
1832.....61  
1833.....61  
1834.....61  
1835.....62  
1836.....62  
1837.....62  
1838.....62

**ARTICLE PAGE**

1839.....63  
1840.....63  
1841.....63  
1842.....64  
1843.....64  
1844.....65  
1845.....65  
1846.....65  
1847.....65  
1848.....66  
1849.....66  
1875.....67-77  
1900.....176  
1902.....176  
1905.....176  
1910.....176  
2000.....85-86  
2005.....87  
2010.....87  
2070.....88  
2090.....85-86  
2091.....87-88  
2095.....87-88  
2100.....88  
2110.....89  
2195.....89  
2200.....90  
2290.....90  
2400.....90  
2405.....91  
2490.....90  
2495.....91  
2600.....91  
2602.....92  
2610.....92  
2690.....91  
3001.....101,104  
3002.....101,104  
3004.....101,104  
3005.....101,104  
3006.....101,104  
3009.....101,104  
3010.....105  
3011.....105  
3020.....102,105  
3050.....102  
3090.....102  
3091.....105  
3100.....106  
3105.....106  
3110.....106  
3115.....106  
3190.....106

**ARTICLE PAGE**

3200.....107  
3202.....107  
3203.....107  
3205.....107  
3210.....107  
3215.....107  
3220.....108  
3400.....108  
3500.....108  
3900.....109  
3901.....109  
3902.....109  
3903.....109  
3904.....109  
3990.....109  
4000.....112  
4001.....112  
4003.....112  
4010.....112  
4011.....112  
4013.....112  
4020.....113  
4021.....113  
4023.....113  
4030.....116  
4031.....115  
4035.....116  
4042.....116  
4043.....116  
4045.....119  
4090.....113-116, 178  
4091.....114-115  
4100.....121  
4105.....121-122  
4131.....122  
4190.....122-123  
4195.....122-123  
4200.....117  
4202.....117  
4210.....117  
4220.....117  
4290.....118  
4400.....119  
4410.....119  
4430.....119  
4431.....119  
4490.....120  
4514.....124-125  
4516.....130-131  
4590.....126-129, 177  
4614.....129  
4712.....131, 145  
4714.....130, 135

**ARTICLE PAGE**

4790.....131  
4814.....130  
5012.....140-141  
5014.....134  
5034.....147  
5038.....138  
5090.....8-16, 141, 177  
5112.....142-144  
5114.....135  
5190.....143-144  
5191.....17-19, 143-144  
5212.....145  
5214.....136  
5234.....147  
5238.....138-139  
5312.....146  
5314.....137  
5334.....147  
5338.....139  
5412.....145  
5414.....136  
5434.....147  
5438.....139  
5514.....136  
5612.....145  
5614.....136  
5638.....139  
5712.....145  
5734.....147  
5738.....139  
5812.....146  
5814.....136  
5838.....139  
5912.....146  
5934.....147  
6012.....158, 160-161  
6090.....158-160  
6100.....150-152, 161  
6105.....153  
6110.....154  
6113.....156  
6115.....156  
6120.....155  
6125.....1155  
6127.....156  
6130.....157  
6135.....156  
6137.....157  
6212.....160  
6638.....160  
6734.....160  
6812.....161  
6910.....161

**ARTICLE PAGE**

7100.....94  
7300.....94  
7400.....95  
7514.....97  
7614.....95-96  
7638.....95  
7690.....96  
7700.....97-98  
7800.....98-99  
7801.....98  
7802.....99  
7803.....98  
8010.....163  
8020.....163  
8030.....163  
8040.....164  
8060.....164  
8070.....164  
8200.....165  
8205.....166  
8210.....166  
8215.....166  
8220.....166  
8290.....165-167  
8300.....167  
8390.....167  
8400.....168  
8450.....169  
9000.....169  
9101.....170  
9105.....170  
9115.....170  
9190.....178  
9200.....171-172  
9210.....171  
9211.....171  
9400.....172  
9410.....173  
9490.....178  
9500.....173  
9510.....173  
9605.....174  
9606.....174  
9610.....174  
9611.....174  
9620.....174  
9707.....175  
P1000.....34-35  
P1005.....35



مركز البراغي والعدد  
**BOLTS & TOOLS CENTER** **BTGO**