



TECHNOLOGY FOR FLUIDYNAMICS

مركز البراغي والعدد
BTCO
BOLTS & TOOLS CENTER



FLUID CONTROL SYSTEM



CE Made in Italy



The FCS is an integrated system for **managing and controlling the dispensing** of fluids in maintenance facilities.

Highly versatile and intuitive, **it allows customised configurations** in order to fully adapt to the customer's needs.

- ▶ **automatic control of fluid inventories**
- ▶ **display with simple and intuitive menu**
- ▶ **optional summary ticket for each action**
- ▶ **ability to connect to personal computer**
- ▶ **dispensing authorised by means of access code**

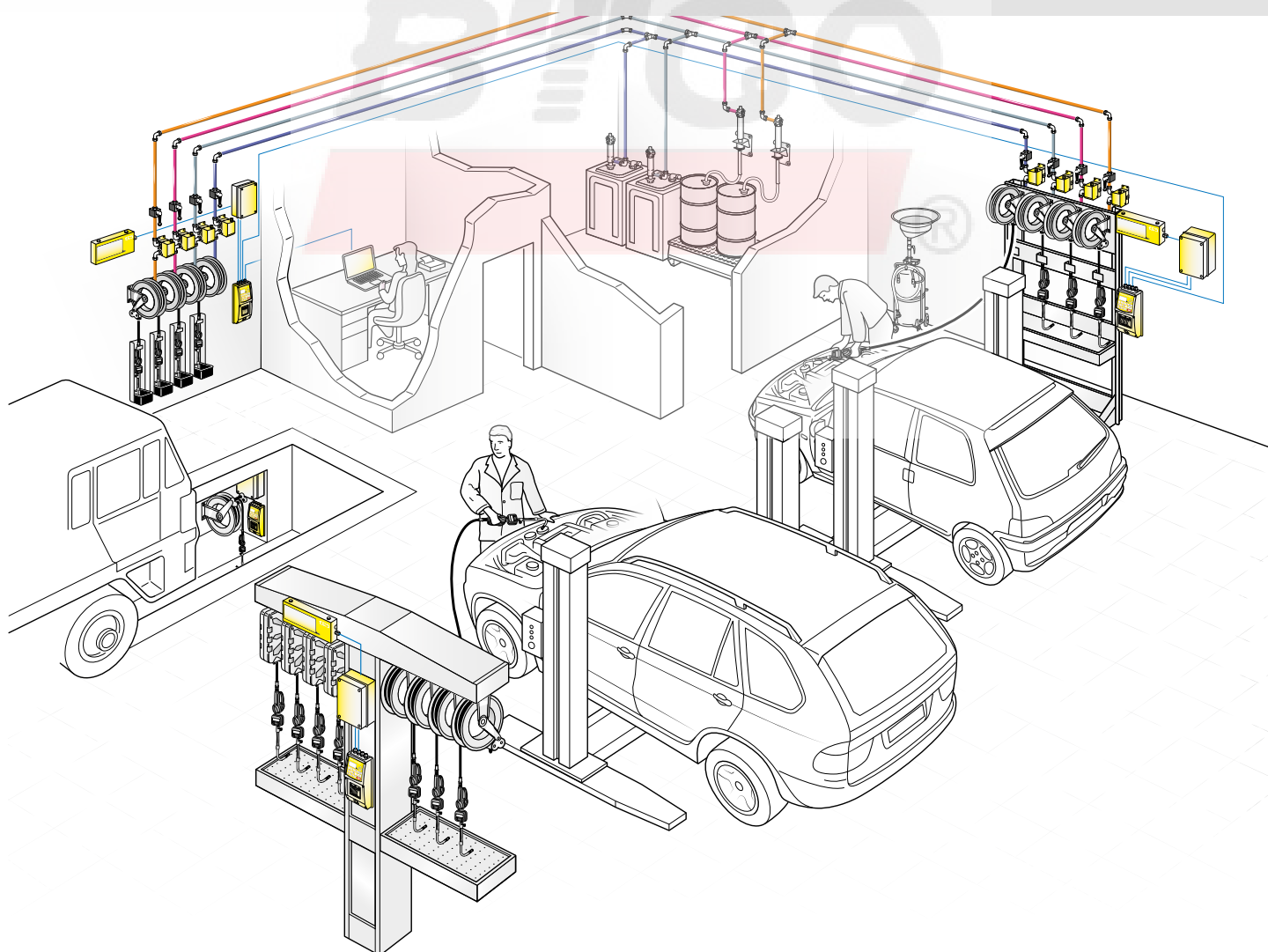

esempio di impianto FCS

FLUID CONTROL SYSTEM

can manage:



▶ OPERATORS

The FCS can be used by a maximum of 1000 authorized operators, who can access the system by entering a numerical password, or by using the "i-button" key. All the operations carried out, such as dispensing, filling and draining fluids, calibration, etc., are stored in the system's memory.

▶ TANKS

The FCS can manage up to a maximum of 50 tanks, which are progressively numbered and associated with the type of fluid contained. The quantity of fluid inside each tank is constantly calculated by the system. Also, special reserve and delivery blocking alarms, or optional level gauge probes, prevent going below a minimum level fixed by the user.

▶ FLUIDS

The FCS can manage up to a maximum of 50 types of fluids. Each fluid is distinguished by the complete name and an abbreviation (6-digit), which simplifies the analysis of dispensing operations carried out by the system. The quantities dispensed are counted with the unit of measure chosen by the user: Liters, Gallons, Quarts, Pints.

▶ DISPENSERS (OUTLETS)

The FCS manages up to a maximum of 1188 dispensing points (99 control units x 12 outlets). Each Operator Control Unit (OCU) can manage a maximum of 12 outlets, 6 of which are able to work at the same time. The date and time, operator's name, order number or vehicle number-plate, type of fluid and quantity dispensed are recorded for each dispensing operation. All these details can be printed on tickets.

▶ DATA BASE

The internal memory of the OCU allows the recording of up to a maximum of 4000 operations. When connected to a PC, dedicated software supplied with the FCS enables data management and customization of the system, as well as sending the stored data.

FCS software

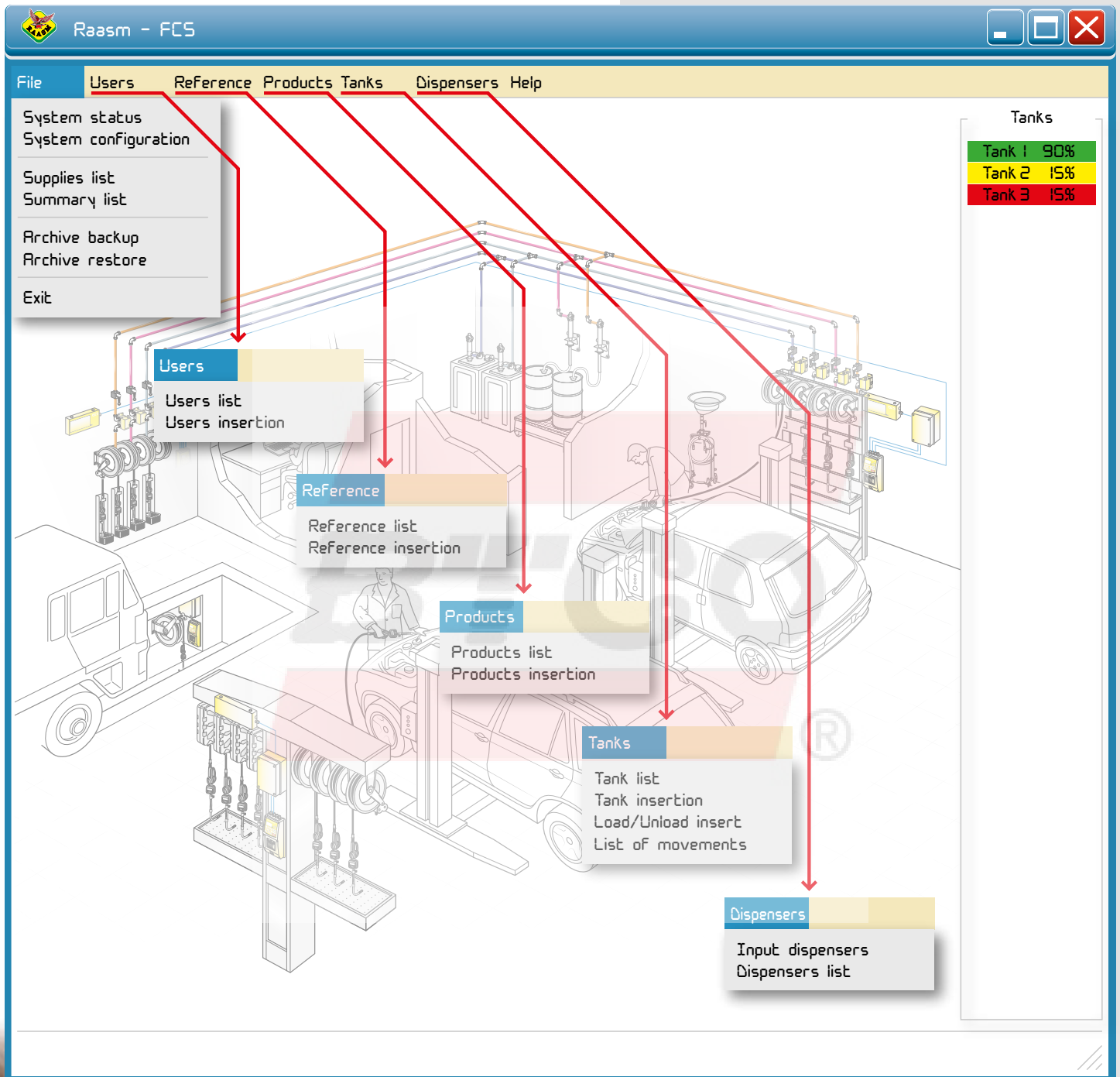

► FCS SOFTWARE

The FCS software is both sophisticated and easy to use. The system is simple to configure for accurately managing tanks, operators, dispensers, fluids and more. The FCS software also provides tools for analyzing your fluids consumption.

Operator Control Unit: Menu

▶ The Operator Control Unit allows the administrator to access to a detailed menu where personalized configurations can be entered and the entire system managed. If the Operator Control Unit is connected with a computer most of the operations shown above can be managed through the FCS software (see page aside).



- 0) PC/INDEPENDENT SET
- 2) MEASURING UNIT
- 3) FLUIDS
- 4) TANKS
- 5) DISPENSERS
- 6) OPERATORS AND ADMIN
- 7) LANGUAGE
- 8) SET DATE AND TIME
- 9) CALIBRATION
- 10) REFERENCE NUMBER
- 11) MEMORY
- 12) DISPENSERS TIME
- 13) PRESET
- 14) SET VALVES
- 15) SET PRINT
- 16) FCS UNIT NUMBER
- 17) SYSTEM INFO
- 18) OPERATOR ID
- 19) WASTE OIL LEVEL

▶ Every delivery can be summarized by a printed ticket (optional) which shows the most important information recorded by the system.

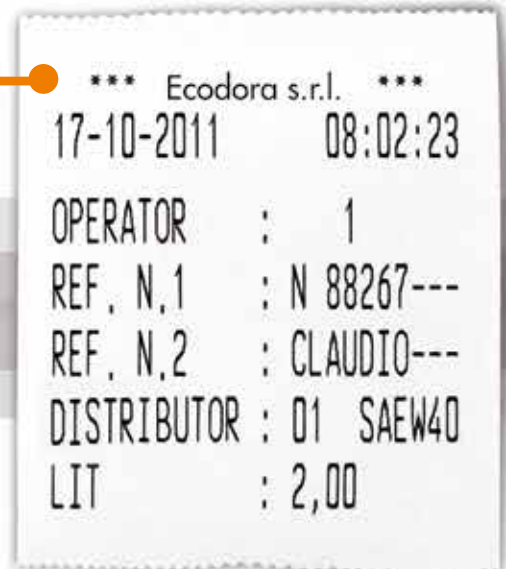

Wiring Diagram FCS

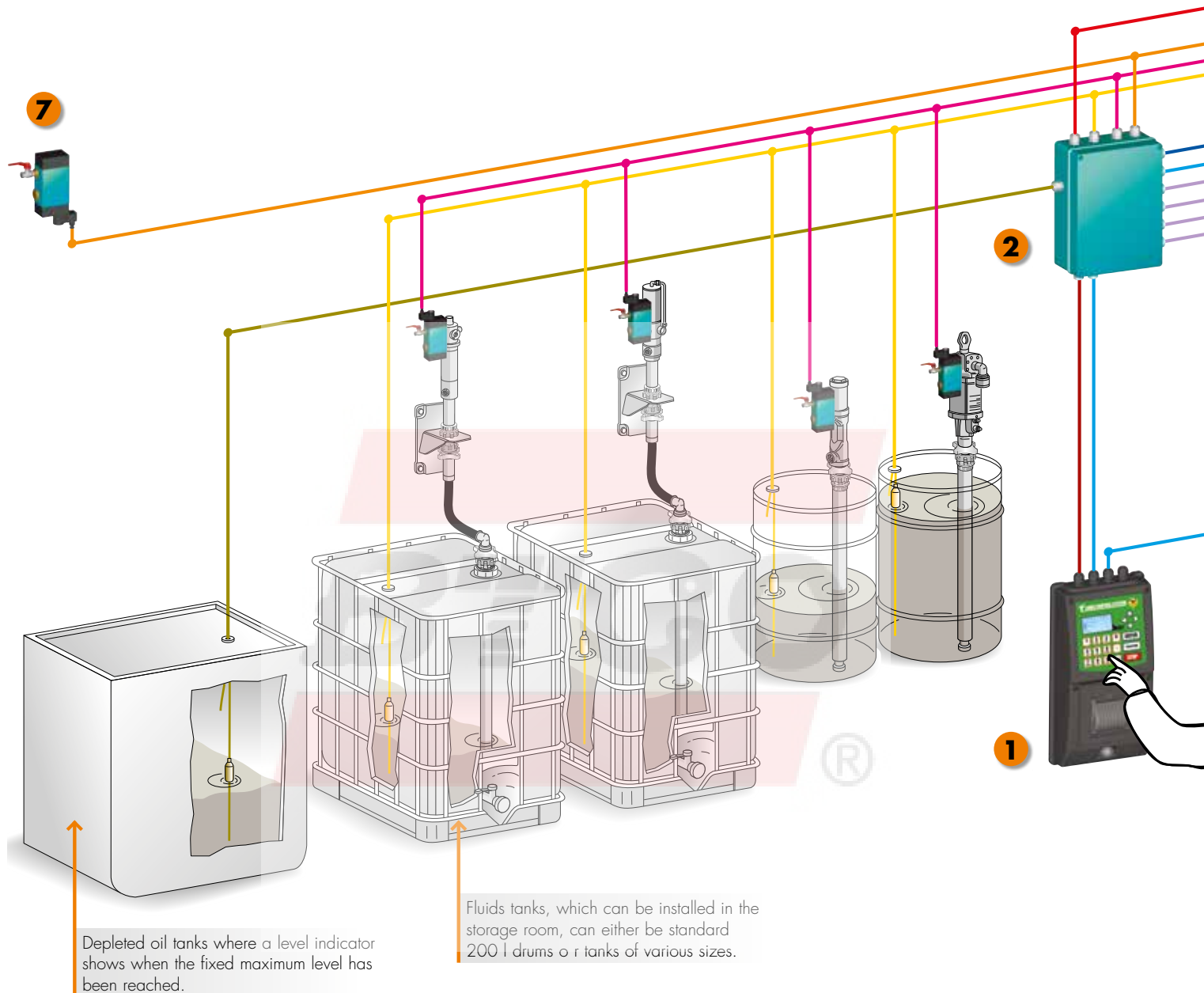

P/N 0E39599 OPERATOR CONTROL UNIT (OCU)

The OCU is installed near the dispensing points and allows operators to communicate with the system by means of the special membrane keypad and large display.

There is an optional printer for tickets.

Important: for operation, each OCU must be connected to a DMU.

P/N 0E39598 OPERATOR CONTROL UNIT (OCU)

Like P/N 0E39599 but without printer for ticket.

System functionality:

- ▶ Access to the system by means of PIN code or I-button device
- ▶ Possibility of installing external bar code or badge reader
- ▶ Customizable ticket printout at the end of each dispensing operation (version with printer)
- ▶ Up to 1000 authorized operators
- ▶ Memory holds up to 4000 operations
- ▶ Possibility of free dispensing or preset amount
- ▶ Individual calibration of each single dispenser
- ▶ Large graphic display with intuitive and easy to scroll through menu
- ▶ Possibility of connecting the system to a PC
- ▶ Up to 6 simultaneous deliveries (when connected with 3 DMUs)
- ▶ It is possible to manage up to 12 dispensers when using 3 DMUs.

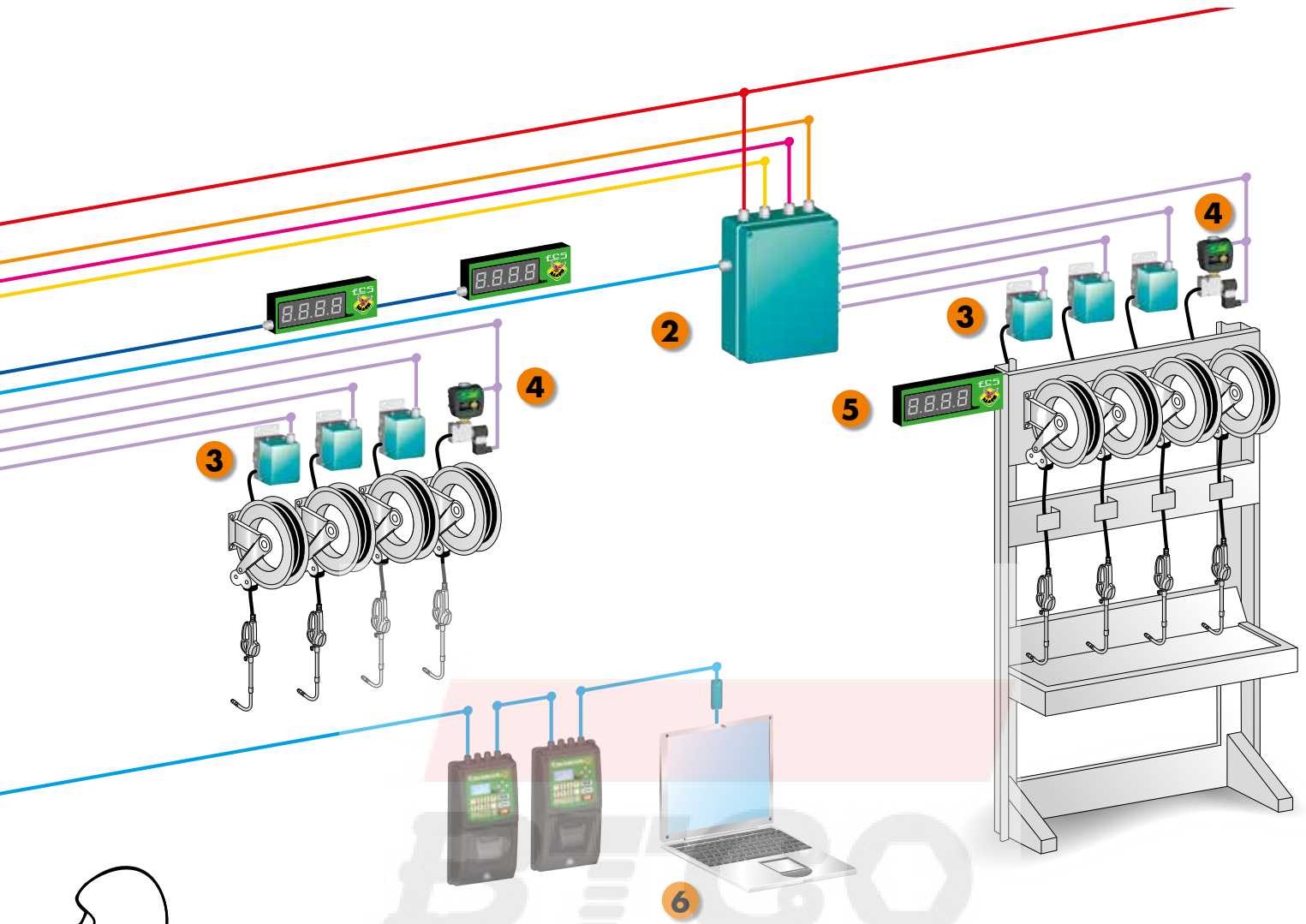

CABLE	DESCRIPTION	LENGTH
	Power cable 110 V - 230 V	max 100 m
	Cable for connecting main air supply solenoid valve to DMU	max 100 m
	Cable for connecting air supply solenoid valve to DMU	max 100 m
	Cable for connecting level indicator to DMU	max 1000 m
	Cable for connecting remote display to DMU	max 30 m
	Cable for connecting OCU to DMU and successive DMU's Cable for connecting OCU to PC and other OCU's	max 1000 m
	Cable for connecting depleted oil level indicator to DMU	max 1000 m
	Cable for connecting DMU to PDV or PSV	max 30 m
	Power cable 24 V - D.C.	max 100 m

2



P/N OE39605 DISPENSER MANAGEMENT UNIT (DMU)

As well as sending commands to all the components of the system, the Dispenser Management Unit (DMU) ensures the low voltage (24 V - D.C.) power supply. It contains all the electrical connections for the system. Each DMU directly controls up to 4 dispensers.

If 5-8 dispensers are to be controlled, a second DMU can be connected to the first, thereby enabling a single OCU to control 8 dispensers. For controlling 9-12 dispensers, a third DMU can be connected to the first, (see installation examples on the following pages).

DMU characteristics:

- ▶ Powered by 110 V - 230 V - A.C., it supplies the 24 V - D.C. feed to all the components of the system
- ▶ Can control up to 4 dispensers which are each connected to a pulser-valve unit (PDV or PSV)
- ▶ Enables the simultaneous use of 2 dispensers per unit
- ▶ Max. distance between DMU and pulser-valve: 30 m.
- ▶ Suitable to be connected with 4 oil level gauges and 1 waste oil level gauge
- ▶ 4 Air solenoid valves (one for each pump), or 1 general air solenoid valve, may be connected with the DMU to pressurize the pumps only during use
- ▶ 2 remote displays may be connected with the DMU.

3



P/N OE39630 PULSER DOUBLE VALVE (PDV)

The PDV is installed along the pipe that takes the fluid from the pump to the dispensing points. It closes the supply line, acting as a valve that opens when receiving consent from the DMU to which it is connected. It also measures the product flowing through the pipe, immediately sending the data to the DMU which feeds it with 24 V - D.C. The double valve offers greater precision in measuring the dispensed fluid, by reducing the flow before reaching the preset quantity. Inlet and outlet connections 1/2" F.

4



P/N OE39620 PULSER SINGLE VALVE (PSV) FOR OIL 1/2"

The Pulsar in single valve version for oil, with 1/2" connections, as an alternative to the double valve version PDV.

P/N OE39623 PULSER SINGLE VALVE (PSV) FOR OIL 3/4"

The Pulsar single valve version for oil with 3/4" connections.

P/N OE39621 PULSER SINGLE VALVE (PSV) FOR ANTIFREEZE 1/2"

The Pulsar single valve version for antifreeze and window washing liquid with 1/2" connections.

P/N OE39624 PULSER SINGLE VALVE (PSV) FOR DIESEL 3/4"

The Pulsar single valve version for gas oil with 3/4" connections.

▶ All the PSV's are fed by the DMU 24 V - D.C.

5



P/N OE39640 REMOTE DISPLAY (LCD)

The remote display allows the dispensed quantities to be viewed from a distance. It is possible to connect 2 remote displays for each DMU.

▶ Fed by DMU 24 V - D.C.

6



P/N OE39680 KIT PERSONAL COMPUTER (KIT PC)

The PC Kit enables a personal computer to centralize and manage the system. It comprises a USB signal converter to connect the FCS Module to the PC and installation software on a CD ROM. The software has been designed to manage all necessary operations to control dispensing, including but not limited to: system configuration, operator setup, and checking inventory.

P/N OE39681 SOFTWARE FOR NETWORK OF COMPUTERS

Software to create a network of computer connected with FCS. Using this software each computer will be able to interact directly with the system.

it manages:

▶ Max. 1000 operators ▶ Max. 50 tanks ▶ Max. 50 products ▶ Max. 5000 reference numbers (or order numbers) ▶ Can set unit of measure to liters, gallons, quarts or pints (liters set as default) ▶ Tank block level ▶ Tank alarm level ▶ Max. 1188 controlled outlets ▶ Windows compatible software ▶ Data can be exported as an .xls or .txt file for compatibility with other management software ▶ Can dispense directly from your PC ▶ Can preset multiple dispensing quantities, which are identified by a "Refnumber" ▶ Displays remaining stock in real-time for every tank and can graph the trend of remaining stocks over time.

8



P/N OE39685

Converter USB-RS232/RS485, to connect OCU with personal computer.

P/N OE39690

"I BUTTON" device allows operators communicate with the system. It is an alternative to PIN code.



P/N OE39650

Low level gauge h 860 mm, suitable for 180 - 220 Kg drums, to be connected with FCS.

P/N OE39651

Low level gauge h 1300 mm, suitable for tanks, to be connected with FCS.

P/N OE39652

Low level gauge h 1500 mm, suitable for tanks, to be connected with FCS.

P/N OE39655

High level gauge for waste oil, suitable to be connected with FCS.



P/N OE39610

Pulser meter for oil with inlet/outlet 1/2" is used to measure fluids and to transmit data. It is usually installed on centralized lubrication system to control and manage delivery of fluids.



P/N OE39611

Pulser meter for antifreeze and windscreen washing liquid with inlet/outlet 1/2" is used to measure fluids and to transmit data. It is usually installed on centralized lubrication system to control and manage delivery of fluids.



P/N OE39613

Pulser meter for oil with inlet/outlet 3/4" is used to measure fluids and to transmit data. It is usually installed on centralized lubrication system to control and manage delivery of fluids.



P/N OE39614

Pulser meter for diesel with inlet/outlet 3/4" is used to measure fluids and to transmit data. It is usually installed on centralized lubrication system to control and manage delivery of fluids.

ACCESSORIES FOR OIL ROOM



P/N OE39280

Timer 24 V D.C. with daily and weekly programming for programmed activation of air solenoid valves 24 V - D.C. connected with all the pneumatic pumps.



P/N OE39281

Feeder 220 - 24 V D.C. - 6A. It provides power supply to all the accessories for the oil room.



P/N OE39282

Automatic manual-selector 24 V D.C. for feeding solenoid valves, to activate every pump.

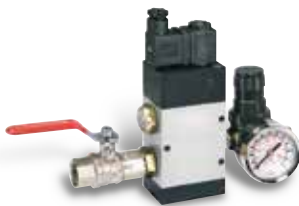

P/N OE39284 PNEUMATIC SOLENOID VALVE 1/4"

The pneumatic solenoid valve 24 V - D.C. with FxF 1/4" connections, equipped with pressure regulator 0-8 bar, controls the opening and/or closing of the compressed air supply for each single pump mounted on fluid tanks. The connected DMU controls when it opens.

P/N OE39285 PNEUMATIC SOLENOID VALVE 1/2"

The pneumatic solenoid valve 24 V - D.C. with FxF 1/2" connections, equipped with pressure regulator 0-8 bar, controls the opening and/or closing of the compressed air system that feeds the pumps mounted on fluids tanks.

7



P/N OE39286 PNEUMATIC SOLENOID VALVE 1/4"

The pneumatic solenoid valve 24 V - D.C. with FxF 1/4" connections controls the opening and/or closing of the compressed air supply for each single pump mounted on fluid tanks. The connected DMU controls when it opens.

P/N OE39287 PNEUMATIC SOLENOID VALVE 1/2"

The pneumatic solenoid valve 24 V - D.C. with FxF 1/2" connections controls the opening and/or closing of the compressed air system that feeds the pumps mounted on fluids tanks.



P/N OE39289

Luminous acoustic flashing light, connected with a level gauge, signals exhaustion of fluids.



P/N OE39290

Electric line main stop push button for all the accessories in the oil room.

Installation examples

SYSTEM CHARACTERISTICS

FCS comprising a operator control unit without ticket printer connected to DMU with 4 dispensers. Connection to a PC not present

n° 1	OCU with ticket printer	P/N OE39599
n° 1	DMU	P/N OE39605
n° 4	PDV	P/N OE39630
n° 4	Dispensing points	-

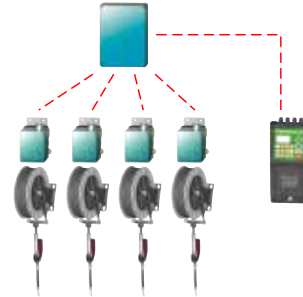

SYSTEM CHARACTERISTICS

FCS comprising 2 control units, the first connected to 2 DMU's with 7 dispensers and remote display; the second connected to DMU with 4 dispensers. The system is connected to a PC

n° 2	OCU with ticket printer	P/N OE39599
n° 3	DMU	P/N OE39605
n° 11	PDV	P/N OE39630
n° 1	LCD	P/N OE39640
n° 1	Kit PC	P/N OE39680
n° 11	Dispensing points	-

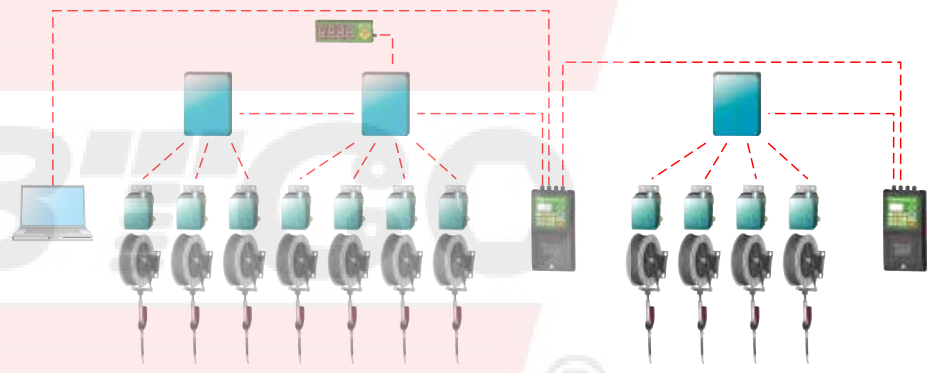

SYSTEM CHARACTERISTICS

FCS comprising 3 control units, each connected to a different number of dispensers by means of DMU. Remote displays present. The system is connected to a PC

n° 3	OCU with ticket printer	P/N OE39599
n° 7	DMU	P/N OE39605
n° 24	PDV	P/N OE39630
n° 5	LCD	P/N OE39640
n° 1	Kit PC	P/N OE39680
n° 24	Dispensing points	-

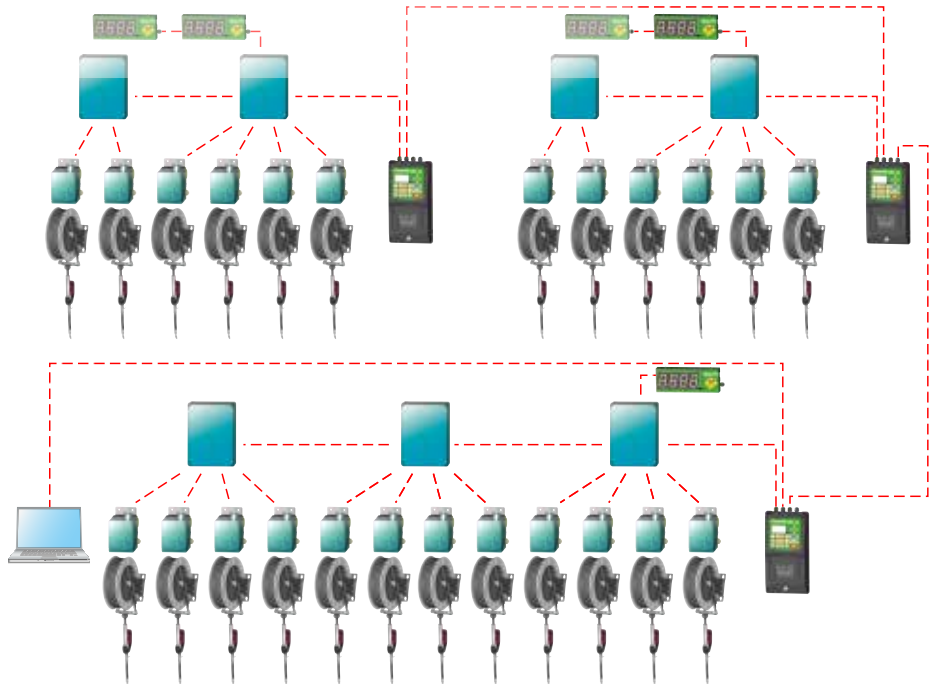

مركز البراغي والعدد
BTCO
BOLTS & TOOLS CENTER



All rights reserved to Ecodora s.r.l.

 **ECODORA**



WEDA/MO.2014-GB

 Made in Italy